

150 V power Schottky rectifier

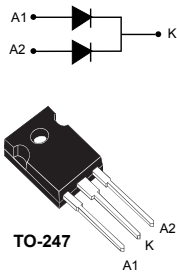

Features

- High junction temperature capability
- Low leakage current
- Good trade off between leakage current and forward voltage drop
- Low thermal resistance
- High frequency operation
- ECOPACK[®]2 compliant

Applications

- Switching diode
- SMPS
- DC/DC converter
- Telecom power

Description

This dual diode common cathode Schottky rectifier is optimized for high frequency switched mode power supplies.

Packaged in TO-247, the **STPS61150C** combines high current rating and low volume to enhance both reliability and power density of the application.

Product status	
STPS61150C	
Product summary	
$I_{F(AV)}$	2 x 30 A
V_{RRM}	150 V
$T_{j(max.)}$	175 °C
$V_{F(typ.)}$	0.63 V

1 Characteristics

Table 1. Absolute ratings (limiting values, per diode at 25 °C, unless otherwise specified)

Symbol	Parameter	Value	Unit		
V _{RRM}	Repetitive peak reverse voltage	150	V		
I _{F(RMS)}	Forward rms current	80	A		
I _{F(AV)}	Average forward current, δ = 0.5, square wave	T _c = 150 °C	Per diode	30	A
		T _c = 145 °C	Per device	60	
I _{FSM}	Surge non repetitive forward current	t _p = 10 ms sinusoidal	500	A	
P _{ARM}	Repetitive peak avalanche power	t _p = 10 μs, T _j = 125 °C	2290	W	
T _{stg}	Storage temperature range	-65 to +175	°C		
T _j	Maximum operating junction temperature ⁽¹⁾	+175	°C		

1. $(dP_{tot}/dT_j) < (1/R_{th(j-a)})$ condition to avoid thermal runaway for a diode on its own heatsink.

Table 2. Thermal resistance parameters

Symbol	Parameter	Value	Unit
R _{th(j-c)}	Junction to case	Per diode	0.9
		Total	0.6
R _{th(c)}	Coupling	0.3	°C/W

When the diodes 1 and 2 are used simultaneously: $\Delta T_j(\text{diode1}) = P_{(\text{diode1})} \times R_{th(j-c)}$ (per diode) + $P_{(\text{diode2})} \times R_{th(c)}$

For more information, please refer to the following application note :

- AN5088 : Rectifiers thermal management, handling and mounting recommendations

Table 3. Static electrical characteristics (per diode)

Symbol	Parameter	Test conditions	Min.	Typ.	Max.	Unit	
I _R ⁽¹⁾	Reverse leakage current	T _j = 25 °C	V _R = V _{RRM}	-	7	20	μA
		T _j = 125 °C		-	7	25	mA
V _F ⁽²⁾	Forward voltage drop	T _j = 25 °C	I _F = 30 A	-	-	0.84	V
		T _j = 125 °C		-	0.63	0.67	
		T _j = 25 °C	I _F = 60 A	-	-	0.92	
		T _j = 125 °C		-	0.76	0.80	

1. Pulse test: t_p = 5 ms, δ < 2%

2. Pulse test: t_p = 380 μs, δ < 2%

To evaluate the conduction losses, use the following equation: $P = 0.54 \times I_{F(AV)} + 0.0043 \times I_F^2$ (RMS)

For more information, please refer to the following application notes related to the power losses :

- AN604: Calculation of conduction losses in a power rectifier
- AN4021: Calculation of reverse losses on a power diode

1.1 Characteristics (curves)

Figure 1. Average forward power dissipation versus average forward current (per diode)

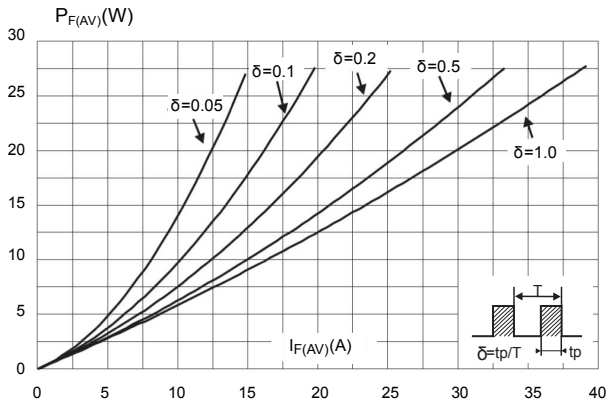

Figure 2. Average forward current versus ambient temperature ($\delta = 0.5$, per diode)

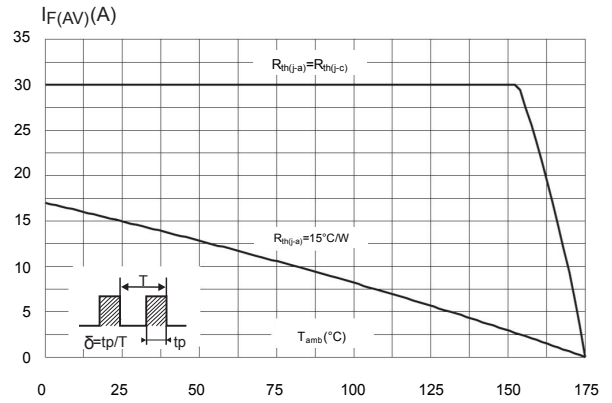

Figure 3. Normalized avalanche power derating versus pulse duration ($T_j = 125^\circ\text{C}$)

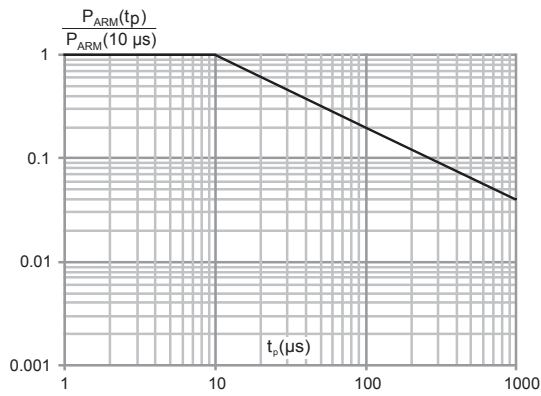

Figure 4. Relative variation of thermal impedance junction to case versus pulse duration

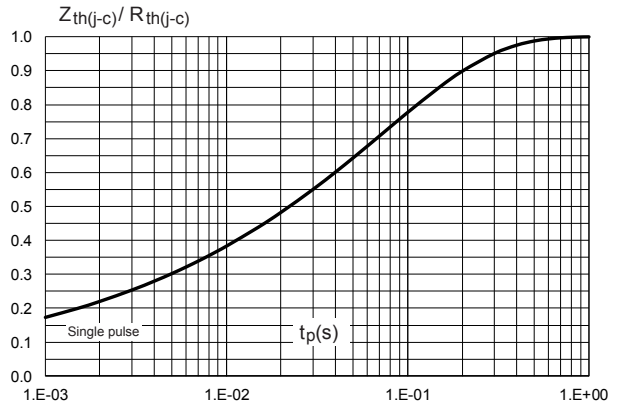

Figure 5. Reverse leakage current versus reverse voltage applied (typical values, per diode)

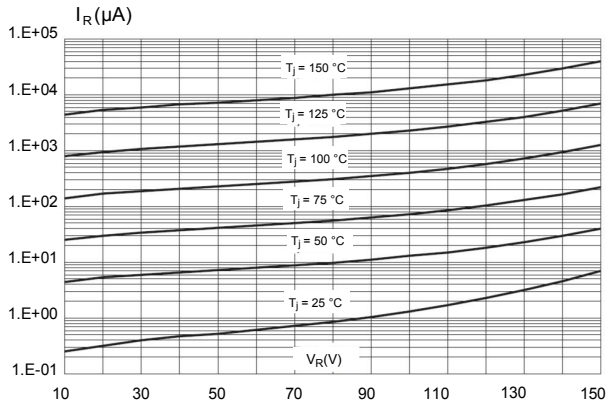

Figure 6. Junction capacitance versus reverse voltage applied (typical values, per diode)

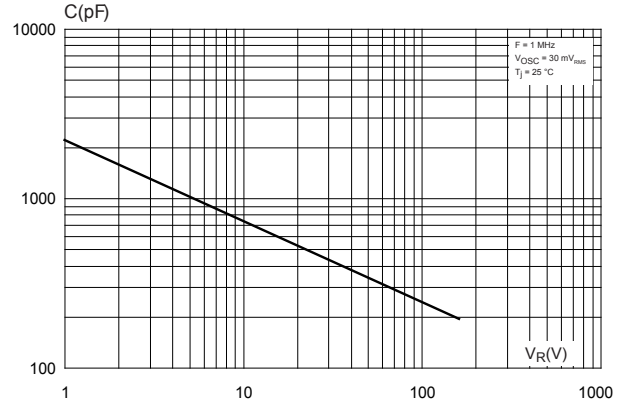
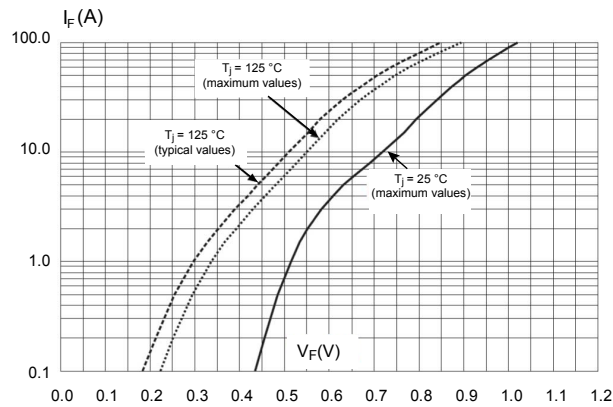

Figure 7. Forward voltage drop versus forward current (per diode)



2 Package information

In order to meet environmental requirements, ST offers these devices in different grades of ECOPACK® packages, depending on their level of environmental compliance. ECOPACK® specifications, grade definitions and product status are available at: www.st.com. ECOPACK® is an ST trademark.

2.1 TO-247 package information

- Epoxy meets UL94, V0
- Cooling method: by conduction (C)
- Recommended torque value: 0.8 N·m
- Maximum torque value: 1.0 N·m

Figure 8. TO-247 package outline

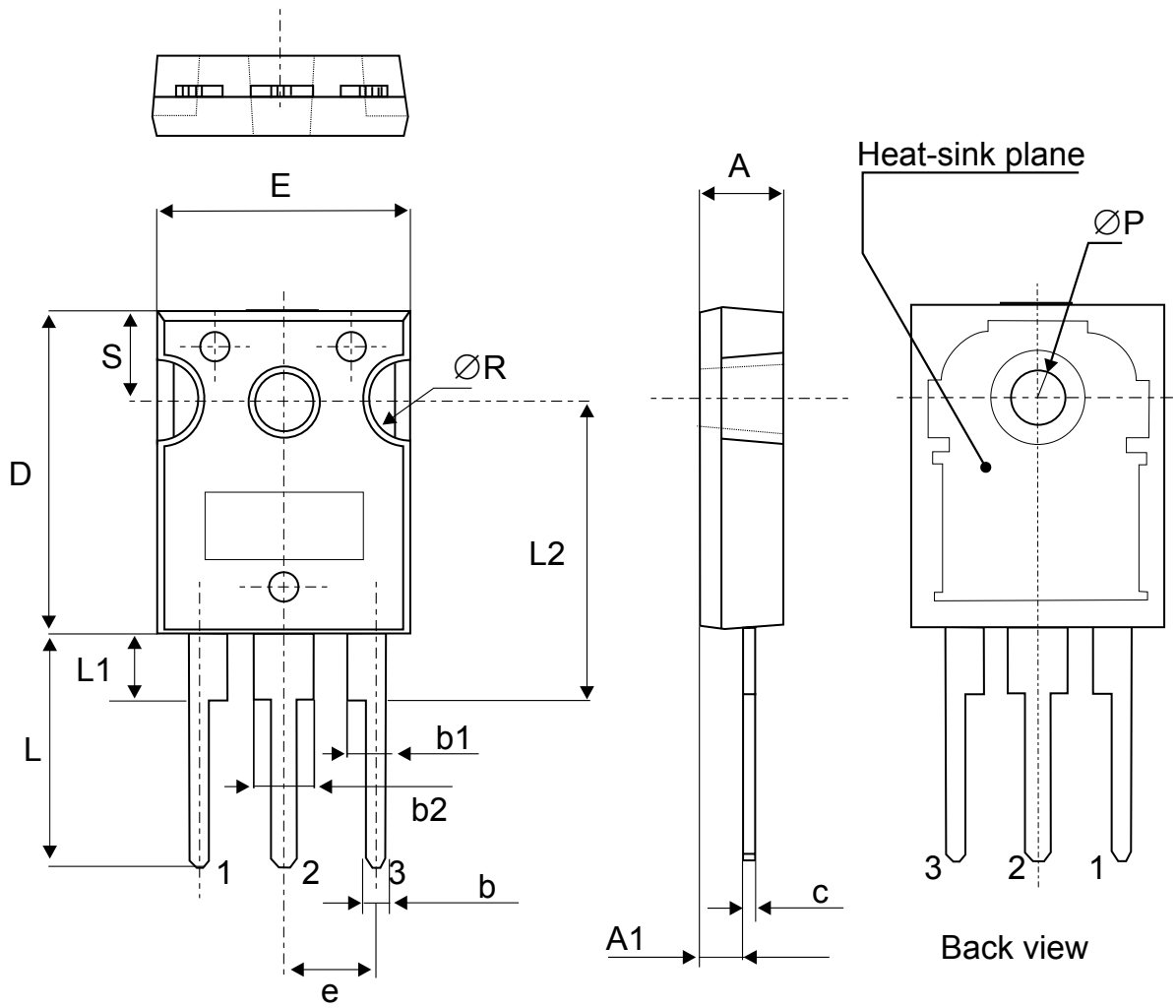

Table 4. TO-247 package mechanical data

Ref.	Dimensions					
	Millimeters			Inches (for reference only)		
	Min.	Typ.	Max.	Min.	Typ.	Max.
A	4.85		5.15	0.191		0.203
A1	2.20		2.60	0.086		0.102
b	1.00		1.40	0.039		0.055
b1	2.00		2.40	0.078		0.094
b2	3.00		3.40	0.118		0.133
c	0.40		0.80	0.015		0.031
D	19.85		20.15	0.781		0.793
E	15.45		15.75	0.608		0.620
e	5.30	5.45	5.60	0.209	0.215	0.220
L	14.20		14.80	0.559		0.582
L1	3.70		4.30	0.145		0.169
L2		18.50			0.728	
ØP	3.55		3.65	0.139		0.143
ØR	4.50		5.50	0.177		0.217
S	5.30	5.50	5.70	0.209	0.216	0.224

3 Ordering information

Table 5. Order code

Order code	Marking	Package	Weight	Base qty.	Delivery mode
STPS61150CW	STPS61150CW	TO-247	4.36 g	30	Tube

Revision history

Table 6. Document revision history

Date	Revision	Changes
24-Jul-2012	1	First issue.
27-Jun-2018	2	Updated Table 1. Absolute ratings (limiting values, per diode at 25 °C, unless otherwise specified) and Figure 3. Normalized avalanche power derating versus pulse duration ($T_j = 125\text{ °C}$).

IMPORTANT NOTICE – PLEASE READ CAREFULLY

STMicroelectronics NV and its subsidiaries (“ST”) reserve the right to make changes, corrections, enhancements, modifications, and improvements to ST products and/or to this document at any time without notice. Purchasers should obtain the latest relevant information on ST products before placing orders. ST products are sold pursuant to ST’s terms and conditions of sale in place at the time of order acknowledgement.

Purchasers are solely responsible for the choice, selection, and use of ST products and ST assumes no liability for application assistance or the design of Purchasers’ products.

No license, express or implied, to any intellectual property right is granted by ST herein.

Resale of ST products with provisions different from the information set forth herein shall void any warranty granted by ST for such product.

ST and the ST logo are trademarks of ST. All other product or service names are the property of their respective owners.

Information in this document supersedes and replaces information previously supplied in any prior versions of this document.

© 2018 STMicroelectronics – All rights reserved