

AC Filter for PCB Mounting

Standard- or Medical-Filter



Shield



Description

- Component: PCB Mounting
- 1 Function: Line filter in standard and medical version
- For PCB mounting

Approvals

- VDE Certificate Number: 101307
- UL File Number: E72928

Characteristics

- Ultra-compact design
- Shield available separately (German silver)
- Qualified for use in equipment according IEC/EN 60950

Weblinks

pdf, html, General Product Information, Approvals, RoHS, CHINA-RoHS, Mating Connectors, e-Shop, SCHURTER-Stock-Check, Distributor-Stock-Check, Accessories, Detailed request for product

Technical Data

Ratings IEC	1 - 10A @ Ta 40 °C / 250VAC; 50Hz
Ratings UL/CSA	1 - 10A @ Ta 40 °C / 125VAC; 60Hz
Leakage Current	standard < 0.5mA (250V / 60Hz) medical < 5 µA (250 V / 60 Hz)
Dielectric Strength	> 1.7kVDC between L-N > 2.7kVDC between L/N-PE Test voltage (2 sec)
Allowable Operation Temp.	-25 °C to 85 °C
Climatic Category	25/085/21 acc. to IEC 60068-1
Degree of Protection	from front side IP 40 acc. to IEC 60529
Protection Class	Suitable for appliances with protection class 1 acc. to IEC 61140
Terminal	For PCB mounting
Material: Housing	Thermoplastic, UL 94V-0

Line Filter	Standard and Medical Version, IEC 60939, IEC 60601-1, UL 1283, UL 544, EN 133 200, CSA C22.2 no. 8 Technical Details
MTBF	> 5'900'000h acc. to MIL-HB-217 F

Dimensions

Line Filter

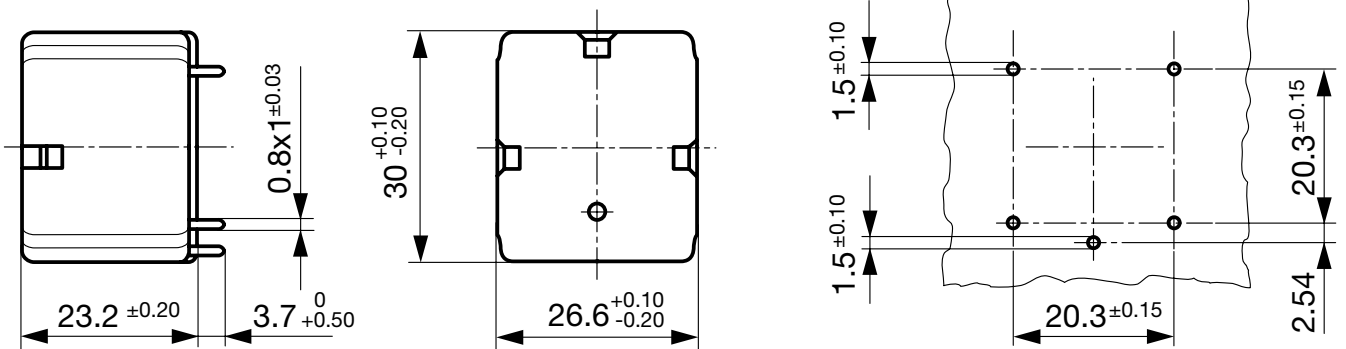

1600 A / 520 V

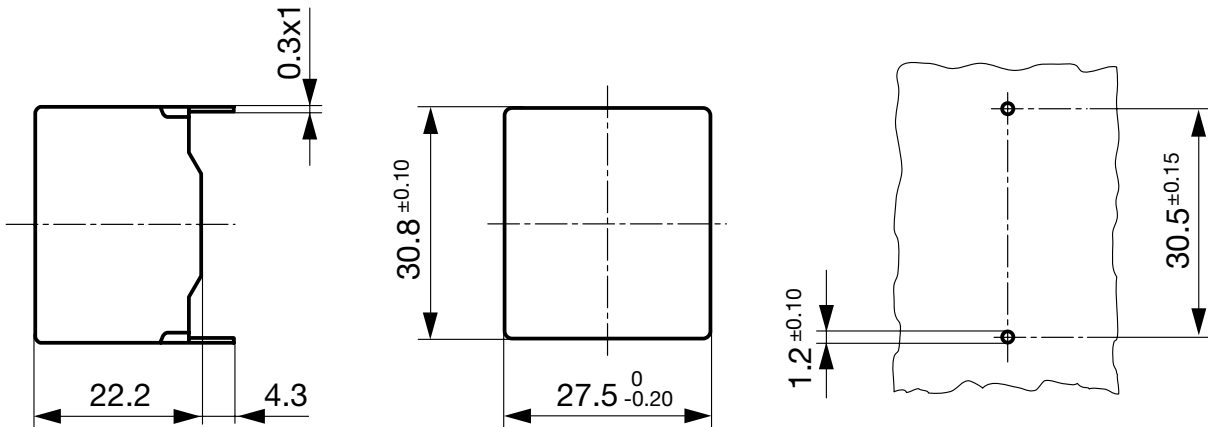

Technical Data of Filter-Components

Rated Current [A]	Filter-Type	Inductances L [mH]	Capacitance CX [nF]	Capacitance CY [nF]	R [MΩ]
1	Standard Version	2 x 11	47	2.2	-
2	Standard Version	2 x 4	47	2.2	-
4	Standard Version	2 x 1.6	47	2.2	-
6	Standard Version	2 x 0.7	47	2.2	-
8	Standard Version	2 x 0.5	47	2.2	-
10	Standard Version	2 x 0.3	47	2.2	-
1	Medical Version (M5)	2 x 11	47	-	1
2	Medical Version (M5)	2 x 4	47	-	1
4	Medical Version (M5)	2 x 1.6	47	-	1
6	Medical Version (M5)	2 x 0.7	47	-	1
8	Medical Version (M5)	2 x 0.5	47	-	1
10	Medical Version (M5)	2 x 0.3	47	-	1

Diagrams

Standard version

Medical version

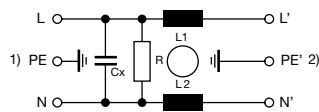
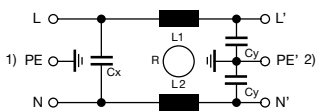

1) Line
2) Load

1) Line
2) Load

Attenuation Loss

---- differential mode ____ common mode

Standard version

1 A

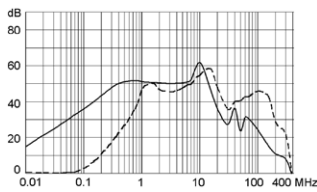

2 A

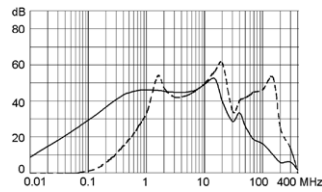

4 A

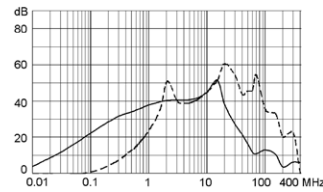

6 A

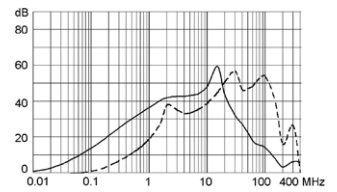

8 A

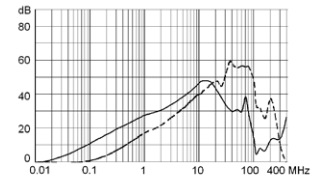

10 A

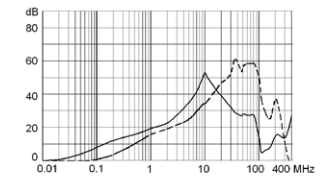

Medical version (M5)

1 A

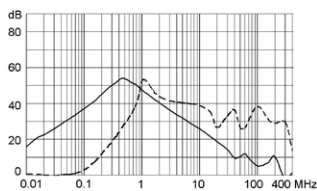

2 A

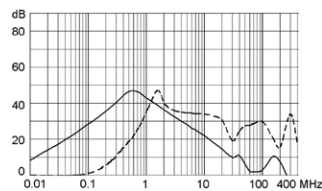

4 A

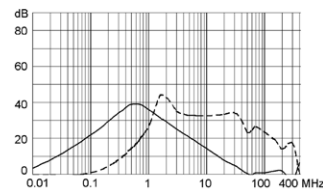

6 A

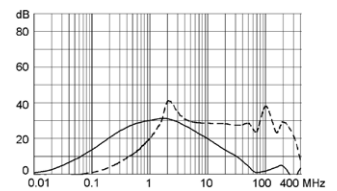

8 A

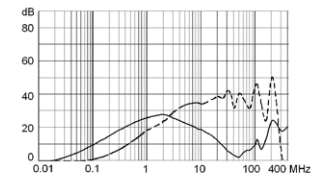

10 A

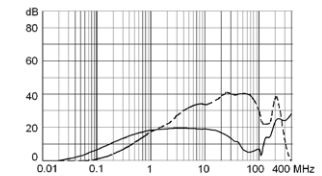

Variants

Rated Current [A]	Filter-Type	EMC-Shielding	Weight [g]	Order Number
-	-	Shield	-	5500.0001
1	Standard Version	Without EMC-shield	-	5500.0155.1
2	Standard Version	Without EMC-shield	-	5500.0255.1
4	Standard Version	Without EMC-shield	-	5500.0455.1
6	Standard Version	Without EMC-shield	-	5500.0655.1
8	Standard Version	Without EMC-shield	-	5500.0855.1
10	Standard Version	Without EMC-shield	-	5500.1055.1
1	Medical Version (M5)	Without EMC-shield	-	5500.0155.3
2	Medical Version (M5)	Without EMC-shield	-	5500.0255.3
4	Medical Version (M5)	Without EMC-shield	-	5500.0455.3
6	Medical Version (M5)	Without EMC-shield	-	5500.0655.3
8	Medical Version (M5)	Without EMC-shield	-	5500.0855.3
10	Medical Version (M5)	Without EMC-shield	-	5500.1055.3

Packaging unit 100 Pcs