

REV.	DESCRIPTION	DRAWN	DATE
2	Add A & E Key SPEC.	FROS	2018/10/09
3	CORRECTED	TIM	2019/06/10
3.1	CORRECTED	TIM	2019/12/11

Notes:

Material:

- Housing: High Temperature Thermoplastic, UL94V-0, Black
- Contacts: Copper Alloy, gold plated on contact area and gold flash solder area. 50u" min nickel under-plating overall.
- △ Peg: Copper Alloy, 50~120u" min matte-tin plated on soldering area. 50u" min. nickel under-plating.
- Reflow Solder Capable to 260°C
- Datecode: YYWWD
- How to order:

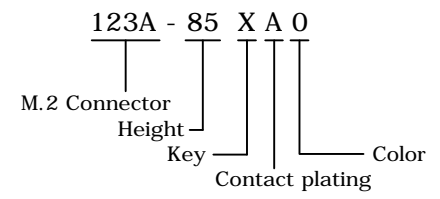

DIMENSION TABLE								
P/N	Key	DIM.A	DIM.B	DIM.C	DIM.D	DIM.E	DIM.F	DIM.G
123A-85MA0	M	-6.125	14.0	2.0	14.0	1.5	1.125	1.375
123A-85EA0	E	2.625	5.5	10.5	5.0	10.5	1.375	1.125
123A-85BA0	B	5.625	2.5	13.5	2.0	13.5	1.375	1.125
123A-85AA0	A	6.625	1.5	14.5	1.0	14.5	1.125	1.375

UNLESS OTHERWISE SPECIFIED TOLERANCE			
UNIT:	DECIMAL	LINEAR	ANGLES
mm	X.	±0.50	±5°
	X.X	±0.25	±3°
	X.XX	±0.12	±1°

DRAWN	Fros	2015/04/13	DRAWN NAME:	M2 CONNECTOR			
CHECKED	Zola	2015/04/13		A,B,E,M KEY, 0.5 PITCH, 8.5H			
APPROVED	Albert	2015/04/13	PRODUCT NO.	SEE TABLE			
SCALE	3.5	SHEET	1/6	SIZE	A4	FILE NAME	123A-85XA0_B_3.1

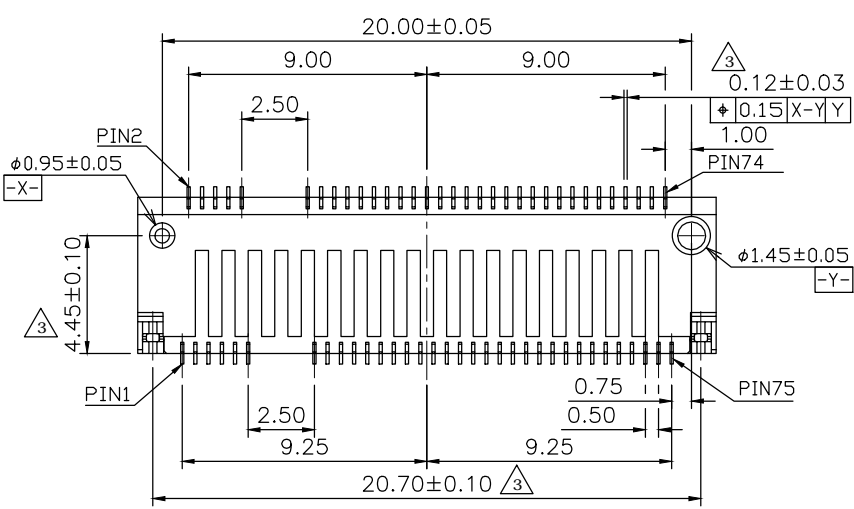
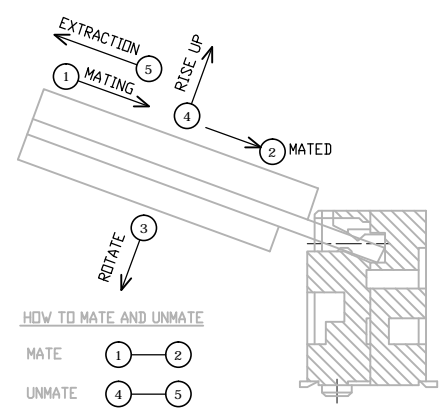
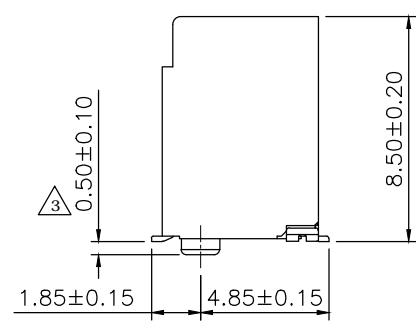
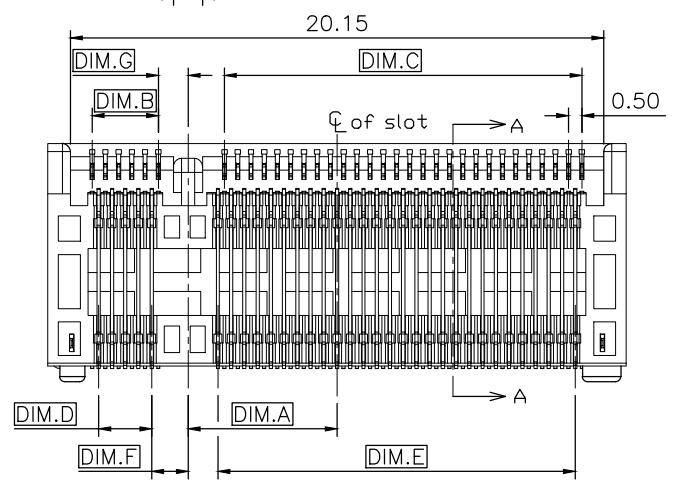
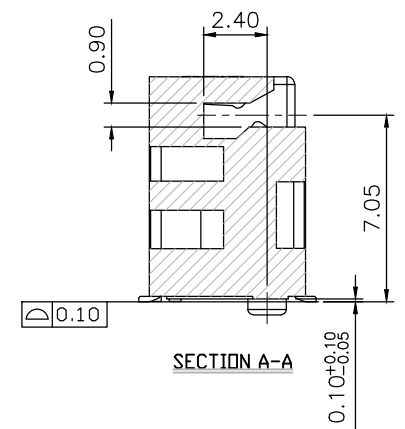
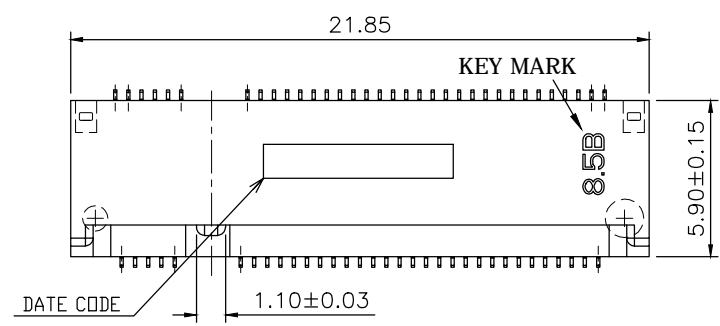

REV.	DESCRIPTION	DRAWN	DATE
	see sheet one		

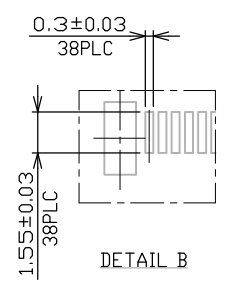
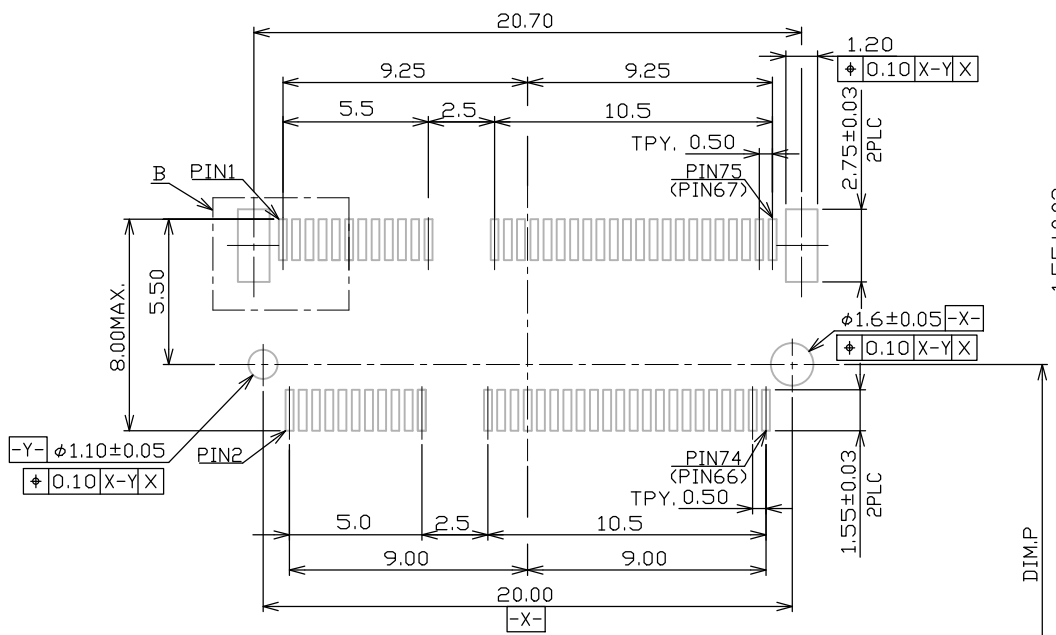
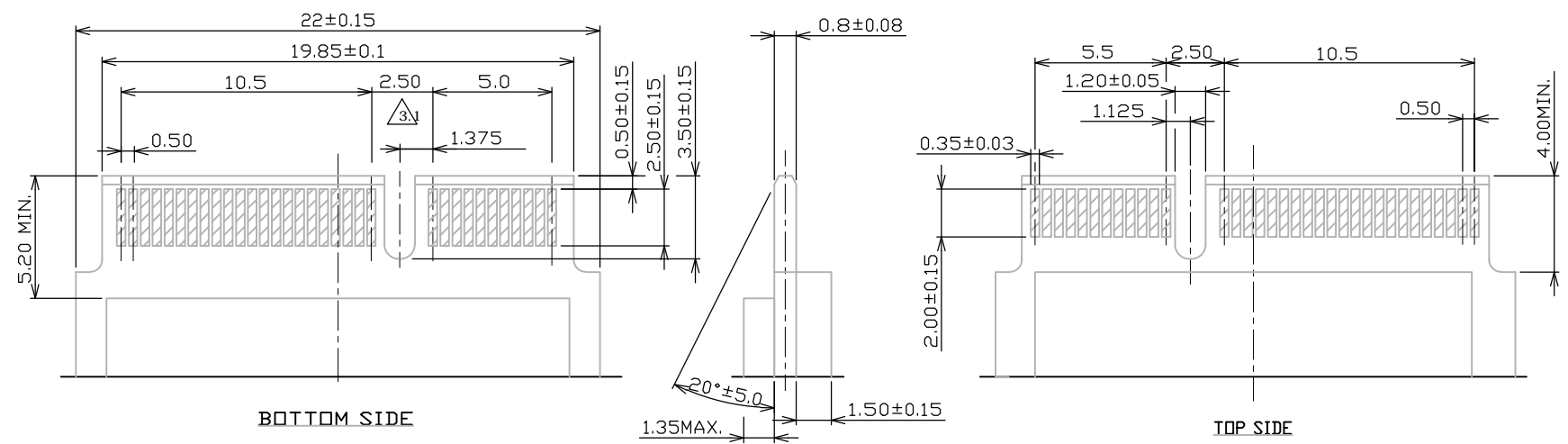

107.60	22110
77.60	2280
57.60	2260
39.60	2242
27.60	2230
39.60	3042
27.60	3030
DIM.P	MODULE TYPE

RECOMMENDED P.C.BOARD LAYOUT

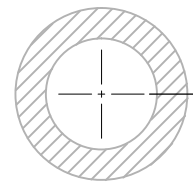

UNLESS OTHERWISE SPECIFIED TOLERANCE							
UNIT:	DECIMAL	LINEAR	ANGLES				
mm	X.	±0.50	±5°				
	X.X	±0.25	±3°				
	X.XX	±0.12	±1°				
DRAWN	Fros	2015/04/13	DRAWN NAME: LAYOUT, M2 CONNECTOR E-KEY, 0.5 PITCH, 8.5H				
CHECKED	Zola	2015/04/13					
APPROVED	Albert	2015/04/13					
SCALE	3.5	SHEET	4/6	SIZE	A4	FILE NAME	123A-85XA0_B_3.1

ATTEND

WWW.ATTEND.COM.TW

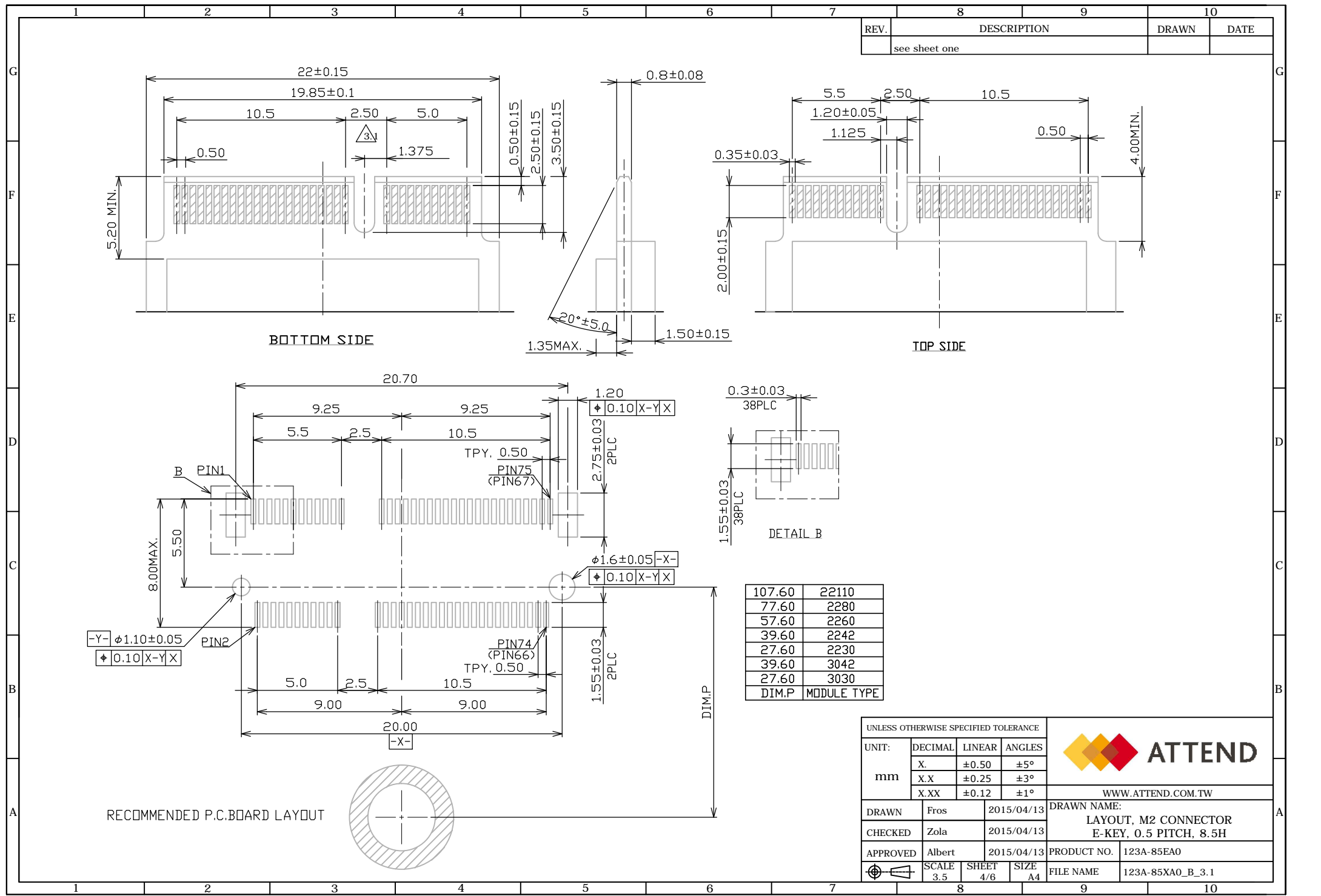

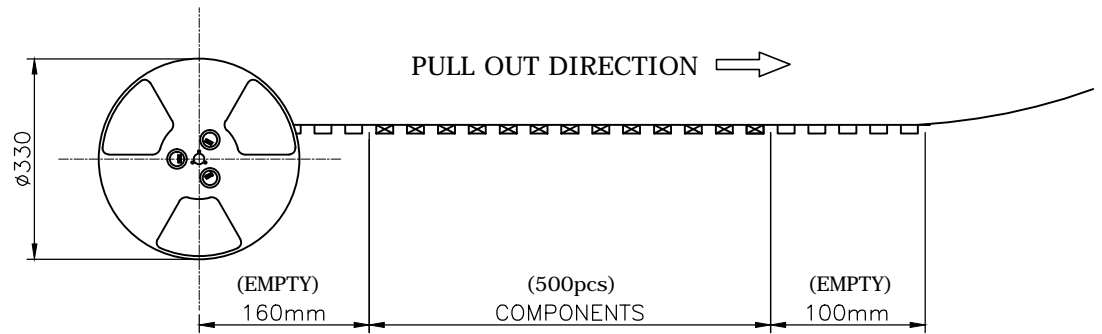

REV.	DESCRIPTION	DRAWN	DATE
	see sheet one		

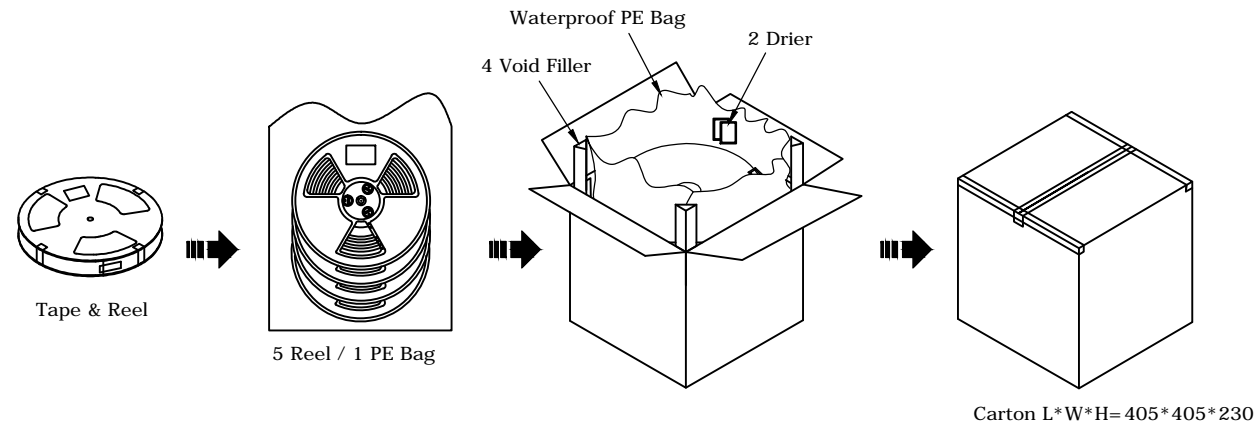
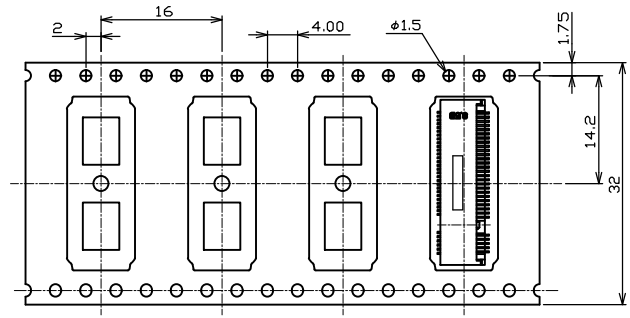

PACKAGING SPECIFICATION:

Quantity:
 500 Piece/ Reel
 5 Reel/ Carton
 2,500 Piece/ Outer Carton



UNLESS OTHERWISE SPECIFIED TOLERANCE				 WWW.ATTEND.COM.TW
UNIT:	DECIMAL	LINEAR	ANGLES	
mm	X.	±0.50	±5°	
	X.X	±0.25	±3°	
	X.XX	±0.12	±1°	
DRAWN	Fros	2015/04/13	DRAWN NAME:	
CHECKED	Zola	2015/04/13	PACKAGING, M2 CONNECTOR A,B,E,M-KEY, 0.5 PITCH, 8.5H	
APPROVED	Albert	2015/04/13	PRODUCT NO. see table	
	SCALE N/A	SHEET 6/6	SIZE A4	FILE NAME 123A-85XA0_B_3.1