

0.025" [0.64mm] Centerline PVC IDC Ribbon Cable

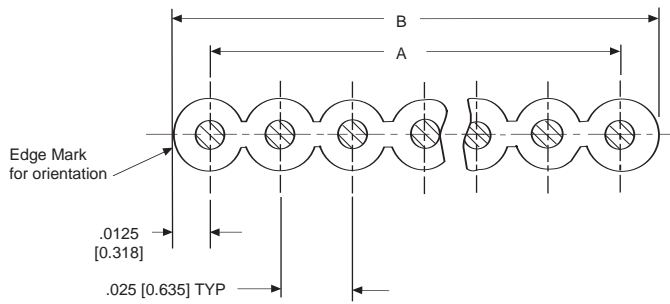

Product Specifications

- ▲ Insulation: PVC
- ▲ Voltage Rating: 150 Volts
- ▲ UL Recognized: AWM Style 2678
- ▲ CSA Certification: AWM 1A FTI

**Electrical Specifications
30 AWG Solid Bare Copper**

- ▲ Impedance (Ohms): 80
- ▲ Capacitance (pf/ft): 23.0
- ▲ Crosstalk:
 - ▲ Near End: 4.0%
 - ▲ Far End: 6.0%
- ▲ Propagation Delay ns/ft: 1.51

30 AWG 7/38 Tin Plated Copper

- ▲ Impedance (Ohms): 70
- ▲ Capacitance (pf/ft): 22.0
- ▲ Crosstalk:
 - ▲ Near End: 5.2%
 - ▲ Far End: 6.9%
- ▲ Propagation Delay ns/ft: 1.55

No. of Cond.	Dimensions		Roll Length	Part Number	Spec Number
	A	B			
30 AWG Solid Bare Copper - 0.025 [.64]					
20	0.475 [12.07]	0.500 [12.70]	100 ft.	1-57013-3	100-4136
40	0.975 [24.77]	1.000 [25.40]	100 ft.	1-57013-7	100-4136
50	1.225 [31.12]	1.250 [31.75]	100 ft.	1-57013-9	100-4136
68	1.675 [42.55]	1.700 [43.18]	100 ft.	2-57013-1	100-4136
80	1.975 [50.17]	2.000 [50.80]	100 ft.	2-57013-3	100-4136
100	2.475 [62.87]	2.500 [63.50]	100 ft.	2-57013-4	100-4136
20	0.475 [12.07]	0.500 [12.70]	500 ft.	57013-1	100-4136
40	0.975 [24.77]	1.000 [25.40]	500 ft.	57013-2	100-4136
50	1.225 [31.12]	1.250 [31.75]	500 ft.	1-57013-0	100-4136
68	1.675 [42.55]	1.700 [43.18]	500 ft.	1-57013-1	100-4136
80	1.975 [50.17]	2.000 [50.80]	500 ft.	57013-4	100-4136
100	2.475 [62.87]	2.500 [63.50]	500 ft.	57013-5	100-4136
30 AWG 7/38 Tin Plated Copper - 0.025 [.64]					
20	0.475 [12.07]	0.500 [12.70]	100 ft.	1-57131-3	100-7147
40	0.975 [24.77]	1.000 [25.40]	100 ft.	1-57131-7	100-7147
50	1.225 [31.12]	1.250 [31.75]	100 ft.	1-57131-9	100-7147
68	1.675 [42.55]	1.700 [43.18]	100 ft.	2-57131-1	100-7147
80	1.975 [50.17]	2.000 [50.80]	100 ft.	2-57131-3	100-7147
100	2.475 [62.87]	2.500 [63.50]	100 ft.	2-57131-4	100-7147
20	0.475 [12.07]	0.500 [12.70]	500 ft.	57131-1	100-7147
40	0.975 [24.77]	1.000 [25.40]	500 ft.	57131-2	100-7147
50	1.225 [31.12]	1.250 [31.75]	500 ft.	1-57131-0	100-7147
68	1.675 [42.55]	1.700 [43.18]	500 ft.	1-57131-1	100-7147
80	1.975 [50.17]	2.000 [50.80]	500 ft.	57131-4	100-7147
100	2.475 [62.87]	2.500 [63.50]	500 ft.	57131-5	100-7147

Other Conductor Counts Available on Request.

Standard Flat Ribbon
Cables

0.025" [0.64mm] Centerline FEP IDC Ribbon Cable

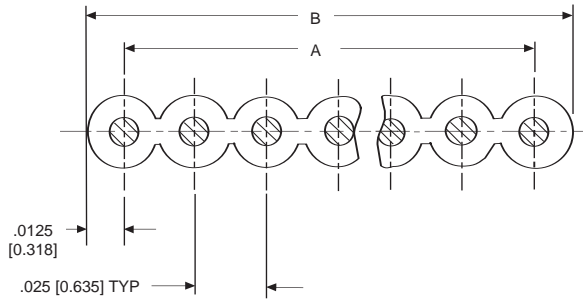

Product Specifications

- ▲ Insulation: FEP
- ▲ Voltage Rating: 150 Volts
- ▲ UL Recognized: AWM Style 20726
- ▲ CSA Certification: AWM 1A FT1
- ▲ Color: Opaque w/Blue Edge Mark

Electrical Specifications

30 AWG Solid Bare Copper

- ▲ Impedance (Ohms): 90
- ▲ Capacitance (pf/ft): 14.7
- ▲ Crosstalk:
 - ▲ Near End: 2.6%
 - ▲ Far End: 2.1%

30 AWG 7/38 Silver Plated Copper

- ▲ Impedance (Ohms): 85
- ▲ Capacitance (pf/ft): 15.5
- ▲ Crosstalk:
 - ▲ Near End: 2.5%
 - ▲ Far End: 2.1%

30 AWG 7/40 Silver Plated Copper

- ▲ Impedance (Ohms): 95
- ▲ Capacitance (pf/ft): 13.5
- ▲ Crosstalk:
 - ▲ Near End: 2.8%
 - ▲ Far End: 2.0%

No. of Cond.	Dimensions		Roll Length	Part Number	Spec Number
	A	B			
30 AWG Solid Silver Plated Copper - 0.025 [.64]					
10	0.225 [5.72]	0.250 [6.35]	100 ft	102BY00002	100-4907
20	0.475 [12.07]	0.500 [12.70]	100 ft	202BY00002	100-4907
40	0.975 [24.77]	1.000 [24.50]	100 ft	402BY00011	100-4907
50	1.225 [31.12]	1.250 [31.75]	100 ft	502BY00002	100-4907
64	1.675 [42.55]	1.700 [43.18]	100 ft	642BY00012	100-4907
68	1.675 [42.55]	1.700 [43.18]	100 ft	682BY00012	100-4907
80	1.975 [50.17]	2.000 [50.80]	100 ft	802BY00010	100-4907
30 AWG 7/38 Silver Plated Copper - 0.025 [.64]					
10	0.225 [5.72]	0.250 [6.35]	100 ft	102BY00001	100-4428
20	0.475 [12.07]	0.500 [12.70]	100 ft	202BY00010	100-4428
40	0.975 [24.77]	1.000 [24.50]	100 ft	402BY00010	100-4428
50	1.225 [31.12]	1.250 [31.75]	100 ft	502BY00011	100-4428
64	1.675 [42.55]	1.700 [43.18]	100 ft	642BY00001	100-4428
68	1.675 [42.55]	1.700 [43.18]	100 ft	682BY00011	100-4428
80	1.975 [50.17]	2.000 [50.80]	100 ft	802BY00011	100-4428
32 AWG 7/40 Silver Plated Copper - 0.025 [.64]					
10	0.225 [5.72]	0.250 [6.35]	100 ft	102AY00001	100-4952
20	0.475 [12.07]	0.500 [12.70]	100 ft	202AY00001	100-4952
40	0.975 [24.77]	1.000 [24.50]	100 ft	402AY00002	100-4952
50	1.225 [31.12]	1.250 [31.75]	100 ft	502AY00002	100-4952
64	1.675 [42.55]	1.700 [43.18]	100 ft	642AY00001	100-4952
68	1.675 [42.55]	1.700 [43.18]	100 ft	682AY00001	100-4952
80	1.975 [50.17]	2.000 [50.80]	100 ft	802AY00001	100-4952

Other Conductor Counts Available on Request

Standard Flat Ribbon Cables

0.025" [0.64mm] Centerline TPO IDC Ribbon Cable

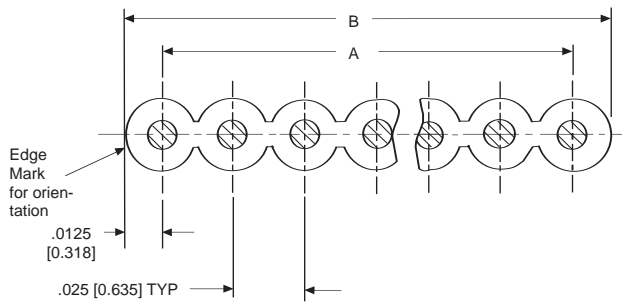

Product Specifications

- ▲ Insulation: TPO
- ▲ Voltage Rating: 150 Volts
- ▲ UL Recognized: AWM Style 20297
- ▲ CSA Certification: AWM 1A FTI
- ▲ Color: Natural

No. of Cond.	Dimensions		Roll Length	Part Number	Spec Number
	A	B			
31 AWG 7/39 Tin Plated Copper - 0.025 [.64]					
68	1.675 [42.55]	1.700 [43.18]	300 ft.	1-219253-1	15400
30 AWG Solid Bare Copper - 0.025 [.64]					
68	1.675 [42.55]	1.700 [43.18]	300 ft.	1-219054-1	100-7444
Other Conductor Counts Available on Request					
30 AWG 7/38 Tin Plated Copper - 0.025 [.64]					
68	1.675 [42.55]	1.700 [43.18]	300 ft.	1-219055-1	100-7491

Electrical Specifications
31 AWG 7/39 Tin Plated Copper

- ▲ Impedance (Ohms): 90
- ▲ Capacitance (pf/ft): 15.4
- ▲ Crosstalk:
 - ▲ Near End: 2.4%
 - Far End: 3.0%

30 AWG Solid Bare Copper

- ▲ Impedance (Ohms): 90
- ▲ Capacitance (pf/ft): 15.3
- ▲ Crosstalk:
 - ▲ Near End: 2.4%
 - Far End: 3.0%

30 AWG 7/38 Tin Plated Copper

- ▲ Impedance (Ohms): 80
- ▲ Capacitance (pf/ft): 19.5
- ▲ Crosstalk:
 - ▲ Near End: 2.4%
 - Far End: 3.0%

Standard Flat Ribbon Cables

0.050" [1.27mm] Centerline Flat PVC and TPO IDC Ribbon Cable

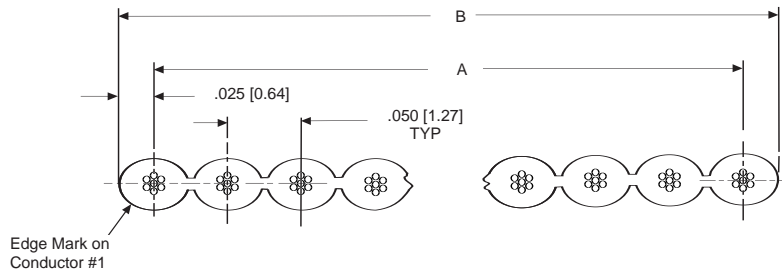

Product Specifications

- ▲ Voltage Rating: 300 Volts
- ▲ UL Recognized: AWM Style 2651 or 20297
- ▲ CSA: AWM 1A FTI

Standard Flat Ribbon Cables

No. of Cond.	Dimensions		Roll Length	Part Number	Spec Number
	A	B			
28 AWG 7/36 Tin Plated Copper - PVC Insulation - 0.035 [.89]					
9	0.400 [10.16]	0.450 [11.43]	100 ft.	1-57040-2	100-4703
10	0.450 [11.43]	0.500 [12.70]	100 ft.	1-57040-3	100-4703
20	0.950 [24.13]	1.000 [25.40]	100 ft.	57040-1	100-4703
34	1.650 [41.91]	1.700 [43.18]	100 ft.	57040-4	100-4703
40	1.950 [49.53]	2.000 [50.80]	100 ft.	57040-5	100-4703
50	2.450 [62.23]	2.500 [63.50]	100 ft.	57040-6	100-4703
60	2.950 [74.93]	3.000 [76.20]	100 ft.	57040-7	100-4703
64	3.150 [80.01]	3.200 [81.28]	100 ft.	2-57040-2	100-4703
9	0.400 [10.16]	0.450 [11.43]	500 ft.	1-971111-2	100-4703
10	0.450 [11.43]	0.500 [12.70]	500 ft.	1-971111-3	100-4703
20	0.950 [24.13]	1.000 [25.40]	500 ft.	971111-1	100-4703
34	1.650 [41.91]	1.700 [43.18]	500 ft.	971111-4	100-4703
40	1.950 [49.53]	2.000 [50.80]	500 ft.	971111-5	100-4703
50	2.450 [62.23]	2.500 [63.50]	500 ft.	971111-6	100-4703
60	2.950 [74.93]	3.000 [76.20]	500 ft.	971111-7	100-4703
64	3.150 [80.01]	3.200 [81.28]	500 ft.	2-971111-2	100-4703
28 AWG 7/36 Tin Plated Copper - TPO Insulation - 0.035 [.89]					
14	0.650 [16.51]	0.700 [17.80]	300 ft.	219350-4	100-6257
34	1.650 [41.91]	1.700 [43.18]	300 ft.	219350-3	100-6257
40	1.950 [49.53]	2.000 [50.80]	300 ft.	219350-2	100-6257
50	2.450 [62.23]	2.500 [63.50]	300 ft.	219350-1	100-6257
26 AWG 7/34 Tin Plated Copper - PVC Insulation - 0.039 [.99]					
9	0.400 [10.16]	0.450 [11.43]	500 ft.	57034-2	100-7077
10	0.450 [11.43]	0.500 [12.70]	500 ft.	57034-3	100-7077
20	0.950 [24.13]	1.000 [25.40]	500 ft.	57034-7	100-7077
34	1.650 [41.91]	1.700 [43.18]	500 ft.	1-57034-1	100-7077
40	1.950 [49.53]	2.000 [50.80]	500 ft.	1-57034-4	100-7077
50	2.450 [62.23]	2.500 [63.50]	500 ft.	1-57034-5	100-7077
60	2.950 [74.93]	3.000 [76.20]	500 ft.	1-57034-6	100-7077
64	3.150 [80.01]	3.200 [81.28]	500 ft.	2-57034-5	100-7077

Other Conductor Counts Available on Request

0.050" [1.27mm] Centerline Flat FEP IDC Ribbon Cable

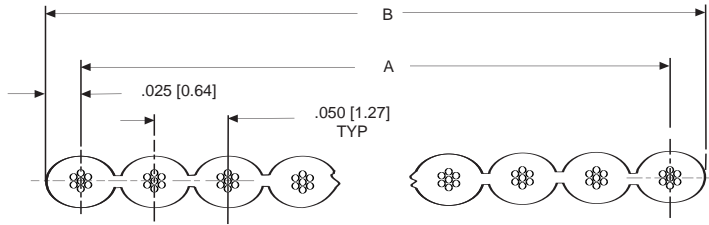

Product Specifications

- ▲ Insulation: FEP
- ▲ Temperature Rating: -65°C to +200°C
- ▲ Voltage Rating: 300 Volts
- ▲ UL Recognized: AWM Style 20424

Electrical Specifications

28 AWG 7/36 Silver Plated Copper

- ▲ Impedance (Ohms): 115
- ▲ Capacitance (pf/ft): 10
- ▲ Crosstalk:
 - ▲ Near End: 3.0%
 - ▲ Far End: 2.8%

26 AWG 7/34 Silver Plated Copper

- ▲ Impedance (Ohms): 100
- ▲ Capacitance (pf/ft): 11.5
- ▲ Crosstalk:
 - ▲ Near End: 2.8%
 - ▲ Far End: 2.8%

No. of Cond.	Dimensions		Roll Length	Part Number	Spec Number
	A	B			
28 AWG 7/36 Silver Plated Copper - 0.035 [.89]					
10	0.450 [11.43]	0.500 [12.70]	100 FT	102DY00016	100-4673
20	0.950 [24.13]	1.000 [25.40]	100 FT	202DY00015	100-4673
40	1.950 [49.53]	2.000 [50.80]	100 FT	402DY00016	100-4673
64	3.150 [80.01]	3.200 [81.28]	100 FT	642DY00012	100-4673

Other Conductor Counts Available on Request

No. of Cond.	Dimensions		Roll Length	Part Number	Spec Number
	A	B			
26 AWG 7/34 Silver Plated Copper - 0.032 [.81]					
10	0.450 [11.43]	0.500 [12.70]	100 FT	102EY00002	100-5021
20	0.950 [24.13]	1.000 [25.40]	100 FT	202EY00001	100-5021
40	1.950 [49.53]	2.000 [50.80]	100 FT	402EY00001	100-5021
64	3.150 [80.01]	3.200 [81.28]	100 FT	642DY00002	100-5021

Other Conductor Counts Available on Request

Standard Flat Ribbon Cables

Electronics

0.8 mm [0.0315"] Centerline PVC Insulation Ribbon Cable

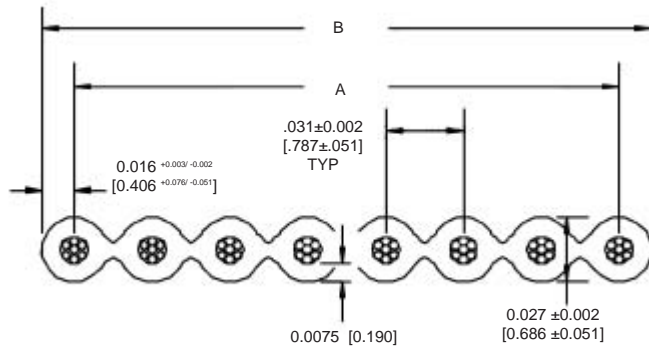

Product Specifications

- ▲ Insulation: PVC
- ▲ Impedance, GSG: 90 Ohms
- ▲ Capacitance, GSG: 21.0 ft/ft
- ▲ Crosstalk:
 - ▲ Near End: 3.25%
 - ▲ Far End: 3.31%
- ▲ Propagation Delay: 1.49 ns/ft
- ▲ Voltage Rating: 150 Volts
- ▲ UL Recognized: 2678
- ▲ CSA: AWM 1A FT1
- ▲ Color: Gray

No. of Cond.	Dimensions		Roll Length	Part Number	Spec Number
	A	B			
30 AWG 7/38 Tin Plated Copper - 0.027 [.68]					
10	0.279 [7.09]	0.31 [7.87]	100 ft	1284416-1	100-6364
20	0.589 [14.96]	0.62 [15.75]	100 ft	1284417-1	100-6364
40	1.21 [30.73]	1.24 [31.50]	100 ft	1284418-1	100-6364

Other Conductor Counts Available on Request

Standard Flat Ribbon Cables

1 mm [0.0394"] Centerline PVC IDC Ribbon Cable

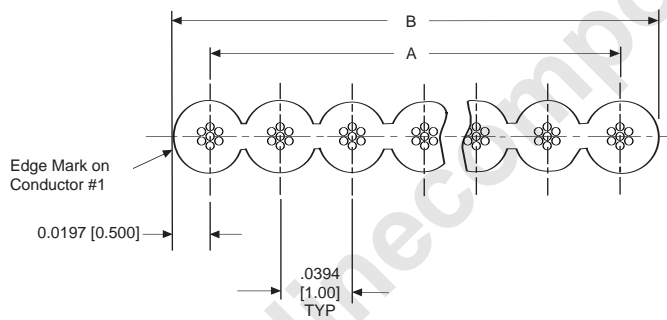

Product Specifications

- ▲ Insulation: PVC
- ▲ Impedance, GSG: 90 Ohms
- ▲ Capacitance, GSG: 16.5 ft/ft
- ▲ Crosstalk:
 - ▲ Near End: 4.0%
 - ▲ Far End: 6.0%
- ▲ Propagation Delay: 1.47 ns/ft
- ▲ Voltage Rating: 150 Volts
- ▲ UL Recognized: AWM Style 2678

No. of Cond.	Dimensions		Roll Length	Part Number	Spec Number
	A	B			
28 AWG 7/36 Tin Plated Copper - 0.031 [.79]					
6	0.197 [5.00]	0.236 [6.00]	100 ft.	1-57051-7	100-7096
10	0.354 [9.00]	0.394 [10.00]	100 ft.	1-57051-9	100-7096
12	0.433 [11.00]	0.472 [12.00]	100 ft.	5-57051-2	100-7096
20	0.748 [19.00]	0.787 [20.00]	100 ft.	2-57051-2	100-7096
40	1.535 [39.00]	1.575 [40.00]	100 ft.	2-57051-7	100-7096
44	1.693 [43.00]	1.732 [44.00]	100 ft.	2-57051-8	100-7096
50	1.929 [49.00]	1.969 [50.00]	100 ft.	2-57051-9	100-7096
6	0.197 [5.00]	0.236 [6.00]	500 ft.	57051-1	100-7096
10	0.354 [9.00]	0.394 [10.00]	500 ft.	57051-3	100-7096
12	0.433 [11.00]	0.472 [12.00]	500 ft.	5-57051-3	100-7096
20	0.748 [19.00]	0.787 [20.00]	500 ft.	57051-6	100-7096
40	1.535 [39.00]	1.575 [40.00]	500 ft.	1-57051-1	100-7096
44	1.693 [43.00]	1.732 [44.00]	500 ft.	1-57051-2	100-7096
50	1.929 [49.00]	1.969 [50.00]	500 ft.	1-57051-3	100-7096

Other Conductor Counts Available on Request

1 mm [0.0394"] Centerline FEP Insulation IDC Ribbon Cable

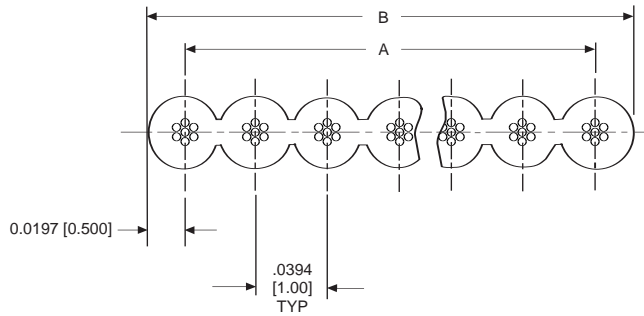

Product Specifications

- ▲ Insulation: FEP
- ▲ Impedance, GSG: 100 Ohms
- ▲ Capacitance, GSG: 12.0 ft/ft
- ▲ Crosstalk:
 - ▲ Near End: 2.8%
 - ▲ Far End: 2.5%
- ▲ Propagation Delay: 1.21 ns/ft
- ▲ Voltage Rating: 300 Volts
- ▲ UL Recognized: AWM Style 20424
- ▲ Color: Blue

No. of Cond.	Dimensions		Roll Length	Part Number	Spec Number
	A	B			
28 AWG 7/36 Silver Plated Copper - 0.031 [.79]					
10	0.354 [9.00]	0.394 [10.00]	100 Ft	102DY00017	100-5109
20	0.748 [19.00]	0.787 [20.00]	100 Ft	202DY00016	100-5109
30	1.143 [29.00]	1.182 [30.00]	100 Ft	302DY00013	100-5109
40	1.535 [39.00]	1.575 [40.00]	100 Ft	402DY00017	100-5109
50	1.929 [49.00]	1.969 [50.00]	100 Ft	502DY00015	100-5109
80	3.110 [79.00]	3.150 [80.00]	100 Ft	802DY00001	100-5109

Other Conductor Counts Available on Request

Standard Flat Ribbon Cables

0.100" [2.54 mm] Centerline IDC Ribbon Cable, PVC Insulation

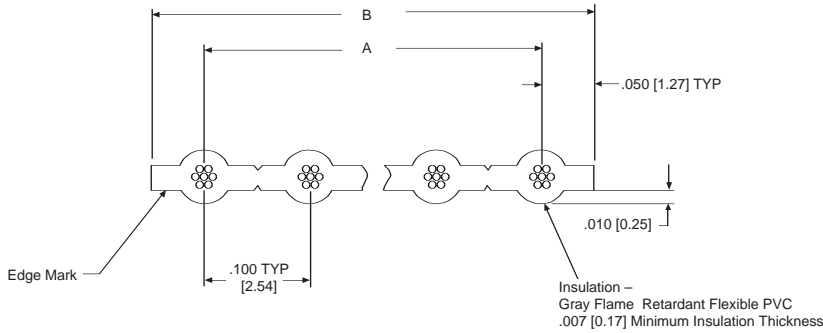

Product Specifications

- ▲ Voltage Rating: 300 Volts
- ▲ UL Recognized: AWM Style 2651
- ▲ CSA: AWM IA FTI
- ▲ Temperature Rating: -20°C to +105°C
- ▲ Flammability: UL: VW1

Standard Flat Ribbon Cables

No. of Cond.	Dimensions		Roll Length	Part Number	Spec Number
	A	B			
26 AWG 7/34 Tin Plated Copper - 0.035 [.89]					
5	0.400 [10.16]	0.500 [12.70]	250 ft	57744-5	100-7244
10	0.900 [22.86]	1.000 [25.40]	250 ft	1-57744-0	100-7244
15	1.400 [35.56]	1.500 [38.10]	250 ft	1-57744-5	100-7244
20	1.900 [48.26]	2.000 [50.80]	250 ft	2-57744-0	100-7244
25	2.400 [60.96]	2.500 [63.50]	250 ft	2-57744-5	100-7244
28	2.700 [68.58]	2.800 [71.12]	250 ft	2-57744-8	100-7244
26 AWG 7/34 Overcoated Tin Plated Copper - 0.039 [.99]					
5	0.400 [10.16]	0.500 [12.70]	250 ft	57745-5	100-7245
10	0.900 [22.86]	1.000 [25.40]	250 ft	1-57745-0	100-7245
15	1.400 [35.56]	1.500 [38.10]	250 ft	1-57745-5	100-7245
20	1.900 [48.26]	2.000 [50.80]	250 ft	2-57745-0	100-7245
25	2.400 [60.96]	2.500 [63.50]	250 ft	2-57745-5	100-7245
28	2.700 [68.58]	2.800 [71.12]	250 ft	2-57745-8	100-7245
24 AWG 7/32 Tin Plated Copper - 0.044 [1.12]					
5	0.400 [10.16]	0.500 [12.70]	250 ft	57746-5	100-7137
10	0.900 [22.86]	1.000 [25.40]	250 ft	1-57746-0	100-7137
15	1.400 [35.56]	1.500 [38.10]	250 ft	1-57746-5	100-7137
20	1.900 [48.26]	2.000 [50.80]	250 ft	2-57746-0	100-7137
25	2.400 [60.96]	2.500 [63.50]	250 ft	2-57746-5	100-7137
28	2.700 [68.58]	2.800 [71.12]	250 ft	2-57746-8	100-7137
24 AWG 7/32 Overcoated Tin Plated Copper - 0.044 [1.12]					
5	0.400 [10.16]	0.500 [12.70]	250 ft	57747-5	100-7242
10	0.900 [22.86]	1.000 [25.40]	250 ft	1-57747-0	100-7242
15	1.400 [35.56]	1.500 [38.10]	250 ft	1-57747-5	100-7242
20	1.900 [48.26]	2.000 [50.80]	250 ft	2-57747-0	100-7242
25	2.400 [60.96]	2.500 [63.50]	250 ft	2-57747-5	100-7242
28	2.700 [68.58]	2.800 [71.12]	250 ft	2-57747-8	100-7242
22 AWG 7/30 Tin Plated Copper - 0.051 [1.30]					
5	0.400 [10.16]	0.500 [12.70]	250 ft	57748-5	100-7178
10	0.900 [22.86]	1.000 [25.40]	250 ft	1-57748-0	100-7178
15	1.400 [35.56]	1.500 [38.10]	250 ft	1-57748-5	100-7178
20	1.900 [48.26]	2.000 [50.80]	250 ft	2-57748-0	100-7178
25	2.400 [60.96]	2.500 [63.50]	250 ft	2-57748-5	100-7178
28	2.700 [68.58]	2.800 [71.12]	250 ft	2-57748-8	100-7178

0.156" [3.96mm] Centerline IDC Ribbon Cable, PVC Insulation

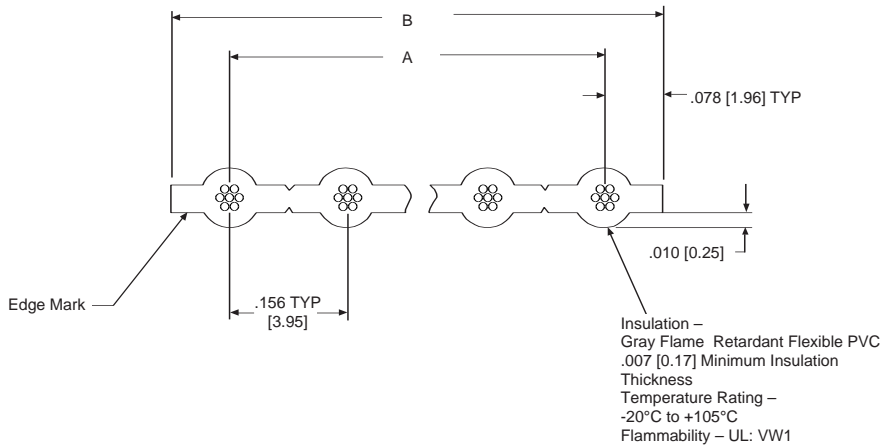

Product Specifications

- ▲ Voltage Rating: 300 Volts
- ▲ UL Recognized: AWM Style 2651
- ▲ CSA: AWM IA FTI

No. of Cond.	Dimensions		Roll Length	Part Part Number	Spec Number
	A	B			
22 AWG 7/30 Tin Plated Copper - 0.051 [1.30]					
2	0.156 [3.96]	0.312 [7.92]	250 Ft	57750-2	100-7234
5	0.624 [15.85]	0.780 [19.81]	250 Ft	57750-5	100-7234
10	1.404 [35.66]	1.560 [39.62]	250 Ft	1-57750-0	100-7234
15	2.184 [55.47]	2.340 [59.44]	250 Ft	1-57750-5	100-7234
20	2.964 [75.29]	3.120 [79.25]	250 Ft	2-57750-0	100-7234
24	3.588 [91.14]	3.744 [95.10]	250 Ft	2-57750-4	100-7234
18 AWG 7/26 Tin Plated Copper - 0.068 [1.73]					
2	0.156 [3.96]	0.312 [7.92]	250 Ft	57752-2	100-4394
5	0.624 [15.85]	0.780 [19.81]	250 Ft	57752-5	100-4394
10	1.404 [35.66]	1.560 [39.62]	250 Ft	1-57752-0	100-4394
13	1.872 [47.55]	2.028 [51.51]	250 Ft	1-57752-3	100-4394

Other Conductor Counts Available on Request

Standard Flat Ribbon Cables

Theory and Application

The proper selection and application of cables requires a knowledge of factors not involved in other types of cables. The following paragraphs have been prepared to aid in the selection of proper coax cable:

Signal Integrity and Propagation

To explain how to maintain signal integrity, it is necessary to review how the signal is configured in a cable and how it propagates. Ignoring digital signals for this discussion we will identify the issues that deal with the integrity of a sine wave. Consider a coaxial cable consisting of an inner conductor surrounded by a dielectric material and then an outer conductor (See Figure 1). The outer conductor may be a braid, a foil, or a solid metal.

An electromagnetic wave traveling in a coaxial cable produces an electric and a magnetic field between the inner conductor and the outer conductor (Figure 2).

The electric (E field) is radial and varies in time. An alternating current flows along the inner conductor and the outer conductor. An oscillating magnetic field (H field) circles the inner conductor.

The alternating current on a conductor is not spread throughout the conductor but is strongest at the surface and decays exponentially at points further into the conductor. This is called the **skin effect**. At a frequency of 1MHz, three skin depths is 0.0078" (95% of the current is within three skin depths of the surface) and at 10GHz three skin depths is 0.00078". As a result, the current is on the outer surface of the inner conductor and the inner surface of the outer conductor over the entire range of interest for most RF systems. The dimensions and material beyond several skin depths have no effect on the wave; gold plated plastic will propagate as well as gold plated copper at sufficiently high frequencies.

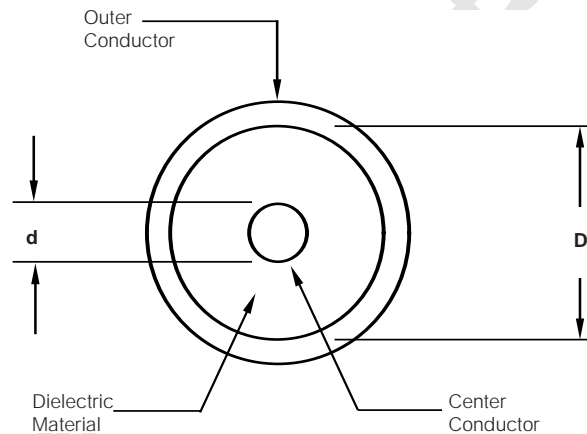

Figure 1

Diagram of a Cable

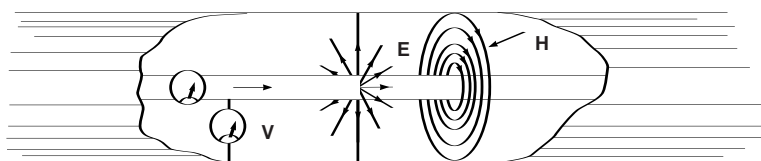

Figure 2

Electric field (E) and magnetic field (H) belonging to the principal mode in a coaxial line.

Technical Information

Velocity of Propagation

When an electromagnetic wave travels in a medium other than air or vacuum, the **velocity** for the wave is reduced by a factor of the square root of the dielectric constant (ϵ) of the media. The velocity (v) of the propagation of a signal is given by:

$$v = \sqrt{\frac{c}{\epsilon}}$$

Where c is the speed of light, 3×10^8 m/sec or 1.18×10^{10} in/sec, and ϵ is the dielectric constant of the medium. (See Table 1 for dielectric constants of various materials)

The **wavelength** of a signal is given by the formula

$$\lambda = v/f = \frac{c}{\sqrt{\epsilon} \times f} = \frac{1.18 \times 10^{10}}{\sqrt{\epsilon} \times f \text{ (GHz)}} \text{ inches}$$

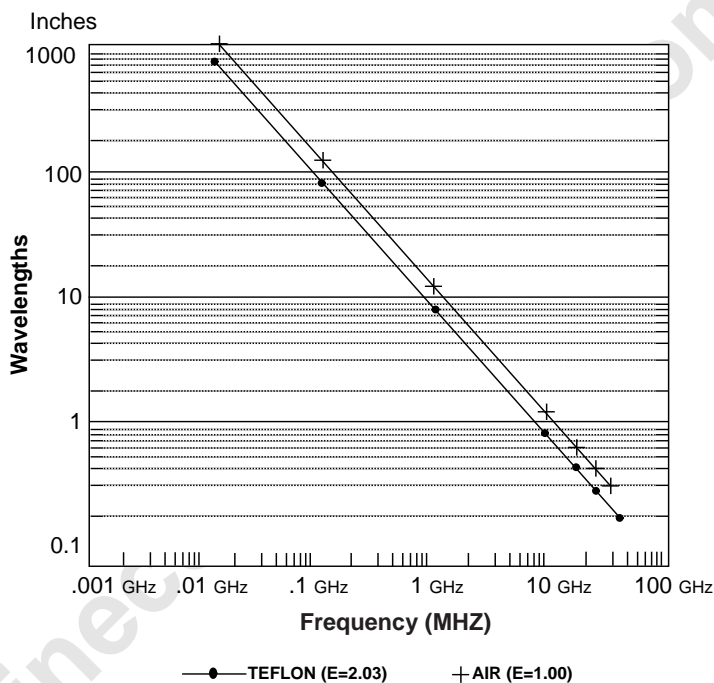

Figure 3

Table 1.
Properties of Insulating Materials

Dielectric Material	Dielectric Constant	Operating Temperature Range
TFE	2.03	-70 +250°C
Polyethylene	2.3	-60 +80°C
Nylon	4.6-4.0	-40 +120°C
Polypropylene	2.25	-40 +105°C

Attenuation

A wave loses energy (attenuates) in several ways: (1) The resistance of the inner and outer conductors is small but can be significant over long lengths and will produce some heat. (2) The dielectric may cause loss; its resistance is high but not infinite, and some energy is lost. (3) Electromagnetic energy radiates at high frequencies; significant energy losses are caused by radiation of electromagnetic energy (the cable acts like an antenna). (4) Energy is reflected due to impedance mismatches or impedance discontinuities. The combination of these four types of losses are referred to as the **insertion loss** of a transmission line system.

Characteristic Impedance

A parameter which defines the behavior of a cable, connector, or any propagating system is **Characteristic Impedance**, Z_0 . The characteristic impedance of a lossless cable is related to the inductance per unit length, L , and the capacitance per unit length, C , as follows:

$$Z_0 = \sqrt{L/C} \text{ in ohms}$$

The equivalent circuit of a transmission line is shown in Figure 4. R represents the conductor resistance for a unit length.

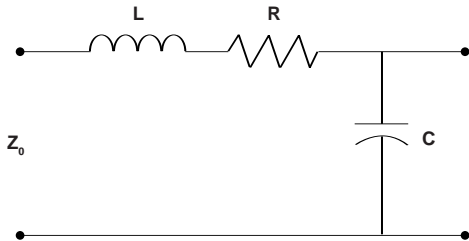

Figure 4

Typical Transmission Line Schematic

For a coaxial cable the characteristic impedance is given by:

$$Z_0 = \frac{138}{\sqrt{\epsilon}} \times \log_{10} \frac{D}{d} \text{ in ohms}$$

where "D" is the inner diameter of the outer conductor and "d" is the outer diameter of the inner conductor, respectively. Similar equations apply for other geometries such as two parallel wires.

As can be observed from this equation, the impedance is a function of the diameters. Generally the conductor diameter can be very accurately controlled, but the dielectric diameter can vary based on the accuracy of the process. If the impedance changes are a consistent spacing of one 1/4 wavelength, this can cause significant signal loss.

Reflections

When the characteristic impedance changes in a transmission line system, part of an incident wave is reflected. The reflection coefficient can be calculated as:

$$\text{Reflection Coefficient} = \rho = \frac{V_i}{V_R} = \frac{Z_R - Z_0}{Z_R + Z_0}$$

Where V_i and Z_0 are the incident voltage and impedance of the first media. V_R and Z_R represent the reflected voltage and impedance of the media that caused the reflection. The decibel loss due to reflection is given by:

$$\text{Return Loss} = 10 \log_{10} \left(\frac{1}{1 - \rho^2} \right) \text{ dB}$$

VSWR

The traditional way to determine the reflection coefficient is to measure the standing wave caused by the superposition of the incident wave and the reflected wave. Traditionally the voltage is measured at a series of points using a slotted line. The ratio of the maximum divided by the minimum is the Voltage Standing Wave Ratio (VSWR). The VSWR is infinite for total reflections because the minimum voltage is zero. If no reflection occurs the VSWR is 1.0. VSWR and reflection coefficient are related as follows:

$$\text{VSWR} = (1 + \rho)/(1 - \rho)$$

Present instrumentation measures the return loss.

Figure 5 represents the relationship between VSWR and its equivalent in return loss (expressed in dB).

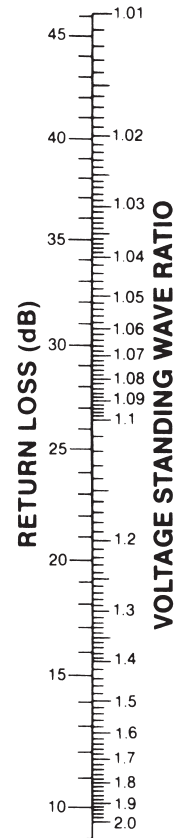

Figure 5

VSWR vs. Return Loss

Multiple Reflections

If there is a series of impedance changes, each one will cause a reflection. The total reflection is the vector addition of each of the individual coefficients accounting for the distance between discontinuities. Even though the calculations are difficult, a total VSWR can still be measured.

Conductor - Materials/Construction:

Conductor Material:

The ability of a material to act as a conductor, semi-conductor or insulator is determined by that material's molecular structure.

Copper

Copper is by far the most versatile and the most widely used conductor material. It is also compatible with numerous coatings to enhance termination and retard corrosion. Annealed copper conductors provide better flex life than hard copper conductors.

Copper Clad Steel

Copper covered steel is utilized when greater strength than that of solid copper conductor is required and where some of the conductivity of solid copper can be sacrificed. Copper clad steel consists of a steel core with a concentric copper covering thoroughly bonded to it. The most widely used grades are:

High Strength - 40% Conductivity

High Strength - 30% Conductivity.

The above conductivity is expressed in terms of conductivity of a solid copper wire of equal diameter. Where greater flexibility is necessary, the annealed grade should be specified since it employs a soft steel core with the flexibility near that of copper but with twice the strength. High strength will be achieved by using the hard drawn form. In the applications of high frequency transmission, no loss of conductivity is evident from that of solid copper due to transmission along the copper surface (skin effect). However, at power frequencies, the conductivity is 30 or 40% that of copper wire.

High Strength Alloys

Greater breaking strength and flex life are achieved by alloying copper with cadmium chromium, cadmium, chromium and zirconium. With only a slight increase in resistivity compared with copper clad steel, these alloys allow size and weight reduction to be achieved in electronic and aerospace applications.

Cadmium Chromium copper provides the highest conductivity of the above four alloys and is suitable for high temperature application.

Copper Conductors:

Resistivity

All conductor materials possess resistance to pass electrical energy.

Ampacity

Ampacity (or current carrying capacity) is determined by a number of factors:

1. The maximum continuous thermal performance of the covering insulation,
2. By the heat generated in the cable (result of conductor and insulation losses) and
3. By the heat-dissipating properties of the cable and its environment.

Heat generated in a conductor varies as the square of the applied current. The factors influencing current carrying capacity are:

- * Conductivity of Conductor Material - The higher conductivity materials such as silver and copper possess higher current carrying capacity compared with alloys or aluminum hence generating less heat.
- * Conductor Size- Ampacity varies directly with conductor size and will increase as the diameter increases.
- * Insulation Material - The specific heat of the insulating material will determine its ability to conduct heat through the wall to the surrounding medium (air, water, etc.) In no case should the conductor temperature exceed the thermal rating of the insulation.
- * Surrounding Temperature - Ambient conditions such as a higher air temperature will reduce heat transfer away from the conductor.

Stranding

Stranded conductor constructions were developed as a means of overcoming the rigidity of solid wires. For any given wire size, the greater the number of strands with corresponding decrease in individual strand size, the more flexible and costly the conductor.

An increase in diameter must be associated with the use of stranded wires; resistance and weight are affected as well, depending on the number of strands and lay length used.

There are specific numbers of strands which lend themselves to round configurations, i.e., 7, 12, 19, 27 and 37. Normally beyond 37 strands, rope type constructions are utilized consisting of 7 or 19 strand groups.

Property	Annealed Copper	Copper Clad Steel (40% Conductivity)	High Strength Alloy 135
Density (gm/cm3)	8.89	8.15	8.71
Resistivity (ohm-cm/ft)	10.37	26.45	11.30
Tensile Strength (psi)	35,000	110,000	60,000
Coating Available*	T S N	S	S N
Maximum Service Temp (°C)	150 200 260	200	200 200

*T-Tin S-Silver N-Nickel



Electronics

Cable Design (Continued)

Table 2 Conductor Data (Solid Copper)

AWG	Diameter			Cross Section Area		Weight		DCR @ 20°C Tinned Copper		DCR @ 20° Bare Copper		Break Strength	
	inches	mils	mm	circ. mils	sq. mm	lbs/Kft	Kg/Km	ohms/Kft	ohms/Km	ohms/Kft	ohms/Km	lbs. (max.)	Kg (max.)
36	0.0050	5.0	0.127	25.0	0.0127	0.0757	0.113	441	1447	415	1360	0.78	0.36
35	0.0056	5.6	0.142	31.4	0.0159	0.0949	0.141	350	1148	331	1080	0.99	0.45
34	0.0063	6.3	0.160	39.7	0.0201	0.1200	0.179	274	890	261	857	1.25	0.57
33	0.0071	7.1	0.180	50.4	0.0255	0.1530	0.228	215	705	206	675	1.57	0.71
32	0.0080	8.0	0.203	64.0	0.0324	0.1940	0.289	169	554	162	532	1.98	0.90
31	0.0089	8.9	0.226	79.2	0.0401	0.2400	0.357	136	446	131	430	2.50	1.14
30	0.0100	10.0	0.254	100	0.0507	0.3030	0.451	107	351	104	340	3.16	1.43
29	0.0113	11.3	0.287	128	0.0649	0.3870	0.576	83.9	275	81.2	266	3.98	1.81
28	0.0126	12.6	0.320	159	0.0806	0.4810	0.716	67.5	221	65.3	214	5.02	2.27
27	0.0142	14.2	0.361	202	0.1020	0.6100	0.908	53.1	174	51.4	169	6.33	2.87
26	0.0159	15.9	0.404	253	0.1280	0.7650	1.140	42.4	139	41.0	135	7.98	3.62
25	0.0179	17.9	0.455	320	0.1620	0.9700	1.440	33.4	109	32.4	106	10.07	4.55
24	0.0201	20.1	0.511	404	0.2050	1.2200	1.820	26.5	86.9	25.7	84.2	12.69	5.76
23	0.0226	22.6	0.574	511	0.2590	1.5500	2.310	20.9	68.6	20.3	66.6	15.41	6.99
22	0.0253	25.3	0.643	640	0.3240	1.9400	2.890	16.7	54.8	16.2	53.2	19.43	8.81
21	0.0285	28.5	0.724	812	0.4110	2.4600	3.660	13.1	42.9	12.8	41.9	24.50	11.11
20	0.0320	32.0	0.813	1020	0.5190	3.1000	4.610	10.5	34.4	10.1	33.2	30.89	14.01
19	0.0359	35.9	0.912	1290	0.6530	3.9000	5.800	8.31	27.3	8.05	26.4	38.95	17.67
18	0.0403	40.3	1.020	1620	0.8230	4.9200	7.320	6.59	21.6	6.39	21.0	49.12	22.28
17	0.0453	45.3	1.150	2050	1.0400	6.2300	9.240	5.22	17.1	5.05	16.6	61.93	28.09
16	0.0508	50.8	1.290	2580	1.3100	7.8100	11.600	4.15	13.6	4.02	13.2	78.10	35.43
15	0.0571	57.1	1.450	3260	1.6500	9.8700	14.700	3.29	10.8	3.18	10.4	98.48	44.67
14	0.0641	64.1	1.630	4110	2.0800	12.4000	18.500	2.61	8.56	2.52	8.28	124.2	56.34
13	0.0720	72.0	1.830	5180	2.6300	15.7000	23.400	2.07	6.79	2.00	6.56	156.6	71.03
12	0.0808	80.8	2.050	6530	3.3100	19.8000	29.500	1.64	5.38	1.59	5.21	197.5	89.58
11	0.0907	90.7	2.300	8230	4.1700	24.9000	37.100	1.30	4.27	1.26	4.14	249.0	112.9
10	0.1019	101.9	2.590	10380	5.2600	31.4000	46.800	1.03	3.38	0.99	3.28	314.0	142.4

Table 3 Conductor Data (Stranded Copper)

AWG	Stranding	Diameter		Cross-Section Area		Weight		DCR @ 20°C Tinned Copper		DCR @ 20°C Bare Copper	
		inches	mm	circ. mils	sq. mm	lbs/Kft	Kg/Km	ohms/Kft	ohms/km	ohms/Kft	ohms/km
32	7/40	0.0093	0.236	67	0.0434	0.203	0.302	171.0	561.0	165.7	543.6
30	7/38	0.0117	0.297	112	0.0723	0.339	0.504	100.6	330.1	98.0	321.5
30	19/42	0.0120	0.305	119	0.0766	0.366	0.546	98.0	321.5	94.9	311.4
29	7/37	0.0135	0.343	142	0.0915	0.429	0.638	78.7	258.2	76.6	251.3
28	7/36	0.0147	0.373	175	0.113	0.529	0.788	64.1	210.3	62.2	204.1
28	19/40	0.0147	0.373	183	0.118	0.563	0.839	63.6	208.7	61.7	202.4
27	7/35	0.0170	0.432	220	0.142	0.664	0.989	51.2	170.0	50.1	164.4
26	7/34	0.0190	0.483	278	0.179	0.840	1.25	39.8	130.6	38.8	127.3
26	10/36	0.0190	0.483	250	0.163	0.756	1.13	44.2	145.0	43.3	142.1
26	19/38	0.0190	0.483	304	0.196	0.956	1.42	36.9	121.1	36.0	118.1
26	26/40	0.0180	0.457	250	0.161	1.03	1.15	46.0	150.9	44.4	145.7
25	7/33	0.0210	0.533	353	0.228	1.07	1.59	31.2	102.4	30.7	100.7
24	7/32	0.0240	0.610	448	0.289	1.36	2.01	24.3	79.7	24.0	78.7
24	10/34	0.0220	0.559	397	0.256	1.20	1.79	27.8	91.2	27.1	88.9
24	16/36	0.0220	0.559	400	0.258	1.21	1.80	27.9	91.5	27.1	88.9
24	19/36	0.0240	0.610	475	0.306	1.47	2.18	23.4	76.8	23.2	76.1
24	41/140	0.0220	0.559	394	0.254	1.23	1.83	29.5	96.8	28.2	92.5

Technical Information



Electronics

Cable Design (Continued)

Table 3 Conductor Data (Stranded Copper) (continued)

AWG	Stranding	Diameter		Cross-Section Area		Weight		DCR @ 20°C Tinned Copper		DCR @ 20°C Bare Copper	
		inches	mm	circ. mils	sq. mm	lbs/Kft	Kg/Km	ohms/Kft	ohms/km	ohms/Kft	ohms/km
22	7/30	0.0300	0.762	700	0.452	2.11	3.15	15.4	50.5	15.4	50.5
22	16/34	0.0280	0.711	635	0.410	1.92	2.86	17.3	56.8	17.1	56.1
22	19/34	0.0300	0.762	754	0.487	2.32	3.46	14.9	48.9	14.3	46.9
22	26/36	0.0290	0.737	650	0.419	2.10	2.99	17.3	56.8	16.8	55.1
22	27/36	0.0290	0.737	675	0.435	2.08	3.1	16.8	55.1	16.1	52.8
22	66/40	0.0280	0.711	634	0.409	1.99	2.97	18.6	61.0	18.1	59.4
21	19/33	0.0345	0.876	958	0.618	2.96	4.4	11.6	38.1	11.3	37.1
20	7/28	0.0380	0.965	1111	0.717	3.36	5.01	9.8	32.2	9.6	31.5
20	10/30	0.0360	0.914	1000	0.645	3.02	4.5	10.8	35.4	10.9	35.8
20	19/32	0.0380	0.965	1216	0.785	3.75	5.59	9.2	30.2	8.9	29.1
20	26/34	0.0360	0.914	1032	0.666	3.20	4.77	10.7	35.1	10.5	34.4
20	41/36	0.0360	0.914	1025	0.661	3.19	4.76	11.0	36.1	10.8	35.4
20	42/36	0.0360	0.914	1050	0.677	3.27	4.87	10.8	35.4	10.4	34.1
20	7x38/44	0.0400	1.02	1064	0.686	3.35	4.98	11.2	36.7	11.1	36.4
19	24/32	0.0420	1.07	1536	0.991	4.77	7.1	7.1	23.3	7.0	22.9
18	7/0.0152	0.0455	1.16	1617	1.04	4.89	7.28	6.7	21.9	6.7	21.9
18	7/26	0.0480	1.154	1770	1.14	5.35	7.97	6.2	20.3	6.1	20.0
18	16/30	0.0450	1.143	1600	1.03	4.84	7.21	6.8	22.3	6.7	21.9
18	19/30	0.0480	1.219	1900	1.22	5.86	8.73	5.8	19.0	5.7	18.7
18	41/34	0.0440	1.118	1627	1.05	5.07	7.55	6.9	22.6	6.7	21.9
18	65/36	0.0440	1.118	1625	1.05	5.11	7.61	6.8	22.3	6.8	22.3
18	7x59/44	0.0530	1.346	1652	1.07	5.20	7.74	7.3	23.9	7.0	22.9
16	7/24	0.0600	1.524	2828	1.82	8.55	12.7	3.9	12.8	3.8	12.5
16	7/0.0192	0.0570	1.448	2580	1.66	7.81	11.6	4.3	14.1	4.2	13.8
16	19/29	0.0540	1.372	2426	1.57	7.49	11.1	4.5	14.8	4.4	14.4
16	19/0.0117	0.0560	1.422	2601	1.68	8.02	11.9	4.2	13.8	4.2	13.8
16	26/30	0.0570	1.448	2600	1.68	8.07	12.0	4.3	14.1	4.2	13.8
16	65/34	0.0570	1.448	2580	1.66	8.12	12.1	4.3	14.1	4.3	14.1
16	105/36	0.0570	1.448	2625	1.69	8.26	12.3	4.3	14.1	4.2	13.8
14	7/0.0242	0.0725	1.842	4099	2.64	12.4	18.5	2.7	8.86	2.7	8.86
14	7/22	0.0760	1.930	4481	2.89	13.6	20.2	2.5	8.20	2.6	8.53
14	19/27	0.0675	1.715	3831	2.47	12.1	17.9	2.8	9.19	2.6	8.53
14	19/0.0147	0.0710	1.803	4106	2.65	12.9	19.2	2.7	8.86	2.7	8.86
14	41/30	0.0700	1.778	4100	2.65	12.8	19.0	2.7	8.86	2.7	8.86
12	7/0.0305	0.0920	2.337	6512	4.20	19.7	29.3	1.7	5.58	1.7	5.58
12	19/25	0.0850	2.159	6088	3.93	18.8	28.0	1.8	5.91	1.8	5.91
12	19/0.0185	0.0880	2.235	6502	4.19	20.1	29.9	1.7	5.58	1.7	5.58
12	65/30	0.0890	2.261	6500	4.19	20.4	30.4	1.7	5.58	1.7	5.58
12	7x24/34	0.1000	2.540	6668	4.30	21.0	31.2	1.7	5.58	1.7	5.58
10	19/0.0234	0.1120	2.845	10404	6.71	32.1	47.8	1.1	3.61	1.1	3.61
10	37/26	0.1080	2.743	9354	6.03	29.0	43.2	1.2	3.94	1.2	3.94
10	105/30	0.1150	2.921	10500	6.77	33.0	49.2	1.1	3.61	1.0	3.28
8	19/0.0295	0.1380	3.505	16535	10.7	51.0	75.9	0.66	2.17	0.66	2.17
8	7x19/29	0.1600	4.064	16983	11.0	53.4	79.5	0.65	2.13	0.65	2.13
8	7x24/30	0.1620	4.115	16800	10.8	52.8	78.7	0.65	2.13	0.65	2.13
6	7x19/27	0.1990	5.055	26818	17.3	84.4	125.6	0.41	1.35	0.41	1.35
4	7x19/25	0.2500	6.350	42615	27.5	134.1	199.6	0.39	1.28	0.39	1.28
4	7x60/30	0.2520	6.400	42000	27.1	132.1	196.7	0.26	0.853	0.26	0.85

Technical Information

Strand Construction

Bunched - Conductor strands of any number twisted together in the same direction without regard to the geometric arrangement.

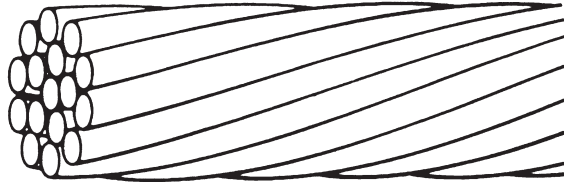

Bunch Stranding

True Concentric - A central wire surrounded by layers of helically laid wires. Each layer has reversed lay direction and an increasing lay length in each succeeding layer. The inner layer will support the outer layers to prevent migration of strand that can occur in bunch constructions.

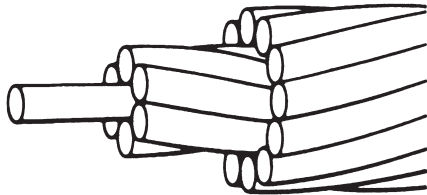

True Concentric and Equilay Stranding

Unidirectional Concentric - A central wire surrounded by one or more layers of helically laid wires with same direction of lay and increasing lay length in each succeeding layer. It has an advantage of much greater flexibility and flex life than true concentric.

Unilay - A multi-layer of helically laid wires with the same direction and same lay length for each layer.

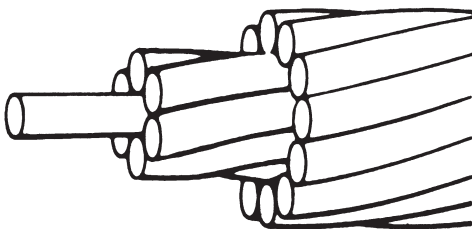

Unidirectional Concentric and Unilay Stranding

Equilay - Composed of multi-layers of helically laid wire, with the direction of lay reversed for succeeding layers. As the name designates, all layers have equal lay length.

Rope - Is cabled groups of any of the above stranded members. It is standard to use a number of groups that provide a round construction (7, 13, 19, 27). Rope lay is basically used for large gauge (No. 10 AWG and larger) constructions that consist of a central core stranded member surrounded by one or more layers of stranded members.

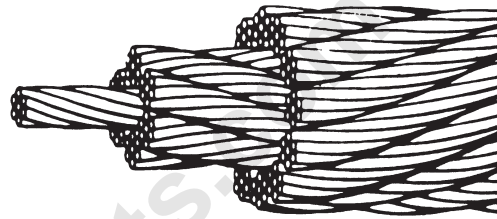

Rope Stranding

Conductor Coatings

Bare copper conductor will oxidize from exposure to the atmosphere forming copper oxide on the surface. Oxidation and other types of corrosion are accelerated by the presence of heat, moisture, and some insulating materials such as rubber. The oxide film is a poor conducting material and must be removed to assure a good, reliable terminal connection. To prevent corrosion and enhance terminating (soldering), bare copper is coated with a metal that is not susceptible to oxidation and corrosion. Contact resistance between conductors and terminals is reduced with coating materials like tin, silver and nickel.

Tin is the most frequently used coating; however, nickel and silver are used for specific applications.

Tin - The least expensive coating for ordinary usage is tin. It is a soldering aid and is specified when that type of terminating method is used.

Tinned Copper - Normally a film thickness of 20 micro-inches (.000020") is applied to each strand. The strands are twisted together to form the tinned copper conductor.

Heavy Tinned Copper - Carries a heavier tin thickness on the individual strand - 100 micro-inches on smaller than 30 AWG strands; 150 micro-inches on 30 AWG and larger.

Prefused Copper - Consists of twisted strands of heavy tinned copper fused with heat along the length.

Overcoated Copper - Consists of tinned strands of copper twisted together followed by a tin coating over the twisted conductor. The finished product is bonded along its entire length.

Topcoated Copper - Consists of bare copper strands twisted together, with the resulting conductor given a coating of tin. The finished product is bonded along its entire length.

Silver - Silver is primarily electroplated to copper and then drawn down to the proper conductor size with a resulting 40 micro-inch coating. Silver-coated conductors are reliable for continuous temperature application through 200°C. Although higher in cost than tinned copper, silver coated conductors have a lower resistance, than either tin or nickel coated conductors. At higher frequencies, the current density is at the conductor surface (skin effect) thereby making this highly conductive coating material the most effective of all coatings.

Nickel - Nickel plating is considered suitable for continuous service up to 260°C. At these elevated temperatures, nickel does not tarnish as does silver.

Insulation/Jacket

Introduction:

Based on the requirements the best insulating material for the application will be selected. The selection may involve examination of many different performance properties. The properties are addressed in the following sections and tables.

General Terms:

Thermoplastic: Materials that soften and flow when heated. Usually possess a definite melting point. The material will become firm again upon cooling. These materials can be molded and shaped with a heating and cooling process. (This process can be repeated.) Extrusion of melt flow polymers on wire is an example of this type of material.

Thermoset: Materials are soft and pliable during one stage of processing, can be molded and extruded at this state after which they are set or cured, usually at a higher temperature. After the setting process (cross linking) is complete they cannot be softened by reheating, hence heat and solvent resistance properties are improved over thermoplastic materials.

Insulation: Materials possessing good dielectric properties used on wire components in cable usually as direct covering on conductors.

Jacket: Materials that provide a protection in mechanical and chemical properties applied as a direct covering over cable components. The choice of materials for cable design to satisfy any given combination of installation and environmental conditions can often be more critical than the electrical requirements.

Insulation and Jacket Compound Properties*

Material	Max Operating Temp °C	Dielectric K @ 1Mhz	Specific Gravity	Oxygen Index
Vinyl (PVC)				
Plasticized (Conventional)	105	4-6	1.38	26-30
Semi Rigid	80	4.0	1.39	36
Irradiated	105	2.70	1.38	27
Polyethylene				
Low Density	80	2.28	0.92	18
High Density	80	2.34	0.95	18
Flame Retardant	80	2.35	1.0	27
Cellular (Foam)	80	1.55 ¹	0.50 ¹	18
Cross-Linked	90	2.44	1.19	27
Polypropylene				
Solid	90	2.30	0.91	18
Cellular (Foam)	90	1.50 ¹	0.50 ¹	18
Thermoplastic Elastomer	105	2.80	1.20	32
Teflon® FEP				
Solid	200	2.1	2.15	95
Cellular (Foam)	200	1.4 ¹	1.1 ¹	40
Teflon® PFA	250	2.1	2.15	30
Tefzel® ETFE	150	2.6	1.7	30
Kynar® PVDF	135	6.4	1.76	44
Halar® ECTFE	150	2.56	1.7	30
Nylon	105	4-8	1.13	22
Mylar (Polyester)	150	3.0	1.40	20
Polyurethane	80	—	1.13	20-29
Solef® PVDF	150	—	1.78	40

* Nominal Values

¹ Properties based on expansion level

General Properties of Insulation Compounds

The primary insulation material is the most important of the cable materials for overall performance reasons.

- ▲ Voltage dielectric for higher voltage charge at the conductor surface.
- ▲ Low loss material for higher frequency signal cables.
- ▲ Heat resistance in high temperature environments.
- ▲ Low temperature flexibility.
- ▲ Toughness for cut-through, abrasion and crush resistance.

Insulation compounds serve an electrical function first. Secondary properties consider the environmental factors.

Polyvinyl Chloride (PVC): This material is available in many formulations tailored to meet specific needs. Madison provides two (2) basic types:

Plasticized flexible materials for 80°, 90°, and 105°C applications.

Semi-rigid compounds rated at 80°C that can be made as thin wall products (8-9 mils).

PVC compounds are moderately good dielectric materials. Depending on the formulation, the dielectric constant can vary from 3 to 6. Formulations typically include the PVC resin, plasticizer, stabilizer, flame retardants, fillers, and specialty additives.

PVC compounds are limited to 105°C temperature applications and a cold environment of -40°C. Plasticizers can migrate from the compound causing the material to become brittle, especially at lower temperatures.

Typical Properties of Madison PVC Insulations

Property	Flexible*	Semi-Rigid
Physical		
Specific Gravity	1.30-1.40	1.5
Durometer (Hardness)	90 Shore A	63 Shore D
Tensile Strength (psi)	1500	3500
Elongation (%)	150-300	200
Max. Opr. Temperature (°C)	60-105	80
Oxygen Index	25-30	30
Solder Iron Resistance	Poor	Poor to Fair
Cut-through	Poor to Fair	Good
Electrical		
Dielectric Constant	4-6	3.0-3.5
Volume Resistivity (Ω-cm)	10 ¹¹ -10 ¹²	10 ¹⁴
Dielectric Strength (Volts/Mil)	300-600	700
Insulation Resistance (Megohm - 1000 ft.)	500-2000	5000

* Properties vary depending on compound design.

Polyolefins

Polyolefins are made up of a family of hydrocarbons similar in nature to paraffin oils and waxes. Over the past few decades they have been the most common of insulation materials because of a number of superior characteristics, low cost and availability.

Polyethylene: It is specified by general classifications of density (low, medium, and high). Combined high performance of electrical and physical properties have made this versatile polymer widely accepted.

Electrical performance of polyethylene is excellent. Dielectric quality is known by a high dielectric strength (volts per mil), low dielectric constant, low dissipation factor and high insulation resistance. These properties are stable over a broad range of frequencies and temperature.

Physical properties of polyethylene are generally considered good except for fire resistance and ultra-violet resistance (weatherability). Modifiers are used to tailor specific improvements in these areas.

Polypropylene: This polyolefin material is characteristic in many ways to high density polyethylene; electrical and chemical resistance are similar. It has superior physical properties such as abrasion, cut through, and heat resistance; however, it has a lower density. It is flammable, but flame retardant grades can be made available. It is preferred to polyethylene for stress crack resistance applications. Much of polypropylene is used in telecommunication cables for physical and dielectric quality.

Cellular Polyolefin: Dielectric improvements in capacitance within insulations are provided by production of a cellular

structure in the finished insulation. Processes of producing an inert gas in the polymer melt are controlled in the extruder and the resulting extrudate can be provided with a variation in the amount of voids (air to solid regions). This allows control over the dielectric constant and dissipation factor. Polyolefin dielectric constant (typically 2.27) can be lowered to 1.55 by expansion.

Flame Retardant Polyethylene: Compounds of polyethylene employing fire retardant additives are available, but there is some sacrificing of properties to consider when designing these materials into electrical wire applications.

Typical Properties of Madison Polyolefin Insulations

Property	Low Density	High Density	Flame Retardant	Polypropylene	Cellular (1)
Physical					
Density	.92	.95	1.0	.90	.45-.80
Tensile Strength (psi)	2000	3000	2000	3000	600-1000
Elongation (%)	300	500	300	500	100-200
Max. Opr. Temp (°C)	80	80	80	80	80
Low Temp. Brittleness (°C)	-65	-76	-20	-40	-65
Solder Iron	Poor	Poor	Poor	Poor	Poor
Abrasion Resistance	Good	Good	Fair	Good	Poor
Flame Resistance	Poor	Poor	Good	Poor	Poor
Electrical					
Dielectric Constant	2.28	2.34	2.35	2.27	1.45-1.75
Dissipation Factor	.0002	.0001	.001	.0003	.0002
Insulation Resistance (Megohm-1000 ft.)	20000	20000	10000	20000	1000
Dielectric Strength (Volts/Mil)	800	1000	800	1000	200-500

(1)-properties vary with amount of expansion

Non Halogen Compounds:

Over the past few years, non halogen, flame retardant, reduced emissions compounds have been developed in response to a growing demand for products which offer greater protection against fatalities, injuries and property damage from fire. When burned, cables made with non-halogen flame retardant compounds give off as little as one-quarter the smoke and fumes of conventional cable materials. These compounds have good crush and deformation resistance, good flexibility, excellent long term aging properties plus physical integrity at low temperatures.

Fluorocarbons

There are a number of fluorocarbon resins available as insulating materials. Each fluorocarbon type is distinctly different, however they all can be classified as highly fire resistant and physically and electrically stable at elevated temperature.

FEP: FEP has a service temperature of 200°C with excellent electrical properties - dielectric constant (2.1) and dissipation factor (.001) that is consistent through its maximum operating temperature and frequency range.

Low temperature properties of FEP are similar to those of TFE resulting in a -65°C rating. FEP insulated wire can be supplied in long continuous lengths allowing it to service a wider range of applications. FEP cannot be used in applications where thermosetting quantities are required (solder iron or short term overload). Along with the inherent flame resistance, this material is widely used in plenum cable applications because it produces low smoke in fire events.

PFA: PFA has a 260°C temperature rating, therefore it is an excellent choice for wiring requiring TFE properties and long lengths.

ETFE (Tefzel®): For application where properties of FEP are needed, with better chemical resistance.

ECTFE (Halar®): This material is slightly different from ETFE in chemical resistance, cross-linking ability, electrical, physical and thermal properties.

Like FEP and TFE, ECTFE is not useful where corona conditions prevail as in high voltage applications. As with other resins, irradiation cross-linking improves stress crack resistance. ECTFE ranks among the most radiation resistant polymers comparing with ETFE and polyethylene in this property.

PVDF (Kynar®): This material is rated for continuous use over a temperature range of -65° to 125°C. It has good resistance to corrosive chemical and organic solvents. Although this material is very hard with high tensile strength, abrasion resistance and excellent cut-through, limitations of flexibility are evident. It is resistant to creep and fatigue. It can be used in exterior applications because it is stable in sunlight and other sources of UV radiation.

Typical Properties of Madison Fluorocarbon Insulations

Type Property	FEP	PFA	ETFE Trade Name TEFZEL®	ECTFE Trade Name HALAR®	PVDF Trade Name KYNAR®	PVDF Trade name SOLEF®	Foam TEFLON® FLUOROCARBON
Specific Gravity	2.15	2.15	1.70	1.68	1.76	1.75	1.10-1.40
Tensile Strength (psi)	2500	2500	6500	4500	4500	4500	700-1400
Elongation (%)	250	250	150	150	150	150	100-150
Hardness	D55	D60	D75	D75	D75	D75	—
Temperature Rating (°C)	200	260	150	150	125	150	200
Low Temperature (°C)	-65	-65	-65	-75	-65	-35	-65
Flame Resistance (VW-1)	Pass	Pass	Pass	Pass	Pass	Pass	Pass
Dielectric Constant	2.1	2.1	2.6	2.6	9.7	9.6	1.3-1.7
Dissipation Factor	.001	.002	.005	.003	.019	—	.0003
Volume Resistivity (Ω-cm)	>10 ¹⁸	>10 ¹⁸	>10 ¹⁶	>10 ¹⁵	>10 ⁷	>10 ¹⁴	—
Applications	Coaxial Cable Plenum Cable Heater Cable Computer Cable	High Temp Wire Heater Wire Geophysical Fiber Optic Jacket	Nuclear Control Cable Aircraft Wire Computer Back Panel Rapid Transit	Nuclear Control Cable Oil-well Insul. Computer Wire Rapid Transit	Computer Back Panel Plenum Jacket Cathodic Protection Cable	Plenum Jacket	Data Transmission Plenum Coax

TEFZEL and TEFLON are trademarks of E. I. du Pont de Nemours & Company

Technical Information



Electronics

Cable Design (Continued)

Electrical properties of PVDF are not as good as other fluoropolymers. Most common use of this material is for jackets and back panel wire where electrical performance is not critical. PVDF is highly flame resistant and low smoke producing finding wide use as plenum cable jackets.

Foam Fluorocarbons: To further improve on the superb properties of Teflon® FEP, processes have been developed to foam the FEP, resulting in lower dielectric material. These materials are increasingly used in plenum applications. They produce little smoke and minimize dripping and fire propagation.

Jacket Compounds

Jacket or sheaths over multicomponent cable or single components act as a protective covering as well as contain the component elements and shields. Jackets can be made semiconductive, depending on the application. Jacket materials are called upon to be flame resistant, physically tough, flexible, chemically resistant and to have a good appearance.

Types

PVC: Is the most widely used non-plenum jacket. A variety of compounds are available to serve a wide range of applications. Fire safety is an important role served by PVC jackets.

Polyurethane: A material used for severe service of abrasion and cut-through with flexibility. A range of grades are available to meet various applications, such as extreme low temperatures.

Polyethylene: Inherent properties make it ideal for direct burial applications.

Thermoplastic Elastomer (TPE): A suitable replacement to rubber where the thermosetting properties of rubber are not critical.

Fluorocarbon: Physical toughness and fire resistant characteristics override the slight increase in cost. See description of benefits in the section on dielectric material.

Typical Properties of Madison Jacket Compounds

Property	TPE Thermoplastic Elastomer	Nylon Polyamide	PU Polyurethane	PVC Polyvinyl Chloride*	PE Polyethylene	Fluorocarbon**	Non-Halogen	PVC Alloy
Tensile Strength (psi)	1700	6500	5000	1500-3000	3000	3500	1200-2000	2500
Elongation (%)	450	250	500	200	500	150	150-200	200
Operating Temperature								
High (°C)	125	105	80	80-105	80	125	90	75
Low (°C)	-50	-40	-50	-25	-40	-40	-40	0
Oil Aging ASTM No. 2 (Days/°C)	7/60	—	30/15.6	7/60	—	—	—	—
Tear Strength Die C (lb./in.)	380	—	290	—	450	—	—	—
Specific Gravity	1.20	1.13	1.20	1.25-1.40	0.93	1.76	1.3-1.6	1.6
Shore Hardness	A95	D85	A82	A70-A95	D45	D65	A80 - A95	C83
Fire Resistance-Oxygen Index	30*	23	30*	25-35	18	44	35-48	47
Dielectric Strength (Volts/mil)	500	450	400	450	500	500	500	500
Volume Resistivity (Ω-cm)	2 x 10 ¹⁶	10 ¹²	2 x 10 ¹¹	10 ¹⁴	2 x 10 ¹⁶	10 ¹⁴	10 ¹²	10 ¹²
Applications	-Appliance Wire -Coiled Cord -Arctic	-THHN/THWN -Jackets for Small Cables -Industrial Control Cable	-Camera Cable -Military Cable -Fiber Optics -coil cord	-Computer Cable -Coaxial Cable	-Direct Burial -Control Cable	-Plenum Cable -Control Cable	-Data Processing Cable -Industrial Cable -Transit Cable	-Plenum Cable

Note: *Varies with formulation **Based upon Copolymer — Data Not Available

TEFLON is a trademark of E. I. du Pont de Nemours & Company

Technical Information

Shields

The increasing number of high frequency interference sources has emphasized the necessity for shielding in electronic equipment. Shields, are used for EMI and RFI protection.

If a shield is required, the end user has a choice among several options - braided copper wire; spiral (served) copper wire; copper and aluminum tapes; laminates of aluminum/polyester and aluminum/polyester/aluminum with spiral drain wires for ease of termination; semi-conductive plastics.

The most effective for high frequency applications is a braided copper shield. For the majority of audio frequency applications (20 to 20,000 Hz) a coverage of 75% to 85% will prove effective, but for the high frequency range (3 to 30 MHz) a coverage of 85% to 95% will be necessary to give adequate protection.

The most economical shield is an aluminum polyester laminated tape used in conjunction with a drain wire applied either spirally or longitudinally, directly adjacent to the aluminum side of the tape. For frequencies up to 400 MHz it is as effective as a braid copper shield since it provides 100% coverage.

Cables

Cabling of individual layers may be either concentric or bunched. The **concentric** lay-up consists of a central wire or filler surrounded by one or more layers of helically laid wires, with the direction of lay reversed for successive layers and with the length of lay increasing for each successive layer. The direction of lay of the outer layer is generally left-hand. This construction assures cable roundness and greater mechanical strength. A **bunched** or **unilay** cable lay-up consists of any number of insulated wires cabled together in the same direction. It results in a smaller overall cable diameter, lighter weight, and has greater flexibility than concentric lay-ups.

Flexibility of a cable is directly related to the lay length of the individual layers. Usually this is 8 to 16 times the pitch diameter of each layer; the smaller the lay length, the greater the flexibility of the cable.

Fillers, are used to round out a cable and obtain symmetry.

Binders and Servers, sometimes needed (depending on construction) to prevent flaring or untwisting of components.

Tapes are frequently placed under the outer jacket as an added protection against mechanical abuse, and between overall shields and underlying conductors to prevent physical damage to the insulation.

onlinecomponents.com



Electronics

Color Chart

Multi-Conductor Cables

Table A

Number of Conductors	Base Color	1st Stripe/ Bandmark	2nd Stripe/ Bandmark
1	Black		
2	Brown		
3	Red		
4	Orange		
5	Yellow		
6	Green		
7	Blue		
8	Violet		
9	Gray		
10	White		
11	White	Black	
12	White	Brown	
13	White	Red	
14	White	Orange	
15	White	Yellow	
16	White	Green	
17	White	Blue	
18	White	Violet	
19	White	Gray	
20	White	Black	Brown
21	White	Black	Red
22	White	Black	Orange
23	White	Black	Yellow
24	White	Black	Green
25	White	Black	Blue
26	White	Black	Violet
27	White	Black	Gray
28	White	Brown	Red
29	White	Brown	Orange
30	White	Brown	Yellow
31	White	Brown	Green
32	White	Brown	Blue
33	White	Brown	Violet
34	White	Brown	Gray
35	White	Red	Orange
36	White	Red	Yellow
37	White	Red	Green
38	White	Red	Blue
39	White	Red	Violet
40	White	Red	Gray
41	White	Orange	Yellow
42	White	Orange	Green
43	White	Orange	Blue
44	White	Orange	Violet
45	White	Orange	Gray
46	White	Yellow	Green
47	White	Yellow	Blue
48	White	Yellow	Violet
49	White	Yellow	Gray
50	White	Green	Blue
51	White	Green	Violet
52	White	Green	Gray
53	White	Blue	Violet
54	White	Blue	Gray
55	White	Violet	Gray

Table B

Number of Conductors	Base Color	1st Stripe/ Bandmark	2nd Stripe/ Bandmark
1	Black		
2	Red		
3	White		
4	Green		
5	Orange		
6	Blue		
7	Brown		
8	Yellow		
9	Violet		
10	Gray		
11	Pink		
12	Tan		
13	Red	Green	
14	Red	Yellow	
15	Red	Black	
16	White	Black	
17	White	Red	
18	White	Green	
19	White	Yellow	
20	White	Blue	
21	White	Brown	
22	White	Orange	
23	White	Gray	
24	White	Violet	
25	White	Black	Red
26	White	Black	Green
27	White	Black	Yellow
28	White	Black	Blue
29	White	Black	Brown
30	White	Black	Orange
31	White	Black	Gray
32	White	Black	Violet
33	White	Black	Black
34	White	Red	Black
35	White	Red	Red
36	White	Red	Green
37	White	Red	Blue
38	White	Red	Brown
39	White	Red	Violet
40	White	Green	Black
41	White	Green	Red
42	White	Green	Green
43	White	Green	Blue
44	White	Green	Brown
45	White	Green	Violet
46	White	Blue	Black
47	White	Blue	Red
48	White	Blue	Green
49	White	Blue	Blue
50	White	Blue	Brown
51	White	Blue	Violet
52	White	Brown	Black
53	White	Brown	Red
54	White	Brown	Green
55	White	Brown	Blue
56	White	Brown	Brown
57	White	Brown	Violet
58	White	Violet	Red
59	White	Violet	Green
60	White	Violet	Blue

Multi-Pair Cables

Table C

Pair Number	Color Combination
1	Black paired with Red
2	Black paired with White
3	Black paired with Green
4	Black paired with Blue
5	Black paired with Yellow
6	Black paired with Brown
7	Black paired with Orange
8	Red paired with White
9	Red paired with Green
10	Red paired with Blue
11	Red paired with yellow
12	Red paired with Brown
13	Red paired with Orange
14	Green paired with White
15	Green paired with Blue
16	Green paired with Yellow
17	Green paired with Brown
18	Green paired with Orange
19	White paired with Blue
20	White paired with Yellow
21	White paired with Brown
22	White paired with Orange
23	Blue paired with Yellow
24	Blue paired with Brown
25	Blue paired with Orange
26	Brown paired with Yellow
27	Brown paired with Orange
28	Orange paired with Yellow
29	Violet paired with Orange
30	Violet paired with Red
31	Violet paired with White
32	Violet paired with Green
33	Violet paired with Blue
34	Violet paired with Yellow
35	Violet paired with Brown
36	Violet paired with Black
37	Gray paired with White

Technical Information



Electronics

Color Chart (Continued)

Multi-Pair Cables (Continued)

Table D

Pair Number	Color Combination
1	White paired with Black
2	White paired with Brown
3	White paired with Red
4	White paired with Orange
5	White paired with Yellow
6	White paired with Green
7	White paired with Blue
8	White paired with Violet
9	White paired with Gray
10	Black paired with Brown
11	Black paired with Red
12	Black paired with Orange
13	Black paired with Yellow
14	Black paired with Green
15	Black paired with Blue
16	Black paired with Violet
17	Black paired with Gray
18	Brown paired with Red
19	Brown paired with Orange
20	Brown paired with Yellow
21	Brown paired with Green
22	Brown paired with Blue
23	Brown paired with Violet
24	Brown paired with Gray
25	Red paired with Orange
26	Red paired with Yellow
27	Red paired with Green
28	Red paired with Blue
29	Red paired with Violet
30	Red paired with Gray
31	Orange paired with Yellow
32	Orange paired with Green
33	Orange paired with Blue
34	Orange paired with Violet
35	Orange paired with Gray
36	Yellow paired with Green
37	Yellow paired with Blue
38	Yellow paired with Violet
39	Yellow paired with Gray
40	Green paired with Blue
41	Green paired with Violet
42	Green paired with Gray
43	Blue paired with Violet
44	Blue paired with Gray
45	Violet paired with Gray
46	White/Black paired with Black
47	White/Black paired with Brown
48	White/Black paired with Red
49	White/Black paired with Orange
50	White/Black paired with Yellow
51	White/Black paired with Green
52	White/Black paired with Blue
53	White/Black paired with Violet
54	White/Black paired with Gray
55	White/Brown paired with Black
56	White/Brown paired with Brown
57	White/Brown paired with Red
58	White/Brown paired with Orange
59	White/Brown paired with Yellow

Table D (continued)

Pair Number	Color Combination
60	White/Brown paired with Green
61	White/Brown paired with Blue
62	White/Brown paired with Violet
63	White/Red paired with Gray
64	White/Red paired with Black
65	White/Red paired with Brown
66	White/Red paired with Red
67	White/Red paired with Orange
68	White/Red paired with Yellow
69	White/Red paired with Green
70	White/Red paired with Blue
71	White/Red paired with Violet
72	White/Red paired with Gray
73	White/Orange paired with Black
74	White/Orange paired with Brown
75	White/Orange paired with Red
76	White/Orange paired with Orange
77	White/Orange paired with Yellow
78	White/Orange paired with Green
79	White/Orange paired with Blue
80	White/Orange paired with Violet
81	White/Orange paired with Gray
82	White/Yellow paired with Black
83	White/Yellow paired with Brown
84	White/Yellow paired with Red
85	White/Yellow paired with Orange
86	White/Yellow paired with Yellow
87	White/Yellow paired with Green
88	White/Yellow paired with Blue
89	White/Yellow paired with Violet
90	White/Yellow paired with Gray
91	White/Green paired with Black
92	White/Green paired with Brown
93	White/Green paired with Red
94	White/Green paired with Orange
95	White/Green paired with Yellow
96	White/Green paired with Green
97	White/Green paired with Blue
98	White/Green paired with Violet
99	White/Green paired with Gray

Table E

Pair Number	Color Combination
1	Black paired with White
2	Red paired with Green
3	Brown paired with Blue
4	Orange paired with Yellow
5	Violet paired with Gray
6	Tan paired with Pink
7	White/Blue paired with Blue/White
8	White/Brown paired with Brown/White
9	White/Orange paired with Orange/White
10	White/Green paired with Green/White
11	White/Red paired with Red/White
12	White/Black paired with Black/White
13	White/Gray paired with Gray/White
14	Red/Blue paired with Blue/Red
15	Red/Orange paired with Orange/Red
16	Red/Green paired with Green/Red
17	Red/Brown paired with Brown/Red
18	Red/Gray paired with Gray/Red
19	Black/Blue paired with Blue/Black
20	Black/Orange paired with Orange/Black
21	Black/Green paired with Green/Black
22	Black/Brown paired with Brown/Black
23	Black/Gray paired with Gray/Black
24	Yellow/Blue paired with Blue/Yellow
25	Yellow/Orange paired with Orange/Yellow

*Single conductor - Green/Yellow

Technical Information



Electronics

Color Chart (Continued)

Multi-Pair Cables (Continued)

Table F

Pair Number	Color Combination
1	White/Black paired with Black/White
2	White/Brown paired with Brown/White
3	White/Red paired with Red/White
4	White/Orange paired with Orange/White
5	White/Yellow paired with Yellow/White
6	White/Green paired with Green/White
7	White/Blue paired with Blue/White
8	White/Violet paired with Violet/White
9	White/Gray paired with Gray/White
10	Black/Brown paired with Brown/Black
11	Black/Red paired with Red/Black
12	Black/Orange paired with Orange/Black
13	Black/Yellow paired with Yellow/Black
14	Black/Green paired with Green/Black
15	Black/Blue paired with Blue/Black
16	Black/Violet paired with Violet/Black
17	Black/Gray paired with Gray/Black
18	Brown/Red paired with Red/Brown
19	Brown/Orange paired with Orange/Brown
20	Brown/Yellow paired with Yellow/Brown
21	Brown/Green paired with Green/Brown
22	Brown/Blue paired with Blue/Brown
23	Brown/Violet paired with Violet/Brown
24	Brown/Gray paired with Gray/Brown
25	Red/Orange paired with Orange/Red
26	Red/Yellow paired with Yellow/Red
27	Red/Green paired with Green/Red
28	Red/Blue paired with Blue/Red
29	Red/Violet paired with Violet/Red
30	Red/Gray paired with Gray/Red
31	Orange/Yellow paired with Yellow/Orange
32	Orange/Green paired with Green/Orange
33	Orange/Blue paired with Blue/Orange
34	Orange/Violet paired with Violet/Orange
35	Orange/Gray paired with Gray/Orange
36	Yellow/Green paired with Green/Yellow
37	Yellow/Blue paired with Blue/Yellow
38	Yellow/Violet paired with Violet/Yellow
39	Yellow/Gray paired with Gray/Yellow
40	Green/Blue paired with Blue/Green
41	Green/Violet paired with Violet/Green
42	Green/Gray paired with Gray/Green
43	Blue/Violet paired with Violet/Blue
44	Blue/Gray paired with Gray/Blue
45	Violet/Gray paired with Gray/Violet

Table G (continued)

13	Tan/Yellow paired with Yellow/Tan
14	Tan/Green paired with Green/Tan
15	Tan/Blue paired with Blue/Tan
16	Tan/Violet paired with Violet/Tan
17	Tan/Gray paired with Gray/Tan
18	Brown/Pink paired with Pink/Brown
19	Brown/Orange paired with Orange/Brown
20	Brown/Yellow paired with Yellow/Brown
21	Brown/Green paired with Green/Brown
22	Brown/Blue paired with Blue/Brown
23	Brown/Violet paired with Violet/Brown
24	Brown/Gray paired with Gray/Brown
25	Pink/Orange paired with Orange/Pink
26	Pink/Yellow paired with Yellow/Pink
27	Pink/Green paired with Green/Pink
28	Pink/Blue paired with Blue/Pink
29	Pink/Violet paired with Violet/Pink
30	Pink/Gray paired with Gray/Pink
31	Orange/Yellow paired with Yellow/Orange
32	Orange/Green paired with Green/Orange
33	Orange/Blue paired with Blue/Orange
34	Orange/Violet paired with Violet/Orange
35	Orange/Gray paired with Gray/Orange
36	Yellow/Green paired with Green/Yellow
37	Yellow/Blue paired with Blue/Yellow
38	Yellow/Violet paired with Violet/Yellow
39	Yellow/Gray paired with Gray/Yellow
40	Green/Blue paired with Blue/Green
41	Green/Violet paired with Violet/Green
42	Green/Gray paired with Gray/Green
43	Blue/Violet paired with Violet/Blue
44	Blue/Gray paired with Gray/Blue
45	Violet/Gray paired with Gray/Violet
46	Aqua/Tan paired with Tan/Black
47	Aqua/Brown paired with Brown/Black
48	Aqua/Pink paired with Pink/Black
49	Aqua/Orange paired with Orange/Black
50	Aqua/Yellow paired with Yellow/Black
51	Aqua/Green paired with Green/Black
52	Aqua/Blue paired with Blue/Black
53	Aqua/Violet paired with Violet/Black
54	Aqua/Gray paired with Gray/Black
55	Aqua/White paired with White/Black
56	White paired with Tan
57	Gray paired with Brown
58	Blue paired with Pink
59	Violet paired with Orange
60	Green paired with Yellow

Table H (continued)

9	Red/Brown paired with Brown/Red
10	Red/Gray paired with Gray/Red
11	Black/Blue paired with Blue/Black
12	Black/Orange paired with Orange/Black
13	Black/Green paired with Green/Black
14	Black/Brown paired with Brown/Black
15	Black/Gray paired with Gray/Black
16	Yellow/Blue paired with Blue/Yellow
17	Yellow/Orange paired with Orange/Yellow
18	Yellow/Green paired with Green/Yellow
19	Yellow/Brown paired with Brown/Yellow
20	Yellow/Gray paired with Gray/Yellow
21	Violet/Blue paired with Blue/Violet
22	Violet/Orange paired with Orange/Violet
23	Violet/Green paired with Green/Violet
24	Violet/Brown paired with Brown/Violet
25	Violet/Gray paired with Gray/Violet

Table I

Pair Number	Color Combination
1	Black/Red paired with Red/Black
2	Black/White paired with White/Black
3	Black/Green paired with Green/Black
4	Black/Blue paired with Blue/Black
5	Black/Yellow paired with Yellow/Black
6	Black/Brown paired with Brown/Black
7	Black/Orange paired with Orange/Black
8	Red/White paired with White/Red
9	Red/Green paired with Green/Red
10	Red/Blue paired with Blue/Red
11	Red/Yellow paired with Yellow/Red
12	Red/Brown paired with Brown/Red
13	Red/Orange paired with Orange/Red
14	Green/White paired with White/Green
15	Green/Blue paired with Blue/Green
16	Green/Yellow paired with Yellow/Green
17	Green/Brown paired with Brown/Green
18	Green/Orange paired with Orange/Green
19	White/Blue paired with Blue/White
20	White/Yellow paired with Yellow/White
21	White/Brown paired with Brown/White
22	White/Orange paired with Orange/White
23	Blue/Yellow paired with Yellow/Blue
24	Blue/Brown paired with Brown/Blue
25	Blue/Orange paired with Orange/Blue

Table G

Pair Number	Color Combination
1	White/Tan paired with Tan/White
2	White/Brown paired with Brown/White
3	White/Pink paired with Pink/White
4	White/Orange paired with Orange/White
5	White/Yellow paired with Yellow/White
6	White/Green paired with Green/White
7	White/Blue paired with Blue/White
8	White/Violet paired with Violet/White
9	White/Gray paired with Gray/White
10	Tan/Brown paired with Brown/Tan
11	Tan/Pink paired with Pink/Tan
12	Tan/Orange paired with Orange/Tan

Table H

Pair Number	Color Combination
1	White/Blue paired with Blue/White
2	White/Orange paired with Orange/White
3	White/Green paired with Green/White
4	White/Brown paired with Brown/White
5	White/Gray paired with Gray/White
6	Red/Blue paired with Blue/Red
7	Red/Orange paired with Orange/Red
8	Red/Green paired with Green/Red

Technical Information