

# SERIESONE DR SERIES | AC OUTPUT

## DIN RAIL MOUNT SOLID STATE RELAYS

Sensata | Crydom SeriesOne DR family of DIN Rail mount Solid State Relays incorporate proprietary thermal management technology to achieve exceptional output ratings of 3, 6 and 12 Amps at 24 to 600 VAC in compact 11mm and 18mm wide housings. These compact SSRs are ideal for use in demanding applications where space may be limited, providing greater power density than other DIN Rail Solid State Relays.



3, 6 Amps



12 Amps

### Features

- Ratings of 3, 6 & 12 Amps
- Load voltage ratings of 24-280 VAC and 48-600 VAC
- Fits standard 35mm DIN Rail
- LED input status indicator
- AC or DC control
- Zero Voltage (resistive loads) or Instantaneous (inductive loads) turn-on output
- UL and cUL Listed, HP Rated, CE & RoHS Compliant
- UL 508 Endurance Rating for Enhanced Reliability
- UL Class I and II, Division 2, for Hazardous Locations

### Applications

- Industrial ovens
- Plastic injection molding equipment
- Packaging equipment
- Professional cooking equipment
- Lighting control
- HVAC&R

## PRODUCT SELECTION

Control Voltage	280V, 3 A	280V, 6 A	280V, 12 A	600V, 3 A	600V, 6 A	600V, 12 A
<b>4-32 VDC</b>	DR24D03	DR24D06	DR24D12	DR48D03	DR48D06	DR48D12
<b>90-140 VAC</b>	DR24B03	DR24B06	DR24B12			DR48B12
<b>200-280 VAC</b>	DR24A03	DR24A06	DR24A12			DR48A12
<b>18-36 VAC</b>	DR24E03	DR24E06	DR24E12			DR48E12

Output <sup>(1)</sup>

Description	DR24x03	DR24x06	DR24x12	DR48x03	DR48x06	DR48X12
<b>Operating Voltage Range (47-63Hz) [Vrms]</b>	24-280	24-280	24-280	48-600	48-600	48-600
<b>Transient Overvoltage [Vpk]</b>	600	600	600	1200	1200	1200
<b>Maximum Load Current, resistive [Arms] <sup>(2)</sup></b>	3	6	12	3	6	12
<b>Minimum Load Current [mArms]</b>	150	150	150	150	150	150
<b>Maximum Off-State Leakage Current @ Rated Voltage [mArms]</b>	0.1	0.1	0.1	0.1	0.1	0.1
<b>Minimum Off-State dv/dt @ Maximum Rated Voltage [V/μsec] <sup>(3)</sup></b>	500	500	500	500	500	500
<b>Maximum On-State Voltage Drop @ Rated Current [Vrms]</b>	1.3	1.3	1.3	1.3	1.3	1.3
<b>Maximum Surge Current (50/60Hz, 1 cycle) [Apk]</b>	285/300	285/300	715/750	285/300	285/300	715/750
<b>Maximum I<sup>2</sup>t for Fusing (50/60 Hz, 1/2 cycle) [A<sup>2</sup> sec]</b>	410/375	410/375	2560/2330	410/375	410/375	2560/2330
<b>HP Rating UL 508/IEC60947 [HP (KW)] @ 240V</b>	1/4 (.18)	1/2 (.37)	1 (.75)	1.4 (.18)	1/2 (.37)	1 (.75)
<b>HP Rating UL 508/IEC60947 [HP (KW)] @ 380V</b>	N/A	1 (.75)	2 (1.5)	1/3 (.25)	1 (1.5)	2 (1.5)
<b>HP Rating UL 508/IEC60947 [HP (KW)] @ 480V</b>	N/A	N/A	3 (2.2)	1/2 (.37)	2 (1.5)	3 (2.2)
<b>Minimum Power Factor (at Maximum Load)</b>	0.5	0.5	0.5	0.5	0.5	0.5
<b>Min/Max stranded wire</b>	22/14 AWG	22/14 AWG	22/14 AWG	22/14 AWG	22/14 AWG	22/14 AWG
<b>Min/Max solid wire</b>	22/14 AWG	22/14 AWG	22/14 AWG	22/14 AWG	22/14 AWG	22/14 AWG
<b>Weight (Typical)</b>	1.76 oz (50 g)	1.76 oz (50 g)	3.17 oz. (90g)	1.76 oz (50 g)	1.76 oz (50 g)	3.17 oz. (90g)

Input <sup>(1)</sup>

Description	DRxxDxx	DRxxBxx	DRxxAxx	DRxxExx
<b>Control Voltage Range <sup>(3)</sup></b>	4-32 VDC	90-140 Vrms	200-265 Vrms	18-36 Vrms <sup>(5)</sup>
<b>Minimum Turn-On Voltage</b>	4.0 VDC	90 Vrms	200 Vrms	18 Vrms
<b>Must Turn-Off Voltage</b>	1.0 VDC	10 Vrms	40 Vrms	4 Vrms
<b>Minimum Input Current for [mA] <sup>(4)</sup></b>	9	3	2.5	3.5
<b>Maximum Input Current for [mA] <sup>(4)</sup></b>	11	5	3.3	8
<b>Maximum Turn-on Time [msec] <sup>(5)</sup></b>	1/2 Cycle	20 msec	20 msec	20 msec
<b>Maximum Turn-off Time [msec]</b>	1/2 Cycle	30 msec	30 msec	30 msec
<b>Min/Max stranded/solid wire</b>	22/16 AWG	22/16 AWG	22/16 AWG	22/16 AWG

## General <sup>(2)</sup>

Description	Parameters
<b>Dielectric Strength, Input/Output/Base (50/60Hz)</b>	4000 Vrms
<b>Minimum Insulation Resistance (@ 500 V DC)</b>	10 <sup>9</sup> Ohms
<b>Maximum Capacitance, Input/Output</b>	10 pF
<b>Ambient Operating Temperature Range</b>	-30 to 80 °C
<b>Ambient Storage Temperature Range</b>	-30 to 100 °C
<b>Recommended Terminal Screw Torque Range</b>	4.4-7.0 lb-in (0.5-0.8 Nm)



## MECHANICAL SPECIFICATIONS <sup>(1)</sup>

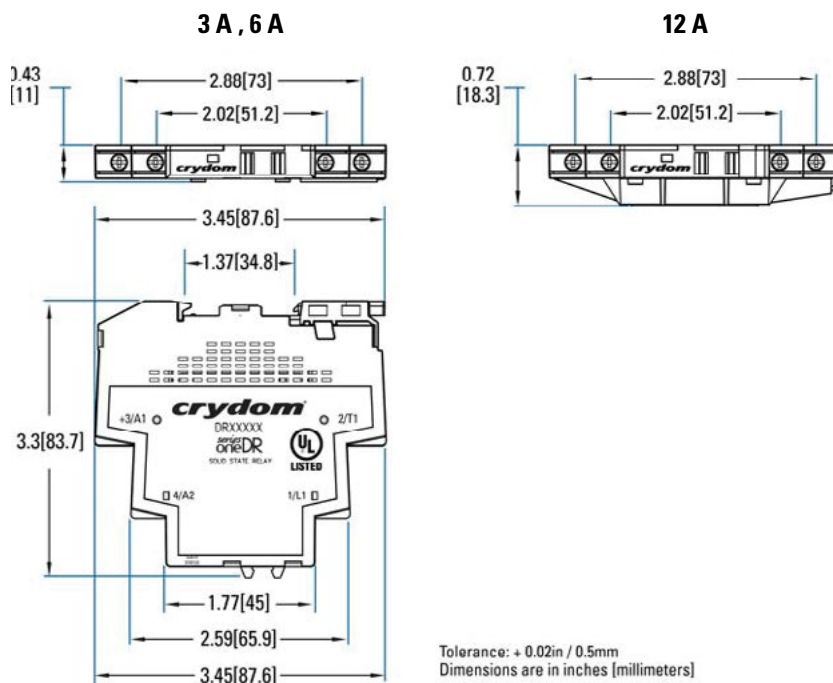

## EQUIVALENT CIRCUIT BLOCK DIAGRAMS/WIRING DIAGRAMS

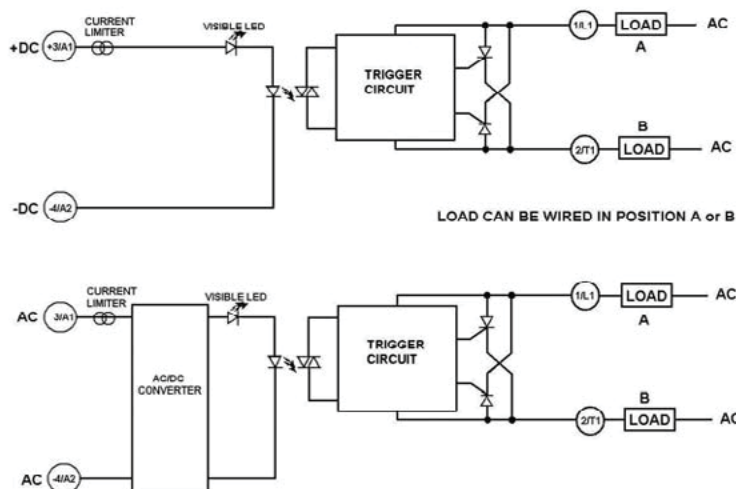



## THERMAL DERATE INFORMATION

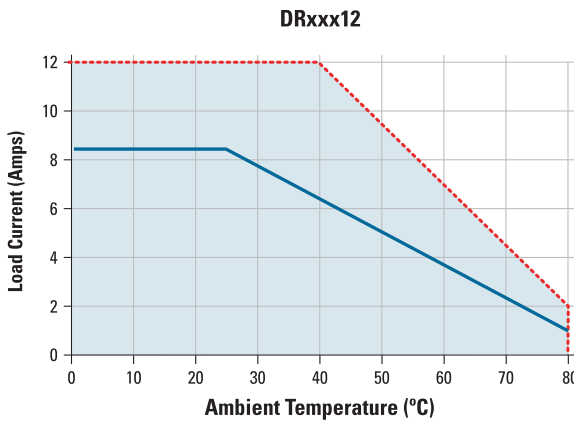
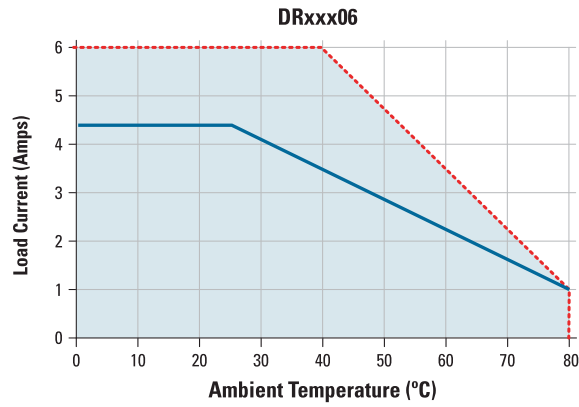
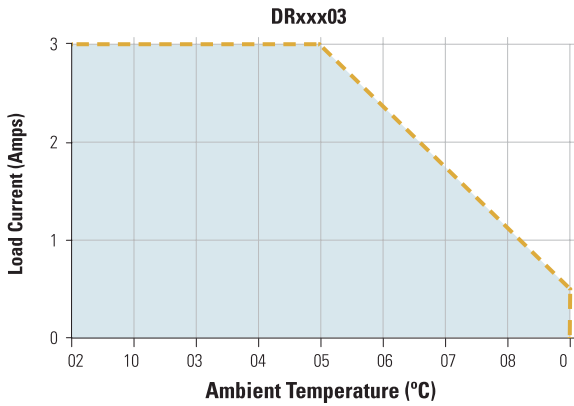

- Single and multiple units (for DRxxx03)
- Single unit, distance to adjacent components  $\geq 11$  mm for DRxxx06 and  $\geq 18$  mm for DRxxx12
- Multiple units, no minimum spacing between components



## STANDARDS OF COMPLIANCE

### IEC 62314

LC A, Resistive or Slightly Inductive Load Ratings: 3A @40°C ambient for DR24x03, 3A @ 40°C ambient for DR48x03  
 LC A, Resistive or Slightly Inductive Load Ratings: 12 A @40°C ambient for DR24x12, 12 A @ 40°C ambient for DR48x12  
 LC A, Resistive or Slightly Inductive Load Ratings: 6 A @ 40°C ambient for DR24x06, 6 A @ 40°C ambient for DR48x06

LC B, Motor Loads Ratings: 0.18KW @ 240VAC for DR24x03 and 0.375KW @ 480VAC DR48x03  
 LC B, Motor Loads Ratings: 0.75KW @ 240 VAC for DR24x06 and 2.2KW @ 480 VAC DR48x12  
 LC B, Motor Loads Ratings: 0.375KW @ 240 VAC for DR24x06 and 1.5KW @ 480 VAC DR48x12

### Shock and Vibration (Applies to all part numbers)

Vibration Resistance according to IEC 60068-2-6: **0.35mm and 0.75mm Amplitude over 10-55 Hz**  
 Shock Resistance according to IEC 60068-2-27: **15g/11ms**

### EMC (Applies to all part numbers)

IEC 61000-4-2: Electrostatic Discharge- Level 3  
 IEC 61000-4-4: Electrically Fast Transients- Level 3  
 IEC 61000-4-5: Electrical Surges- Level 3

### ANSI / ISA 12.12.01-2013

Nonincendive Electrical Equipment for Use in Class I and II, Division 2 and Class III, Division 1 and 2 Hazardous (classified) locations  
 This equipment is open-type device and is meant to be installed in an enclosure suitable for the environment such that the equipment is only accessible with the use of a tool suitable for use in Class 1, Division 2, Group A,B,C and Hazardous locations, or Nonhazardous locations only

WARNING-Explosion Hazard- Do not disconnect equipment while the circuit is live or unless the area is known to be free of ignitable concentrations  
 WARNING-Explosion Hazard- Substitution of any component may impair suitability for Class I, Division 2



# ORDERING OPTIONS

Example : DR24D12R

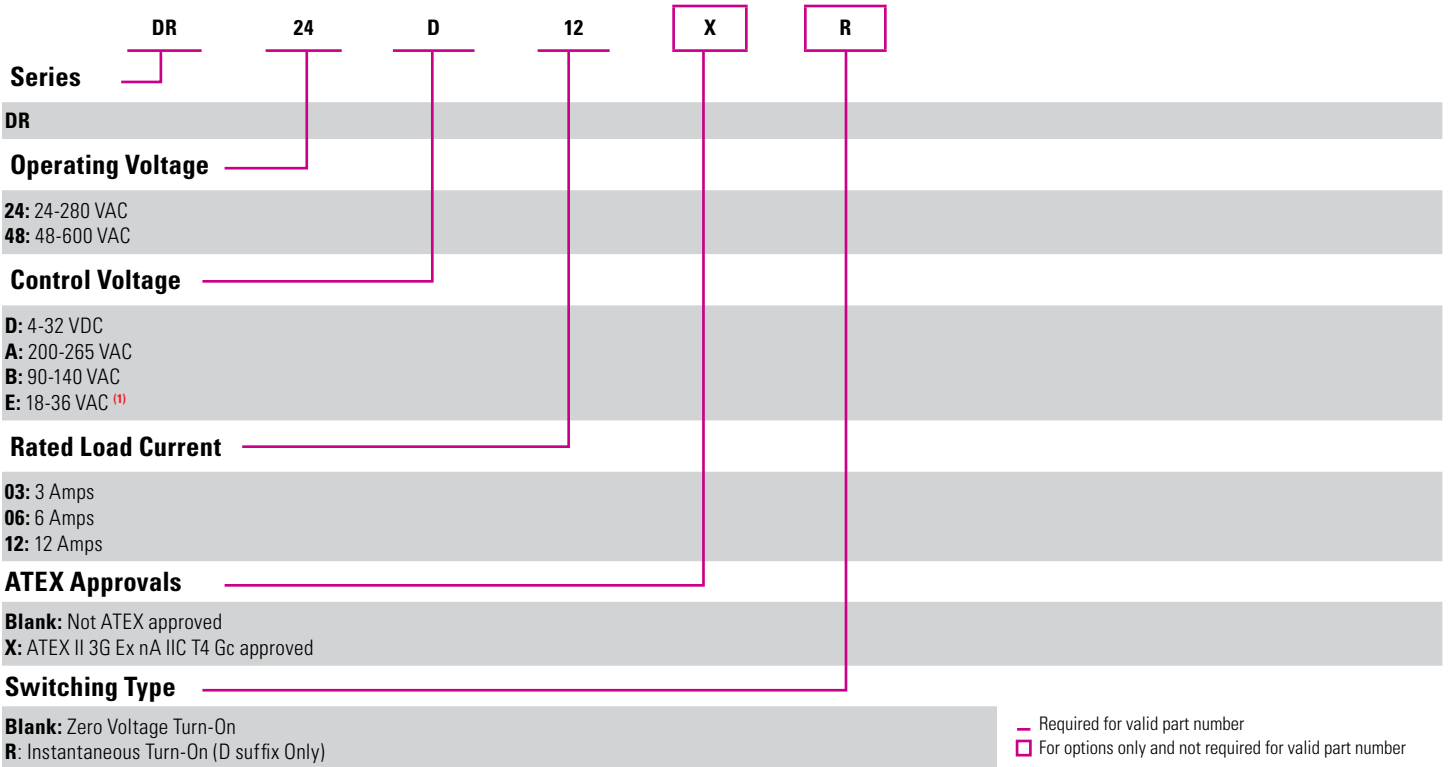

## GENERAL NOTES

- <sup>(1)</sup> All parameters at 25°C unless otherwise specified.
- <sup>(2)</sup> See Derating curves
- <sup>(3)</sup> Off-State dv/dt test method per EIA/NARM standard RS-443, paragraph 13.11.1
- <sup>(4)</sup> DC control includes reverse polarity protection.
- <sup>(5)</sup> E option is UL certified for AC control voltage, but it works also with 18-36 VDC input range.
- <sup>(6)</sup> Input circuitry incorporates active current limiter.
- <sup>(7)</sup> Turn-on time for DC control random turn-on versions is 0.1 msec.



## AGENCY APPROVALS & CERTIFICATIONS

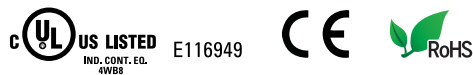





## ACCESSORIES

### ID Marker Strips

#### CNLB, CNLN, CNL2

		
<b>Black Strips</b> Part no.: CNLB	<b>Numbered 1 to 10 Strips</b> Part no.: CNLN	<b>Numbered 11 to 20 Strips</b> Part no.: CNL2
A package of 10 plastic strips comprising 10 individual unprinted markers which can be placed on sockets' terminal block for easy identification during the use of multiple units.	A package of 10 plastic strips comprising 10 markers printed individually from 1 to 10 which can be placed on sockets' terminal block for easy identification during the use of multiple units.	A package of 10 plastic strips comprising 10 markers printed individually from 11 to 20 which can be placed on sockets' terminal block for easy identification during the use of multiple units.



## WARNINGS



#### RISK OF MATERIAL DAMAGE AND HOT ENCLOSURE

- The product's side panels may be hot, allow the product to cool before touching
- Follow proper mounting instructions including torque values
- Do not allow liquids or foreign objects to enter this product

**Failure to follow these instructions can result in serious injury, or equipment damage.**



#### HAZARD OF ELECTRIC SHOCK, EXPLOSION OR ARC FLASH

- Disconnect all power before installing or working with this equipment
- Verify all connections and replace all covers before turning on power

**Failure to follow these instructions will result in death or serious injury.**

Sensata Technologies, Inc. ("Sensata") data sheets are solely intended to assist designers ("Buyers") who are developing systems that incorporate Sensata products (also referred to herein as "components"). Buyer understands and agrees that Buyer remains responsible for using its independent analysis, evaluation and judgment in designing Buyer's systems and products. Sensata data sheets have been created using standard laboratory conditions and engineering practices. Sensata has not conducted any testing other than that specifically described in the published documentation for a particular data sheet. Sensata may make corrections, enhancements, improvements and other changes to its data sheets or components without notice.

Buyers are authorized to use Sensata data sheets with the Sensata component(s) identified in each particular data sheet. HOWEVER, NO OTHER LICENSE, EXPRESS OR IMPLIED, BY ESTOPPEL OR OTHERWISE TO ANY OTHER SENSATA INTELLECTUAL PROPERTY RIGHT, AND NO LICENSE TO ANY THIRD PARTY TECHNOLOGY OR INTELLECTUAL PROPERTY RIGHT, IS GRANTED HEREIN. SENSATA DATA SHEETS ARE PROVIDED "AS IS". SENSATA MAKES NO WARRANTIES OR REPRESENTATIONS WITH REGARD TO THE DATA SHEETS OR USE OF THE DATA SHEETS, EXPRESS, IMPLIED OR STATUTORY, INCLUDING ACCURACY OR COMPLETENESS. SENSATA DISCLAIMS ANY WARRANTY OF TITLE AND ANY IMPLIED WARRANTIES OF MERCHANTABILITY, FITNESS FOR A PARTICULAR PURPOSE, QUIET ENJOYMENT, QUIET POSSESSION, AND NON-INFRINGEMENT OF ANY THIRD PARTY INTELLECTUAL PROPERTY RIGHTS WITH REGARD TO SENSATA DATA SHEETS OR USE THEREOF.

All products are sold subject to Sensata's terms and conditions of sale supplied at [www.sensata.com](http://www.sensata.com) SENSATA ASSUMES NO LIABILITY FOR APPLICATIONS ASSISTANCE OR THE DESIGN OF BUYERS' PRODUCTS. BUYER ACKNOWLEDGES AND AGREES THAT IT IS SOLELY RESPONSIBLE FOR COMPLIANCE WITH ALL LEGAL, REGULATORY AND SAFETY-RELATED REQUIREMENTS CONCERNING ITS PRODUCTS, AND ANY USE OF SENSATA COMPONENTS IN ITS APPLICATIONS, NOTWITHSTANDING ANY APPLICATIONS-RELATED INFORMATION OR SUPPORT THAT MAY BE PROVIDED BY SENSATA.

Mailing Address: Sensata Technologies, Inc., 529 Pleasant Street, Attleboro, MA 02703, USA.

### CONTACT US

#### Americas

+1 (877) 502 5500 – Option 2  
[sales.crydom@sensata.com](mailto:sales.crydom@sensata.com)

#### Europe, Middle East & Africa

+44 (1202) 416170  
[ssr-info.eu@sensata.com](mailto:ssr-info.eu@sensata.com)

#### Asia Pacific

[sales.isasia@list.sensata.com](mailto:sales.isasia@list.sensata.com)  
China +86 (21) 2306 1500

Japan +81 (45) 277 7117

Korea +82 (31) 601 2004

India +91 (80) 67920890

Rest of Asia +886 (2) 27602006  
ext 2808