

THIS DOCUMENT IS THE PROPERTY OF
KEYSTONE ELECTRONICS CORP. AND
SHALL NOT BE REPRODUCED, DISTRIBUTED
OR USED AS A BASIS FOR MANUFACTURE
WITHOUT PRIOR WRITTEN PERMISSION
FROM KEYSTONE ELECTRONICS CORP.

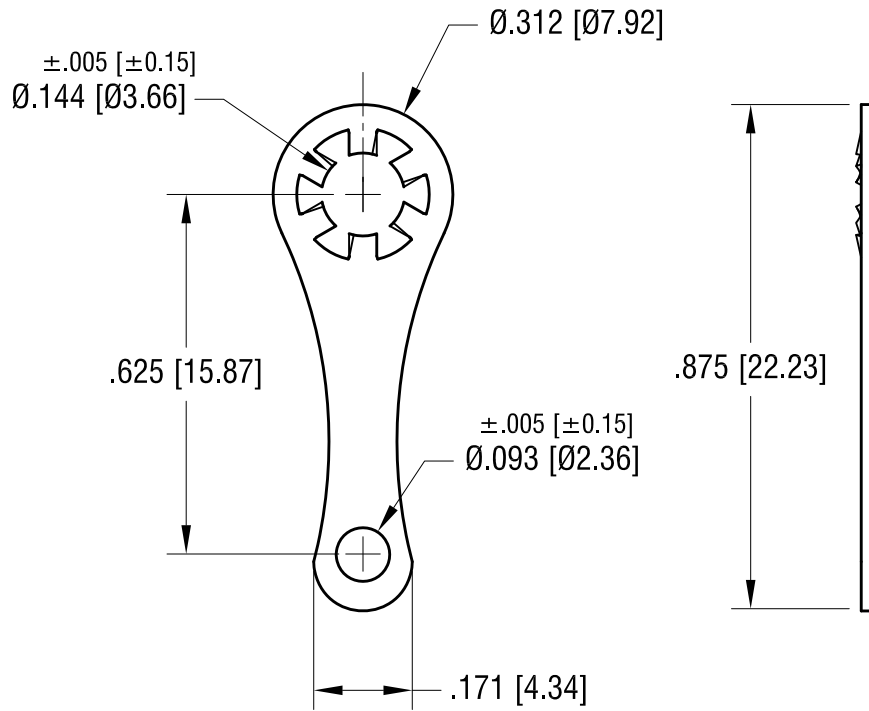

6.29.09	CHANGE AS PER ECN 09-099	B
10.17.08	CHANGE AS PER ECN 08-171	A
DATE	DESCRIPTION	REV.

KEYSTONE ELECTRONICS CORP.			
www.keyelco.com • ASTORIA, N.Y. 11105-2017 • Tel (718) 956-8900			
PART NAME			
LOCKWASHER TERMINAL LUG			
MATERIAL			
.018 [0.45] TH'K BRASS			
FINISH		DRN BY	DATE
MATTE TIN PLATE		BOONE	5.19.06
		APP'D	SCALE
		LN	3X
TOLERANCES	INCH [MM]	CODE	DWG NO.
DECIMAL	± .010 [± 0.25]	C	904
ANGULAR	± 1°		
UNLESS OTHERWISE SPECIFIED			