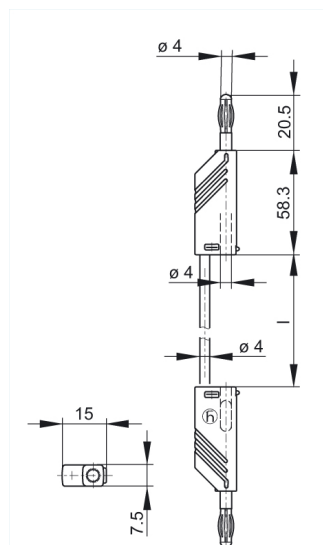

## Industrial Connectors:Measuring and Testing Equipment:Measuring leads:4 mm system

**Product description**

Description	Measuring lead,at either end 4 mm diameter plug with caged spring and 4 mm diameter socket for tower construction. Nickel-plated copper beryllium contact spring. Highly flexible, double insulated stranded lead, grip and lead shatter-proof. Built in colour indicator for easy identification of insulation damages.
Type	MLN 200/1 rot/red
Order No.	934 065-101
System	4 mm system
Cable length	200 cm
Conductor size	1 mm <sup>2</sup>
Cable material	PVC
Cable color	red
Housing Color	red
Other standard types	black color, order no. 934 065-100; blue color, order no. 934 065-102; yellow color, order no. 934 065-103; green color, order no. 934 065-104

**Drawing****Technical data**

Pin dimensions	4 mm
Type of contact	pin (spring loaded)
Type of termination	4 mm diameter pin and socket
Cable type	LEH-XY
Cable specification	highly flexible lead

Wire stranding	259 x 0,07
Rated voltage	DC 60 V
Rated current	16 A
Contact resistance	40 mOhm
<b>Material</b>	
Contact material	contact pin: brass, contact spring: copper beryllium
Contact surface material	nickel-plated
Housing material	PA
<b>Environmental conditions</b>	
Temperature range	-15 °C to +70 °C
<b>Inflammability class</b>	
Cable	94 HB
Housing	94 V-2