

VERTRAULICH-CONFIDENTIAL
 ● Alle Rechte bei Marquardt, auch fuer den Fall von Schutzrechtsanmeldungen. Jede Verfuegungsbefugnis, wie Kopier- und Weitergaberecht, bei uns.
 ● This document is the exclusive property of Marquardt. Without our consent, it may not be reproduced or given to third parties.

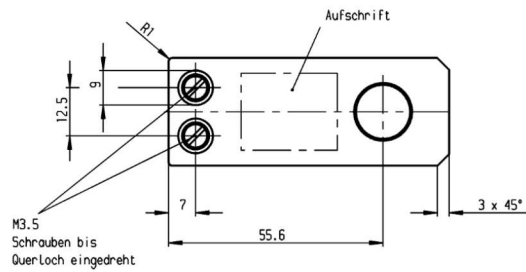
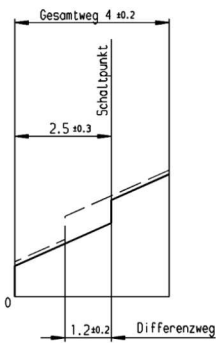
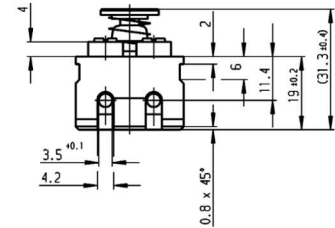
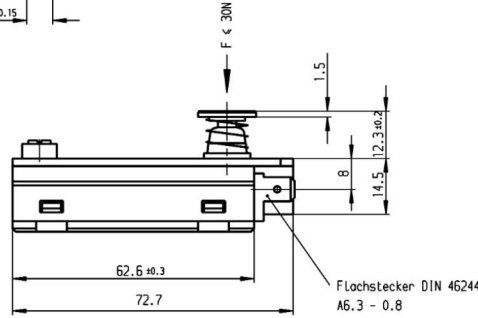
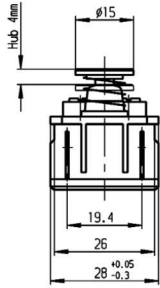
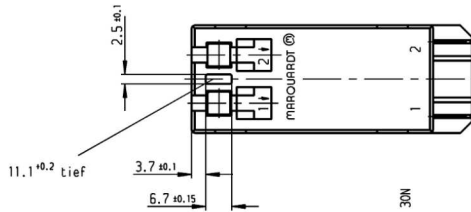

1) Aufschrift

1267.9101
 16(16)/250 ~SE4
 23(23)/127 ~SE4
 MARQUARDT
 Schaltbild
 Herstelljahr/ -woche
 auf Verpackung: 326 087-02

Schließer 2-polig
 Für Geräte der Klasse II geeignet.

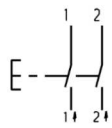

Allgemeintoleranzen/TOLERANCED DIMENSIONS				PROJECTION	Pause COPY	Blatt SHEET 01	Typ K	Zeichn./DRAWING NO. 1267.9101
Für Längen und Radien FOR LENGTHS AND RADII.		Abmaße in mm bis/UP TO 6 ober/OVER 6 bis/UP TO 30 ober/OVER 30						
t	±	0,2	0,4			Original DIN A3 Maßstab SCALE 1:1	gez./DRAWN BY 30.09.96 htd gepr./CHECKED BY Fo	GERAETESCHALTER switch
d								
e		79667	22.05.13 0Lb					MARQUARDT Marquardt GmbH, D-78604 Rietheim-Weilheim
b		27356	16.04.99 hng					
a		26769	23.11.98 hng					
Ausg. ISSUE	Änderung REVISION	gez./DRAWN BY	Ausg. ISSUE	Änderung REVISION	gez./DRAWN BY	Ersatz für/REPLACEMENT OF		

Schutzvermerk nach DIN 34 beachten COPYRIGHT RESERVED