

THIS DOCUMENT IS THE PROPERTY OF
KEYSTONE ELECTRONICS CORP. AND
SHALL NOT BE REPRODUCED, DISTRIBUTED
OR USED AS A BASIS FOR MANUFACTURE
WITHOUT PRIOR WRITTEN PERMISSION
FROM KEYSTONE ELECTRONICS CORP.

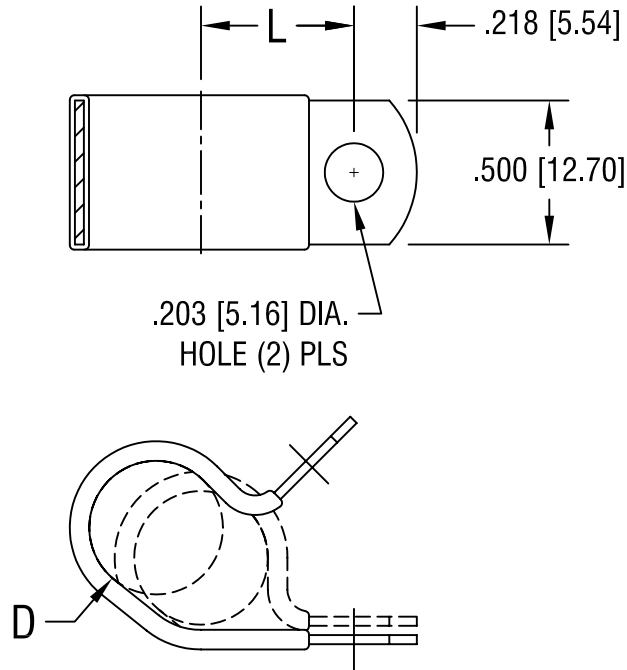

'L' DIM.	'D' FOR DIA.
.468 [11.89]	.312 [7.92]

KEYSTONE ELECTRONICS CORP.			
ASTORIA, N.Y. 11105-2017			
PART NAME INSULATED STEEL CABLE CLAMP			
MATERIAL .032 [.81] TH'K STEEL, BLACK VINYL			
FINISH ZINC PLATE CLEAR CHROMATE		DRN BY BOONE	DATE 10.20.99
		APP'D LN	SCALE NONE
10.18.06	CHANGE AS PER ECN 06-070	A	
DATE	DESCRIPTION	REV.	
TOLERANCES INCH [MM] DECIMAL ± .010 [± 0.25] ANGULAR ± 1° UNLESS OTHERWISE SPECIFIED		CODE C/M	DWG NO. 8123