

Extrusion

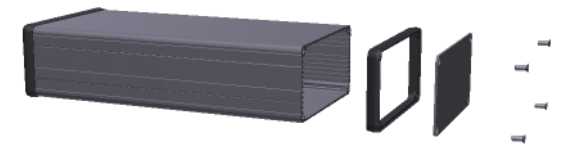

B

B

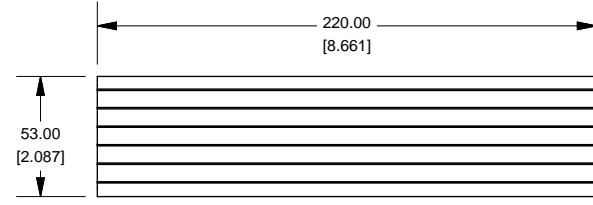
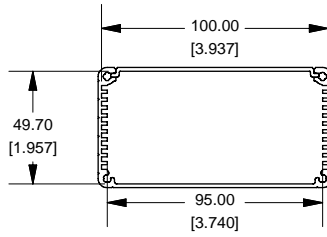
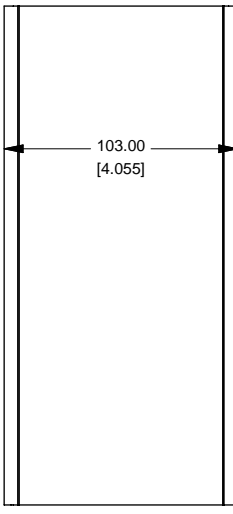

Slot Details

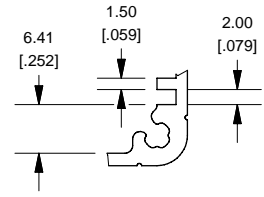

End Plate

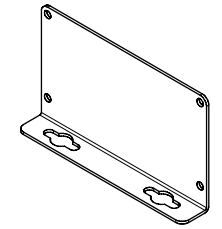
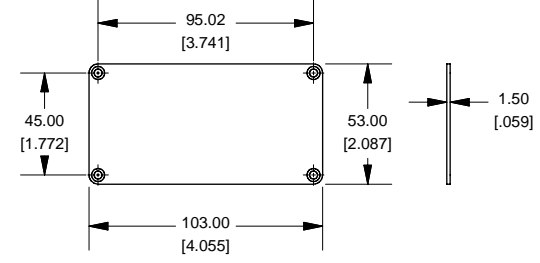

Open Bezel

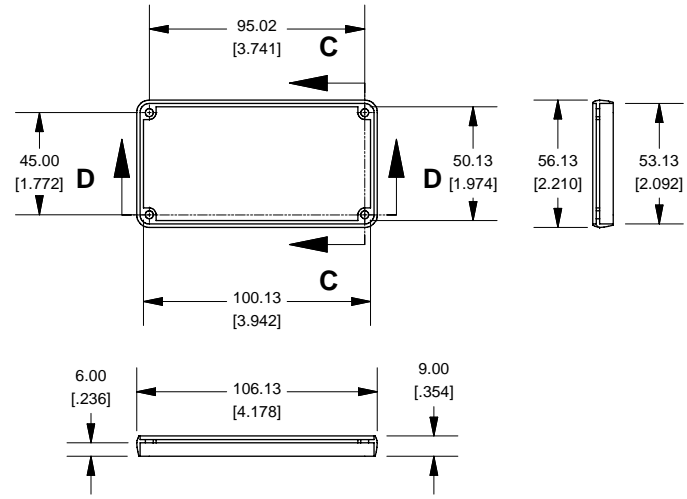

OPTIONAL FLANGE END PANELS 1455NF

Enclosures can be Factory Modified (Milling, Drilling, Printing etc.)
 Solid models of this enclosure available in STEP or IGES.
 Contact Factory mjm@hammondmfg.com

NOTE	
Purchased assembly includes box, plastic bezels, end panels, #6 Taptight screws and self adhesive rubber feet.	
Box made from Extruded Aluminum 6063.	
Bezels made with polycarbonate.	

1455N2201	
PART NUMBERS	
Clear Anodized	1455N2201
Black Anodized	1455N2201BK
ACCESSORIES	
See website for accessories.	

HAMMOND MANUFACTURING™
1455N2201
www.hammondmfg.com