

# 10 cm Breitbandsysteme / 4" Fullrange Systems



## R 10 SC

Art. No. 2040 – 4 Ω

Art. No. 2041 – 8 Ω

**Magnetisch abgeschirmter 10 cm (4") Breitbandlautsprecher** mit hohem Wirkungsgrad und ausgeglichenem Frequenzgang mit Hochtonanstieg. Dadurch sehr gute Sprachverständlichkeit. Wasserabweisende Membran und Gummidichtung. Besonders geeignet als Kontrolllautsprecher für elektronische Geräte und als Einbaulautsprecher für öffentliche Verkehrsmittel und Einrichtungen.

**Zubehör:** Schutzgitter (Art.-No. 4640, 4642, 4670)

**Magnetically shielded 10 cm (4") fullrange speaker** with high efficiency, balanced frequency response. Water-repellent cone and rubber gasket. Especially suitable as control speaker in electronic devices and as speaker for public applications and public transport systems.

**Accessories:** Protective grilles (Art.-No. 4640, 4642, 4670)



## FR 10

Art. No. 2020 – 4 Ω

Art. No. 2021 – 8 Ω

**10 cm (4") Breitbandlautsprecher** mit guten Tieftoneigenschaften, feuerverzinktem Korb, ausgeglichenem Frequenzgang und hohem Wirkungsgrad. Besonders geeignet als Einbaulautsprecher für die Musikwiedergabe sowie zur Bestückung von ELA-Zeilen.

**Zubehör:** Schutzgitter (Art. No. 4642, 4640, 4670)

**10 cm (4") fullrange speaker** with good bass reproduction, galvanized basket, balanced frequency response and high efficiency. Especially suitable as built-in speaker for music reproduction and as driver for 100 V network column speakers.

**Accessories:** Protective grille (Art. No. 4642, 4640, 4670)

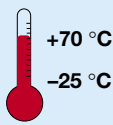
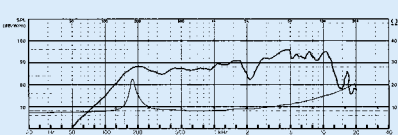
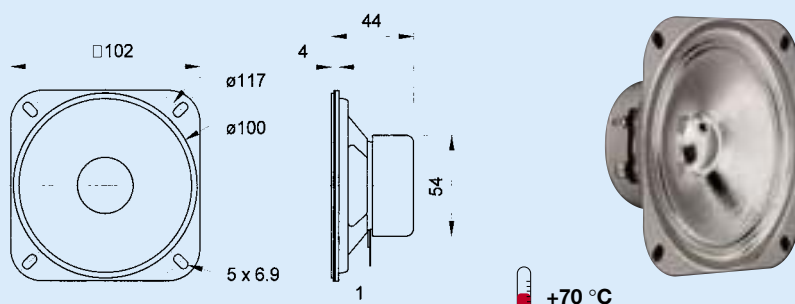

Art.-No. 4640

Art.-No. 4670

Art.-No. 4642

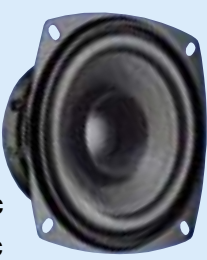
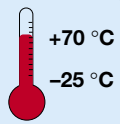
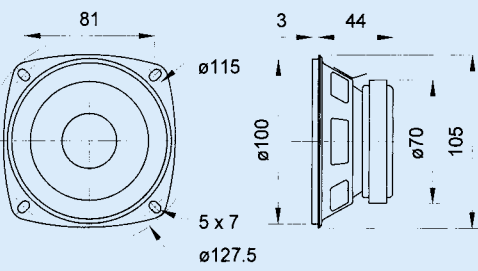
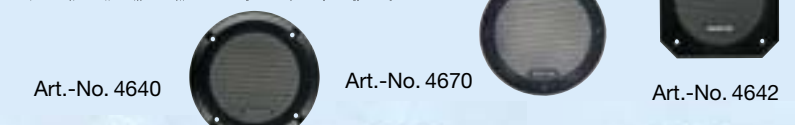

Art.-No. 4670

Art.-No. 4640

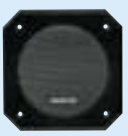
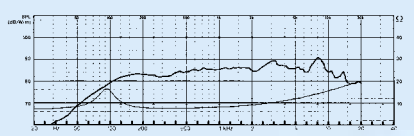

Art.-No. 4642



		R 10 SC	FR 10
Nennbelastbarkeit	Rated power	20 Watt	20 Watt
<b>Musikbelastbarkeit</b>	<b>Maximum power</b>	<b>30 Watt</b>	<b>30 Watt</b>
Impedanz	Impedance	4 + 8 Ω	4 + 8 Ω
Übertragungsbereich (-10 dB)	Frequency response (-10 dB)	100 – 13000 Hz	80 – 20000 Hz
Mittlerer Schalldruckpegel	Mean sound pressure level	90 dB (1 W / 1 m)	86 dB (1 W / 1 m)
Maximaler Hub	Maximum cone displacement	3 mm	8 mm
Resonanzfrequenz	Resonance frequency	163 Hz	97 Hz
Magnetische Induktion	Magnetic induction	0,95 Tesla	0,95 Tesla
Magnetischer Fluss	Magnetic flux	135 μ Weber	180 μ Weber
Obere Polplattenhöhe	Height of front pole-plate	3 mm	3 mm
Schwingspulen­durchmesser	Voice coil diameter	15 mm Ø	20 mm Ø
Wickelhöhe	Height of winding	4 mm	6 mm
Schallwandöffnung	Cutout diameter	93 mm Ø	100 mm Ø
Gewicht netto	Net weight	0,24 kg	0,38 kg

Weitere Daten Seiten 96 – 98 / for further data see pages 96 – 98