

Features

**2 Pole Changeover (DPDT)
30 A Power relay**

- 66.22** PCB connections & mount
- 66.82** Faston 250 connections
- Flange mount

- Reinforced insulation between coil and contacts according to EN 60335-1; 8 mm creepage and clearance distances
- AC coils & DC coils
- Cadmium Free option available

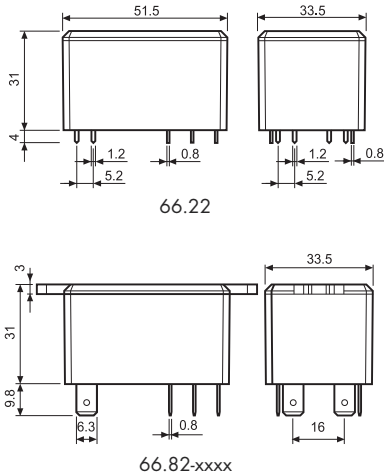

FOR UL HORSEPOWER AND PILOT DUTY RATINGS
SEE "General technical information" page V

Contact specification

Contact configuration	2 CO (DPDT)	2 CO (DPDT)
Rated current/Maximum peak current	A 30/50 (NO) - 10/20 (NC)	30/50 (NO) - 10/20 (NC)
Rated voltage/Maximum switching voltage V AC	250/440	250/440
Rated load AC1	VA 7,500 (NO) - 2,500 (NC)	7,500 (NO) - 2,500 (NC)
Rated load AC15 (230 V AC)	VA 1,200 (NO)	1,200 (NO)
Single phase motor rating (230 V AC)	kW 1.5 (NO)	1.5 (NO)
Breaking capacity DC1: 30/110/220 V	A 25/0.7/0.3 (NO)	25/0.7/0.3 (NO)
Minimum switching load	mW (V/mA) 1,000 (10/10)	1,000 (10/10)
Standard contact material	AgCdO	AgCdO

Coil specification

Nominal voltage (U _N)	V AC (50/60 Hz)	6 - 12 - 24 - 110/115 - 120/125 - 230 - 240
	V DC	6 - 12 - 24 - 110 - 125
Rated power AC/DC	VA (50 Hz)/W	3.6/1.7
Operating range	AC	(0.8...1.1)U _N
	DC	(0.8...1.1)U _N
Holding voltage	AC/DC	0.8 U _N /0.5 U _N
Must drop-out voltage	AC/DC	0.2 U _N /0.1 U _N

Technical data

Mechanical life AC/DC	cycles	10 · 10 ⁶	10 · 10 ⁶
Electrical life at rated load AC1	cycles	100 · 10 ³	100 · 10 ³
Operate/release time	ms	8/15	8/15
Insulation between coil and contacts (1.2/50 μs)	kV	6 (8 mm)	6 (8 mm)
Dielectric strength between open contacts	V AC	1,500	1,500
Ambient temperature range	°C	-40...+70	-40...+70
Environmental protection		RT II	RT II

Approvals (according to type)

66.22



- 30 A rated contacts
- PCB mount - bifurcated terminals

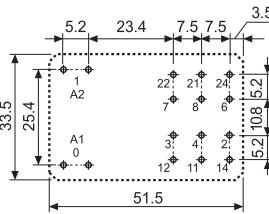
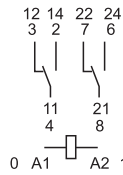

Copper side view

66.82



- 30 A rated contacts
- Flange mount
- Faston 250 connections

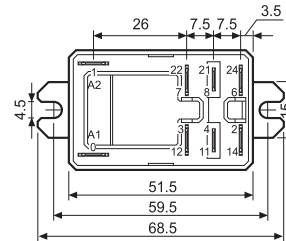
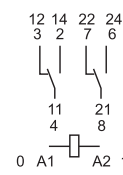

Features

2 Pole NO (DPST-NO)
30 A Power relay

66.22-x300 PCB mount
66.82-x300 Faston 250 connections - Flange mount

- Reinforced insulation between coil and contacts according to EN 60335-1; 8 mm creepage and clearance distances
- AC coils & DC coils
- Cadmium Free option available

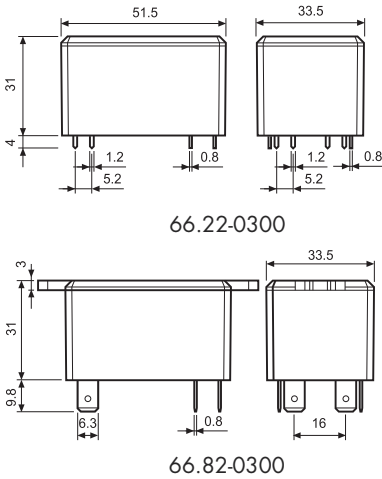

FOR UL HORSEPOWER AND PILOT DUTY RATINGS
SEE "General technical information" page V

66.22-x300



- 30 A rated contacts
- PCB mount - bifurcated terminals

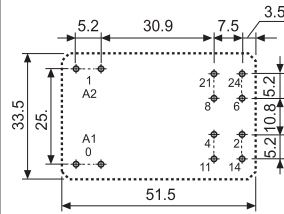
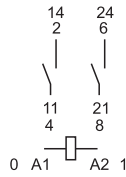

Copper side view

66.82-x300



- 30 A rated contacts
- Flange mount
- Faston 250 connections

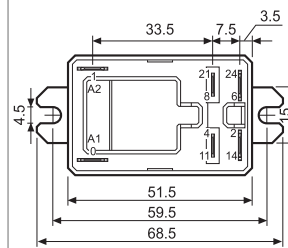
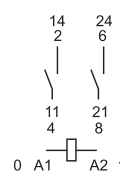

Contact specification

Contact configuration		2 NO (DPST-NO)	2 NO (DPST-NO)
Rated current/Maximum peak current	A	30/50	30/50
Rated voltage/Maximum switching voltage	V AC	250/440	250/440
Rated load AC1	VA	7,500	7,500
Rated load AC15 (230 V AC)	VA	1,200	1,200
Single phase motor rating (230 V AC)	kW	1.5	1.5
Breaking capacity DC1: 30/110/220 V	A	25/0.7/0.3	25/0.7/0.3
Minimum switching load	mW (V/mA)	1,000 (10/10)	1,000 (10/10)
Standard contact material		AgCdO	AgCdO

Coil specification

Nominal voltage (U_N)	V AC (50/60 Hz)	6 - 12 - 24 - 110/115 - 120/125 - 230 - 240
	V DC	6 - 12 - 24 - 110 - 125
Rated power AC/DC	VA (50 Hz)/W	3.6/1.7
Operating range	AC	$(0.8 \dots 1.1) U_N$
	DC	$(0.8 \dots 1.1) U_N$
Holding voltage	AC/DC	$0.8 U_N / 0.5 U_N$
Must drop-out voltage	AC/DC	$0.2 U_N / 0.1 U_N$

Technical data

Mechanical life AC/DC	cycles	$10 \cdot 10^6$	$10 \cdot 10^6$
Electrical life at rated load AC1	cycles	$100 \cdot 10^3$	$100 \cdot 10^3$
Operate/release time	ms	8/10	8/10
Insulation between coil and contacts (1.2/50 μ s)	kV	6 (8 mm)	6 (8 mm)
Dielectric strength between open contacts	V AC	1,500	1,500
Ambient temperature range	$^{\circ}$ C	-40...+70	-40...+70
Environmental protection		RT II	RT II

Approvals (according to type)



Ordering information

Example: 66 series relay, Faston 250 (6.3x0.8 mm) with top flange mount, 2 CO (DPDT) 30 A contacts, 24 V DC coil.

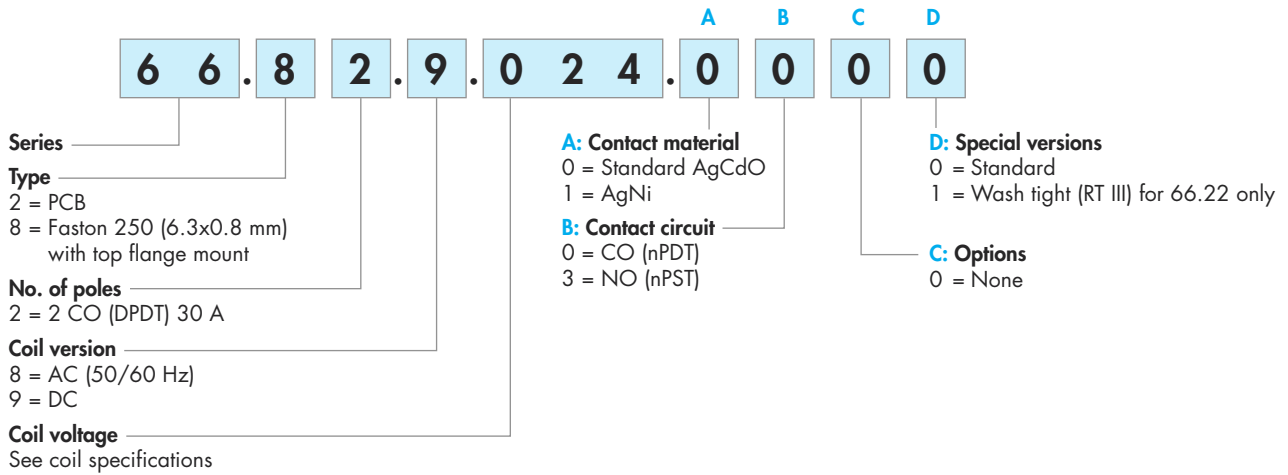

Selecting features and options: only combinations in the same row are possible.
Preferred selections for best availability are shown in **bold**.

Type	Coil version	A	B	C	D
66.22	AC-DC	0 - 1	0 - 3	0	0 - 1
66.82	AC-DC	0 - 1	0 - 3	0	0

Technical data

Insulation according to EN 61810-1			
Nominal voltage of supply system	V AC	230/400	
Rated insulation voltage	V AC	400	
Pollution degree		3	
Insulation between coil and contact set			
Type of insulation		Reinforced (8 mm)	
Overtoltage category		III	
Rated impulse voltage	kV (1.2/50 µs)	6	
Dielectric strength	V AC	4,000	
Insulation between adjacent contacts			
Type of insulation		Basic	
Overtoltage category		III	
Rated impulse voltage	kV (1.2/50 µs)	4	
Dielectric strength	V AC	2,500	
Insulation between open contacts			
Type of disconnection		Micro-disconnection	
Dielectric strength	V AC/kV (1.2/50 µs)	1,500/2	
Conducted disturbance immunity			
Burst (5...50)ns, 5 kHz, on A1 - A2	EN 61000-4-4	level 4 (4 kV)	
Surge (1.2/50 µs) on A1 - A2 (differential mode)	EN 61000-4-5	level 4 (4 kV)	
Other data			
Bounce time: NO/NC	ms	7/10	
Vibration resistance (10...150)Hz: NO/NC	g	20/19	
Shock resistance	g	20	
Power lost to the environment	without contact current	W	2.3
	with rated current	W	5
Recommended distance between relays mounted on PCB	mm	≥ 10	

Contact specification

F 66 - Electrical life (AC) v contact current
250 V (normally open contact)

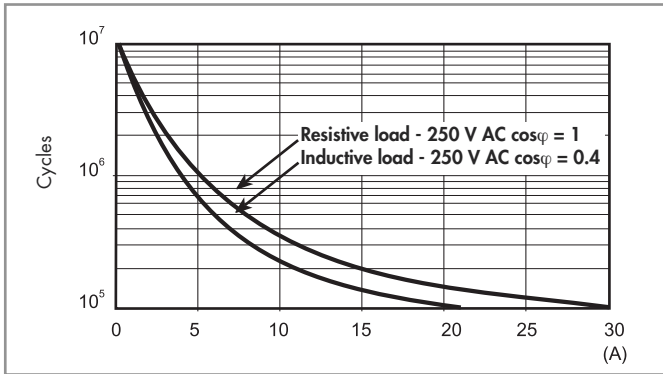

F 66 - Electrical life (AC) v contact current
440 V (normally open contact)

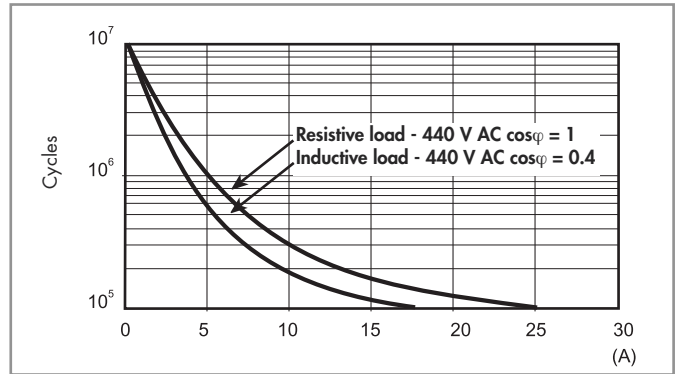

H 66 - Maximum DC1 breaking capacity

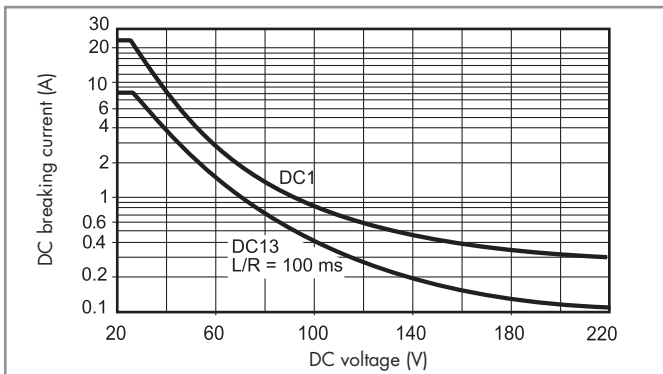

- When switching a resistive load (DC1) having voltage and current values under the curve, an electrical life of $\geq 100 \cdot 10^3$ can be expected.
- In the case of DC13 loads, the connection of a diode in parallel with the load will permit a similar electrical life as for a DC1 load. Note: the release time for the load will be increased.

Coil specifications

DC coil data

Nominal voltage U_N V	Coil code	Operating range		Resistance R Ω	Rated coil consumption I at U_N mA
		U_{min} V	U_{max} V		
6	9.006	4.8	6.6	21	283
12	9.012	9.6	13.2	85	141
24	9.024	19.2	26.4	340	70.5
110	9.110	88	121	7,000	15.7
125	9.125	100	138	9,200	13.6

AC coil data

Nominal voltage U_N V	Coil code	Operating range		Resistance R Ω	Rated coil consumption I at U_N (50Hz) mA
		U_{min} V	U_{max} V		
6	8.006	4.8	6.6	3	600
12	8.012	9.6	13.2	11	300
24	8.024	19.2	26.4	50	150
110/115	8.110	88	126	930	32.6
120/125	8.120	96	137	1,050	30
230	8.230	184	253	4,000	15.7
240	8.240	192	264	5,500	15

R 66 - DC coil operating range v ambient temperature

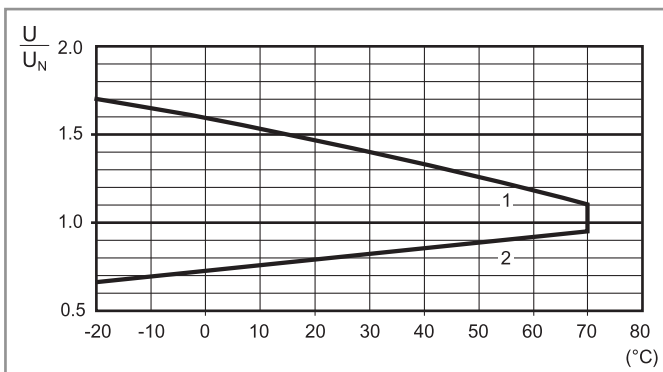

- 1 - Max. permitted coil voltage.
- 2 - Min. pick-up voltage with coil at ambient temperature.

R 66 - AC coil operating range v ambient temperature

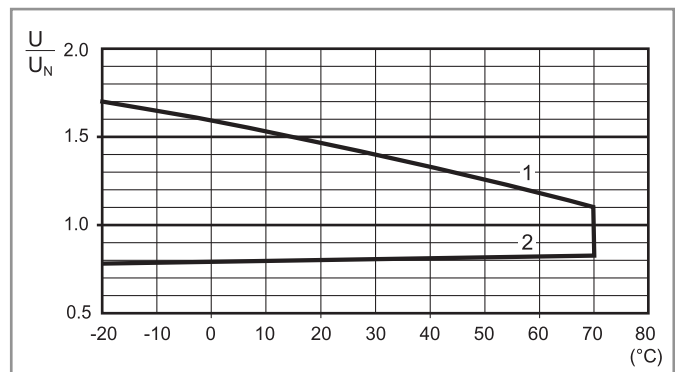

- 1 - Max. permitted coil voltage.
- 2 - Min. pick-up voltage with coil at ambient temperature.

Accessories

Top 35 mm rail (EN 60715) mount for types 66.82.xxxx.0x00 | 066.07



066.07



066.07 with relay

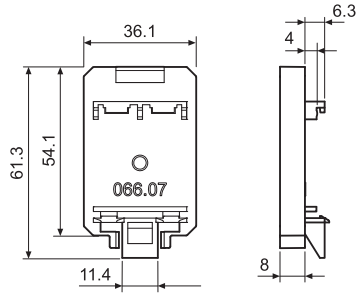

066.07

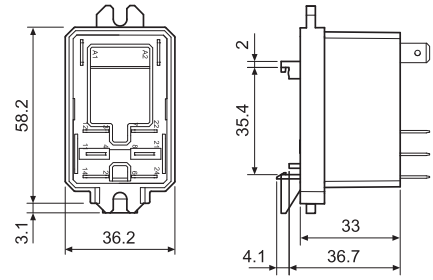

066.07 with relay

