



Winstar Display Co., LTD

華凌光電股份有限公司

WEB: <http://www.winstar.com.tw>

E-mail: winstar@winstar.com.tw



SPECIFICATION

CUSTOMER : _____

MODULE NO.: WF70GTIAGDNT0#

<p align="center">APPROVED BY:</p> <p>(FOR CUSTOMER USE ONLY)</p>	<p>PCB VERSION: _____</p> <p>DATA: _____</p>
--	--

SALES BY	APPROVED BY	CHECKED BY	PREPARED BY
			葉虹蘭
ISSUED DATE: 2014/04/17			

TFT Display Inspection Specification: <http://www.winstar.com.tw/service.php>

RECORDS OF REVISION

DOC. FIRST ISSUE

VERSION	DATE	REVISED PAGE NO.	SUMMARY
0	2013/09/05		First issue
A	2013/12/13		Modify the Contour Drawing
B	2014/04/17		Modify Package Specification. Correct Electrical Characteristics.

Contents

- 1.Module Classification Information
- 2.Summary
- 3.General Specification
- 4.Absolute Maximum Ratings
- 5.Electrical Characteristics
- 6.DC Characteristics
- 7.AC Characteristics
- 8.Optical Characteristics
- 9.Interface
- 10.Block Diagram
- 11.Reliability
- 12.Touch Panel Information
- 13.Contour Drawing
- 14.Package Specification
- 15.Other

1. Module Classification Information

W	F	70	G	T	I	A	G	D	N	T	0	#
①	②	③	④	⑤	⑥	⑦	⑧	⑨	⑩	⑪	⑫	⑬

①	Brand : WINSTAR DISPLAY CORPORATION												
②	Display Type : F→TFT Type, J→Custom TFT												
③	Display Size : 7.0" TFT												
④	Model serials no.												
⑤	Backlight Type :	F→CCFL, White S→LED, High Light White						T→LED, White					
⑥	LCD Polarize Type/ Temperature range/ Gray Scale Inversion Direction	I→Transmissive, W. T, 6:00 L→Transmissive, W.T,12:00 Z→Transmissive, W.T, Wide Viewing Angle for O-FILM Y→Transmissive, W.T, Wide View											
⑦	A : TFT LCD B : TFT+FR+CONTROL BOARD C : TFT+FR+A/D BOARD D : TFT+FR+A/D BOARD+CONTROL BOARD E : TFT+FR+POWER BOARD F : TFT+CONTROL BOARD						G : TFT+FR H : TFT+D/V BOARD I : TFT+FR+D/V BOARD J : TFT+POWER BD						
⑧	Solution:												
	A: 128160	B:320234	C:320240	D:480234	E:480272	F: 640480	G: 800480						
	H:1024600	I:320480	J:240320	K:800600	L:240400	M :1024768	P :1280800						
⑨	D: Digital L : LVDS												
⑩	Interface : N : without control board A : 8Bit B : 16Bit												
⑪	TS : N : Without TS T : resistive touch panel C : capacitive touch panel												
⑫	Version												
⑬	Special Code	#:Fit in with ROHS directive regulations											

2.Summary

This technical specification applies to 7.0' color TFT-LCD panel. The 7.0' color TFT-LCD panel is designed for camcorder, digital camera application and other electronic products which require high quality flat panel displays. This module follows RoHS.

3. General Specifications

Item	Dimension	Unit
Dot Matrix	800 x RGBx480(TFT)	dots
Module dimension	165.0(W) x 100(H) x 7.0(D)	mm
Active area	154.08 x 85.92	mm
Dot pitch	0.0642 x 0.179	mm
LCD type	TFT, Normally White, Transmissive	
View Direction	12 o'clock	
Gray Scale Inversion Direction	6 o'clock	
Backlight Type	LED, Normally White	

*Color tone slight changed by temperature and driving voltage.

4. Absolute Maximum Ratings

Item	Symbol	Min	Typ	Max	Unit
Operating Temperature	TOP	-20	—	+70	°C
Storage Temperature	TST	-30	—	+80	°C

Note: Device is subject to be damaged permanently if stresses beyond those absolute maximum ratings listed above

1. Temp. $\leq 60^{\circ}\text{C}$, 90% RH MAX. Temp. $> 60^{\circ}\text{C}$, Absolute humidity shall be less than 90% RH at 60°C

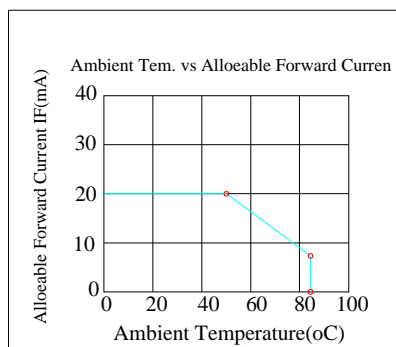

5. Electrical Characteristics

5.1. Operating conditions:

Item	Symbol	Min	Typ	Max	Unit	Remark
Supply Voltage For Logic	VCC	3.0	3.3	3.6	V	Note 2
Power Supply For Current	VCC =3.3V		4	10	mA	
Power Consumption	VCC =3.3V		13.2	36	mW	
Power voltage	AVDD	10.2	10.4	10.6	V	
Power voltage	VGH	15.3	16.0	16.7	V	
Power voltage	VGL	-7.7	-7.0	-6.3	V	
Input signal voltage	VCOM	2.6	(3.6)	4.6	V	Note 4

Note 1: Be sure to apply VCC and VGL to the LCD first, and then apply VGH.

Note 2: VCC setting should match the signals output voltage (refer to Note 3) of customer's system board.

Note 3: DCLK,HS,VS,RESET,U/D, L/R,DE,R0~R7,G0~G7,B0~B7,MODE,DITHB.

Note 4: Typical VCOM is only a reference value. It must be optimized according to each LCM. Please use VR and base on below application circuit.

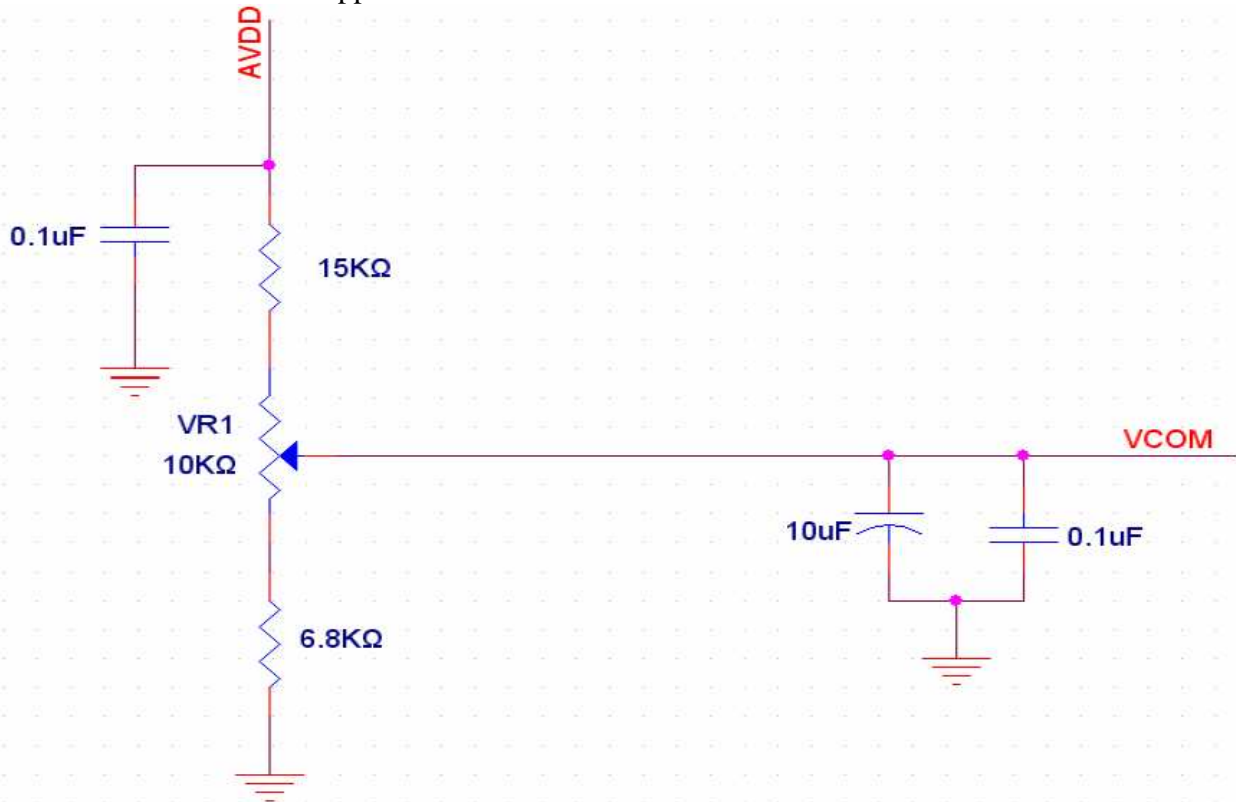

5.2. LED driving conditions

Parameter	Symbol	Min.	Typ.	Max.	Unit	Remark
LED current	-	-	180	-	mA	-
Power Consumption	-	1620	-	1890	mW	-
LED voltage	A~K	9.0	-	10.5	V	Note 1
LED Life Time	-	-	50,000	-	Hr	Note 2,3,4

Note 1 : There are 1 Groups LED

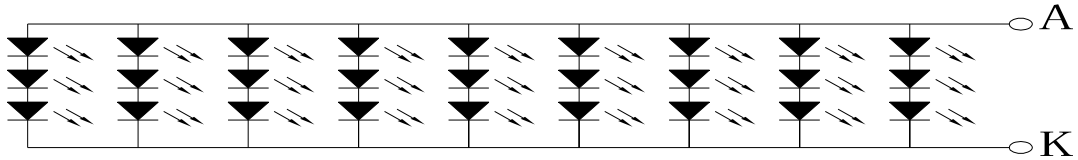

Backlight LED Circuit

Note 2 : $T_a = 25\text{ }^\circ\text{C}$

Note 3 : Brightness to be decreased to 50% of the initial value

Note 4 : The single LED lamp case

6.DC CHARATERISTICS

Parameter	Symbol	Rating			Unit	Condition
		Min	Typ	Max		
Low level input voltage	V_{IL}	0	-	0.3VCC	V	
High level input voltage	V_{IH}	0.7VCC	-	VCC	V	

7.AC CHARATERISTICS

7.1. Parallel DE mode RGB input timing table

Signal	Symbol	Min	Typ	Max	Unit
HS setup time	Thst	8	-	-	ns
HS hold time	Thhd	8	-	-	ns
VS setup time	Tvst	8	-	-	ns
VS hold time	Tvhd	8	-	-	ns
Data setup time	Tdsu	8	-	-	ns
Data hole time	Tdhd	8	-	-	ns
DE setup time	Tesu	8	-	-	ns
DE hole time	Tehd	8	-	-	ns
VCC Power On Slew rate	TPOR	-	-	20	ms
RESET pulse width	TRst	1	-	-	ms
DCLK cycle time	Tcoh	20	-	-	ns
DCLK pulse duty	Tcwh	40	50	60	%

7.2. Input Clock and Data Timing Diagram

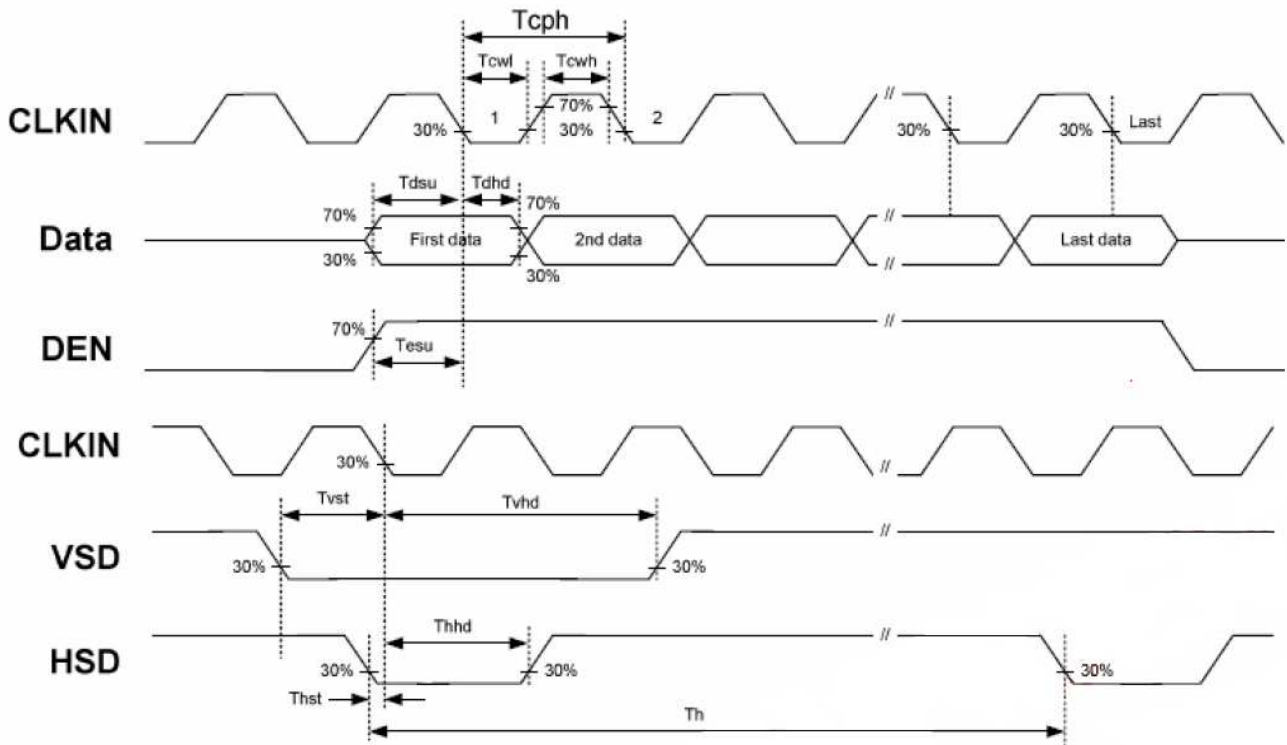

7.3. Timing

Item	Symbol	Values			Unit	Remark
		Min.	Typ.	Max.		
Horizontal Display Area	thd	-	800	-	DCLK	
DCLK Frequency	fclk	26.4	33.3	46.8	MHz	
One Horizontal Line	th	862	1056	1200	DCLK	
HS pulse width	thpw	1	-	40	DCLK	
HS Blanking	thb	46	46	46	DCLK	
HS Front Porch	thfp	16	210	354	DCLK	

Item	Symbol	Values			Unit	Remark
		Min.	Typ.	Max.		
Vertical Display Area	tvd	-	480	-	TH	
VS period time	tv	510	525	650	TH	
VS pulse width	tvpw	1	-	20	TH	
VS Blanking	tvb	23	23	23	TH	
VS Front Porch	tvfp	7	22	147	TH	

7.4. Data Input Format

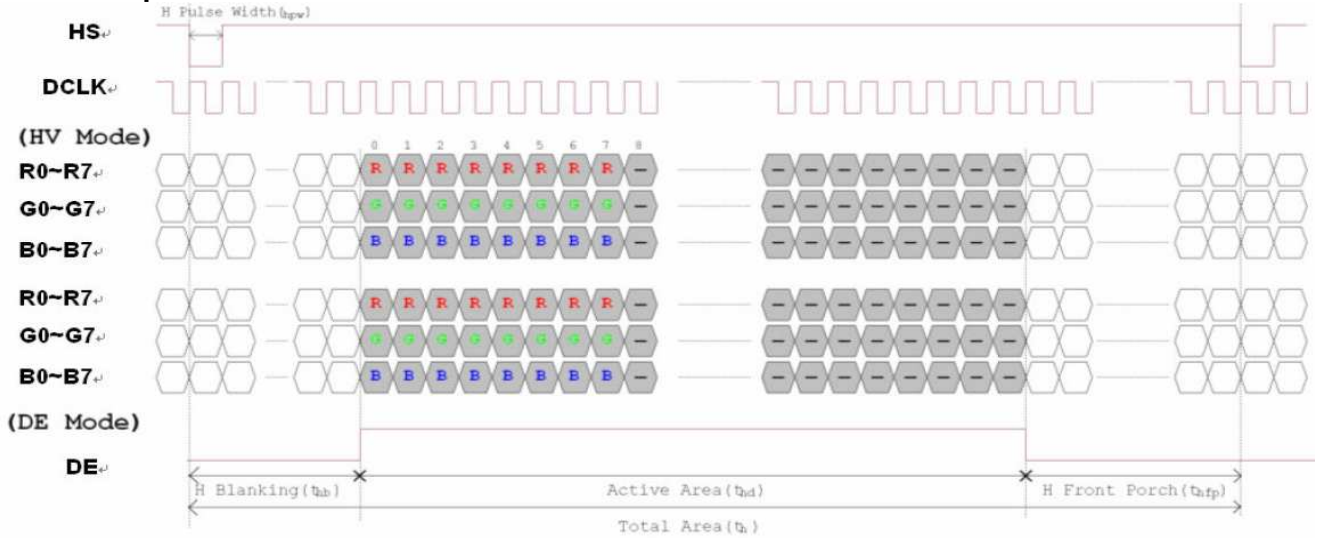

Fig. Horizontal input timing diagram

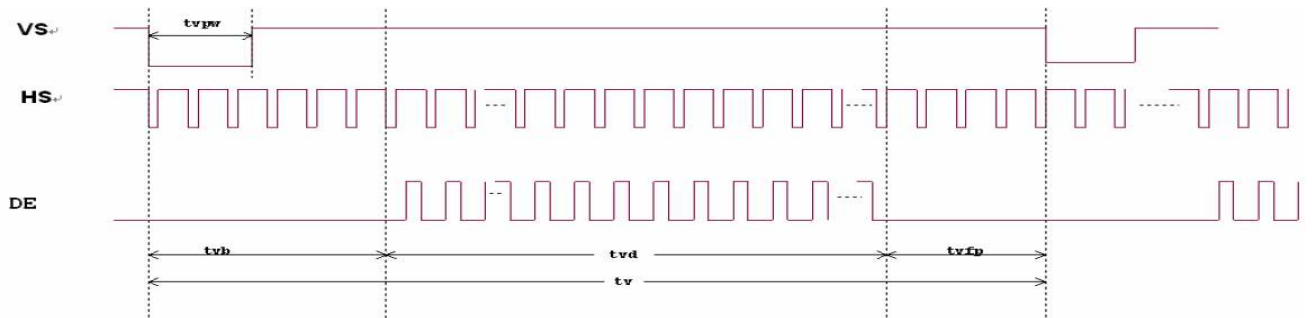

Fig. Vertical input timing diagram

8. Optical Characteristics

Item	Symbol	Condition.	Min	Typ.	Max.	Unit	Remark	
Response time	Tr	$\theta=0^\circ$ 、 $\Phi=0^\circ$	-	10	20	.ms	Note 3	
	Tf		-	15	30	.ms		
Contrast ratio	CR	At optimized viewing angle	400	500	-	-	Note 4	
Color Chromaticity	White	$\theta=0^\circ$ 、 $\Phi=0^\circ$	Wx	0.26	0.31	0.36	-	Note 2,5,6
			Wy	0.28	0.33	0.38	-	
Viewing angle	Hor.	$CR \geq 10$	Θ_R	60	70	-	Deg.	Note 1
			Θ_L	60	70	-		
	Ver.		Φ_T	40	50	-		
			Φ_B	60	70	-		
Brightness	-	-	240	320	-	cd/m ²	Center of display	

Ta=25±2°C, IL=180mA

Note 1: Definition of viewing angle range

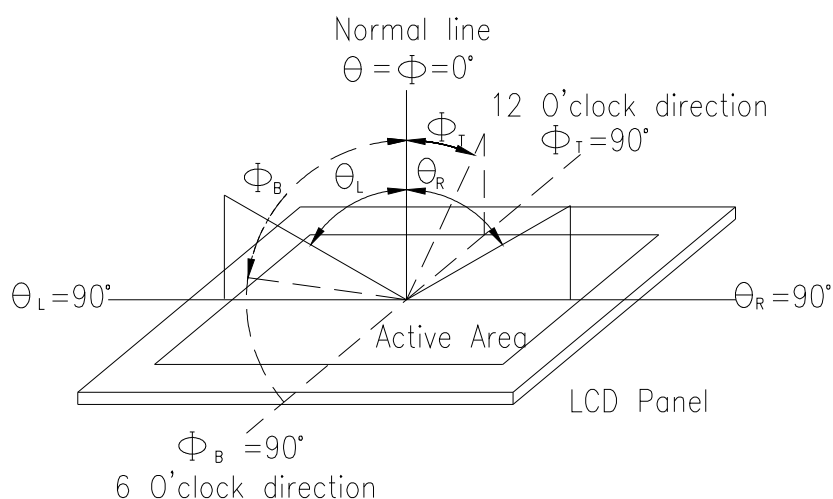

Fig. 8.1. Definition of viewing angle

Note 2: Test equipment setup:

After stabilizing and leaving the panel alone at a driven temperature for 10 minutes, the measurement should be executed. Measurement should be executed in a stable, windless, and dark room. Optical specifications are measured by Topcon BM-7orBM-5 luminance meter 1.0° field of view at a distance of 50cm and normal direction.

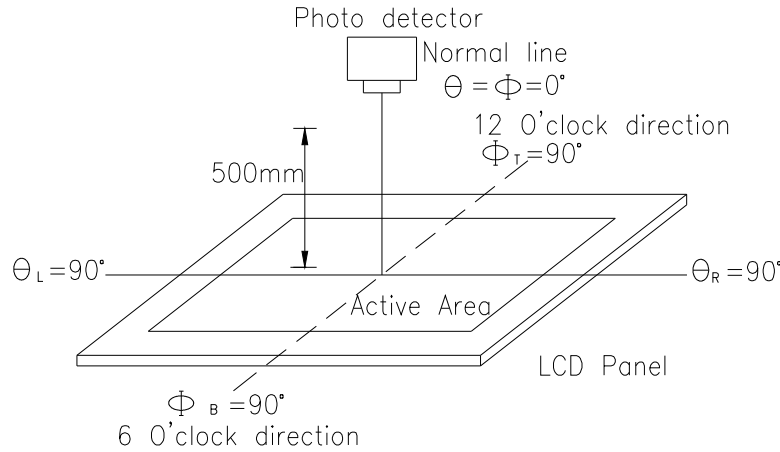
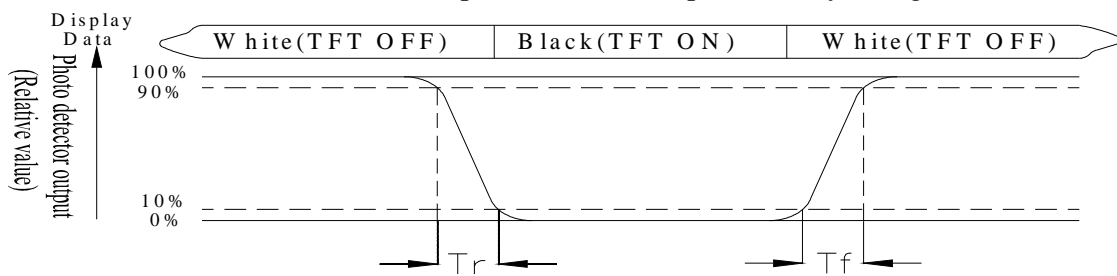

Fig. 8.2. Optical measurement system setup

Note 3: Definition of Response time:

The response time is defined as the LCD optical switching time interval between “White” state and “Black” state. Rise time, T_r , is the time between photo detector output intensity changed from 90% to 10%. And fall time, T_f , is the time between photo detector output intensity changed from 10% to 90%



Note 4: Definition of contrast ratio:

The contrast ratio is defined as the following expression.

$$\text{Contrast ratio (CR)} = \frac{\text{Luminance measured when LCD on the "White" state}}{\text{Luminance measured when LCD on the "Black" state}}$$

Note 5: White $V_i = V_{i50} \pm 1.5V$

Black $V_i = V_{i50} \pm 2.0V$

“±” means that the analog input signal swings in phase with VCOM signal.

“±” means that the analog input signal swings out of phase with VCOM signal.

The 100% transmission is defined as the transmission of LCD panel when all the input terminals of module are electrically opened.

Note 6: Definition of color chromaticity (CIE 1931)

Color coordinates measured at the center point of LCD

Note 7: Measured at the center area of the panel when all the input terminals of LCD panel are electrically opened.

$$\text{Note 8: Uniformity (U)} = \frac{\text{Brightness (min)}}{\text{Brightness (max)}} \times 100\%$$

9.Interface

9.1. LCM PIN Definition

Pin	Symbol	Function	Remark
1	A	Power supply for backlight	
2	A	Power supply for backlight	
3	K	Backlight ground	
4	K	Backlight ground	
5	GND	Power ground	
6	VCOM	Common voltage	
7	VCC	Power for Digital Circuit	
8	MODE	DE/SYNC mode select	Note 1
9	DE	Data Input Enable	
10	VS	Vertical Sync Input	
11	HS	Horizontal Sync Input	
12	B7	Blue data(MSB)	
13	B6	Blue data	
14	B5	Blue data	
15	B4	Blue data	
16	B3	Blue data	
17	B2	Blue data	
18	B1	Blue data	Note 2
19	B0	Blue data(LSB)	Note 2
20	G7	Green data(MSB)	
21	G6	Green data	
22	G5	Green data	
23	G4	Green data	
24	G3	Green data	
25	G2	Green data	
26	G1	Green data	Note 2
27	G0	Green data(LSB)	Note 2
28	R7	Red data(MSB)	
29	R6	Red data	
30	R5	Red data	
31	R4	Red data	
32	R3	Red data	
33	R2	Red data	
34	R1	Red data	Note 2
35	R0	Red data(LSB)	Note 2
36	GND	Power Ground	
37	DCLK	Sample clock	Note 3
38	GND	Power Ground	
39	L/R	Left / right selection	Note 4,5
40	U/D	Up/down selection	Note 4,5
41	VGH	Gate ON Voltage	
42	VGL	Gate OFF Voltage	
43	AVDD	Power for Analog Circuit	
44	RESET	Global reset pin.	Note 6
45	NC	No connection	

46	VCOM	Common Voltage	
47	DITHB	Dithering function	Note 7
48	GND	Power Ground	
49	NC	No connection	
50	NC	No connection	

I: input, O: output, P: Power

Note 1: DE/SYNC mode select. Normally pull high.

When select DE mode, MODE="1", VS and HS must pull high.

When select SYNC mode, MODE="0", DE must be grounded.

Note 2: When input 18 bits RGB data, the two low bits of R,G and B data must be grounded.

Note 3: Data shall be latched at the falling edge of DCLK.

Note 4: Selection of scanning mode

Setting of scan control		Scanning direction
U/D	L/R	
GND	VCC	Up to down, left to right
VCC	GND	Down to up, right to left
GND	GND	Up to down, right to left
VCC	VCC	Down to up, left to right

Note 5: Definition of scanning direction.

Refer to the figure as below:

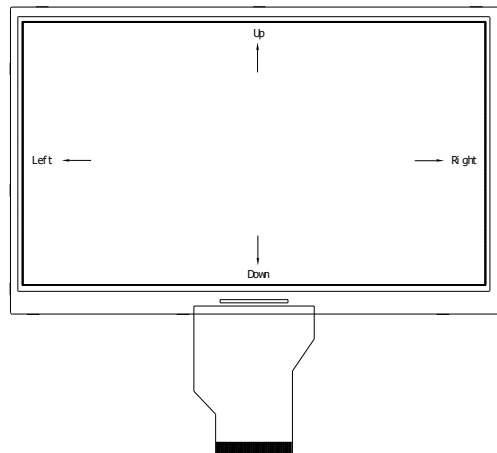

Note 6: Global reset pin. Active low to enter reset state . Suggest to connect with an RC reset circuit for stability. Normally pull high.

Note 7: Dithering function enable control, normally pull high.

When DITHB="1", Disable internal dithering function,

When DITHB="0", Enable internal dithering function,

10. Block Diagram

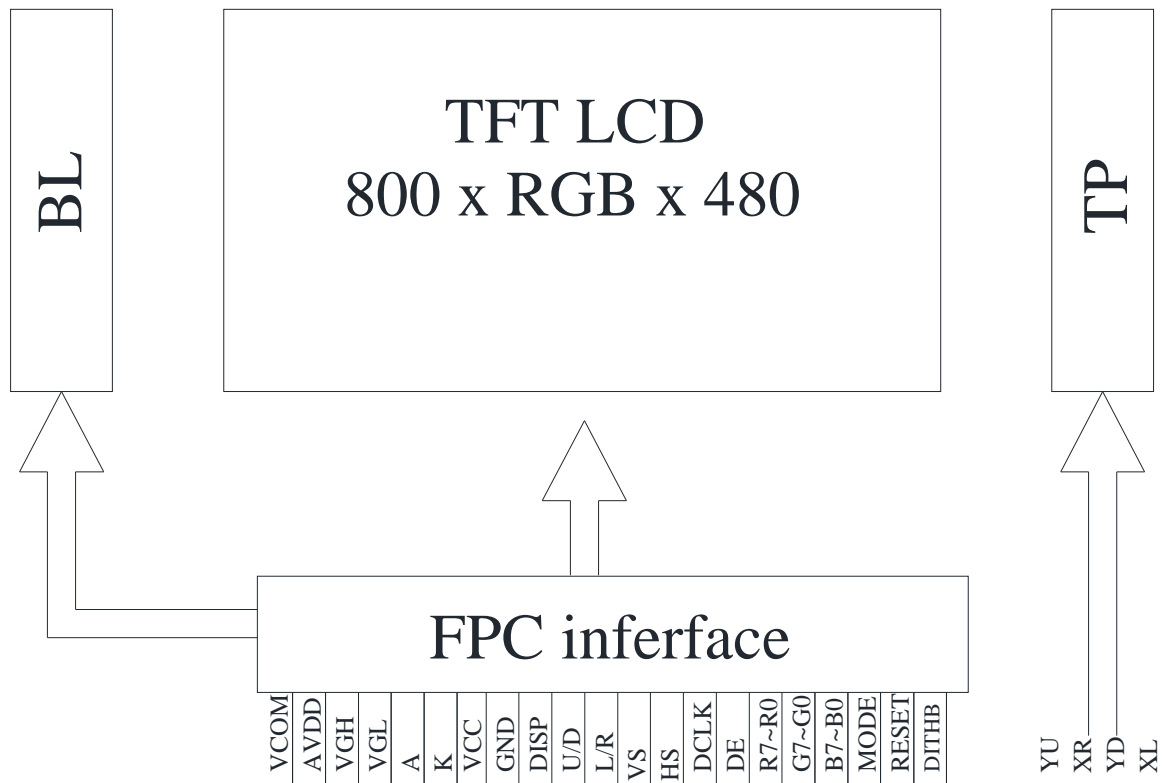

11. Reliability

Content of Reliability Test (Wide temperature, -20°C~70°C)

Environmental Test			
Test Item	Content of Test	Test Condition	Note
High Temperature storage	Endurance test applying the high storage temperature for a long time.	80°C 200hrs	2
Low Temperature storage	Endurance test applying the high storage temperature for a long time.	-30°C 200hrs	1,2
High Temperature Operation	Endurance test applying the electric stress (Voltage & Current) and the thermal stress to the element for a long time.	70°C 200hrs	—
Low Temperature Operation	Endurance test applying the electric stress under low temperature for a long time.	-20°C 200hrs	1
High Temperature/ Humidity Operation	The module should be allowed to stand at 60 °C,90%RH max For 96hrs under no-load condition excluding the polarizer, Then taking it out and drying it at normal temperature.	60°C,90%RH 96hrs	1,2
Thermal shock resistance	The sample should be allowed stand the following 10 cycles of operation <div style="text-align: center;"> <p style="text-align: center;">-20°C 25°C 70°C</p> <p style="text-align: center;">30min ← 5min → 30min</p> <p style="text-align: center;">1 cycle</p> </div>	-20°C/70°C 10 cycles	—
Vibration test	Endurance test applying the vibration during transportation and using.	Total fixed amplitude : 15mm Vibration Frequency : 10~55Hz One cycle 60 seconds to 3 directions of X,Y,Z for Each 15 minutes	3
Static electricity test	Endurance test applying the electric stress to the terminal.	VS=800V, RS=1.5kΩ CS=100pF 1 time	—

Note1: No dew condensation to be observed.

Note2: The function test shall be conducted after 4 hours storage at the normal Temperature and humidity after remove from the test chamber.

Note3: Vibration test will be conducted to the product itself without putting it in a container.

12.Touch Panel Information

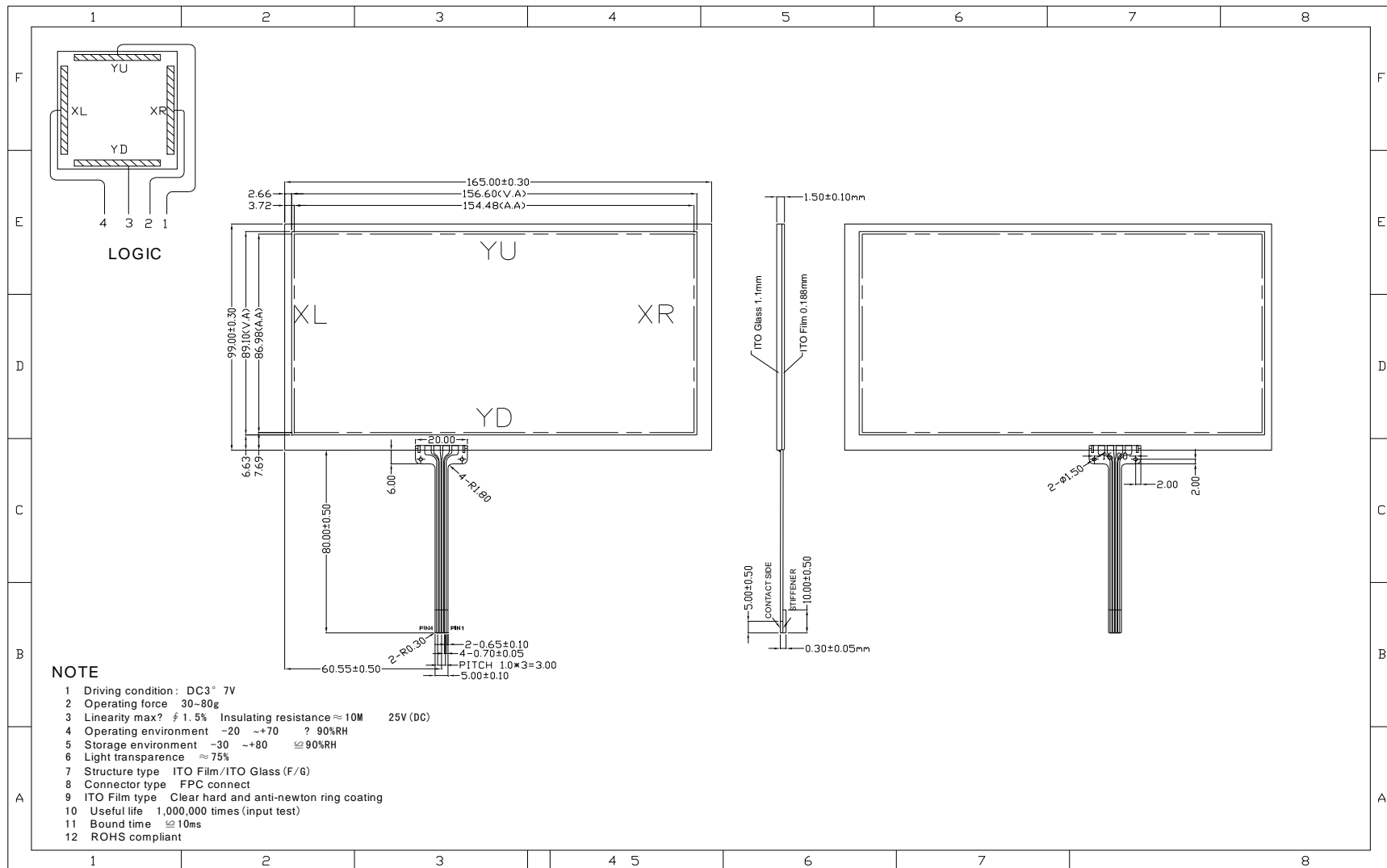

13. Contour Drawing

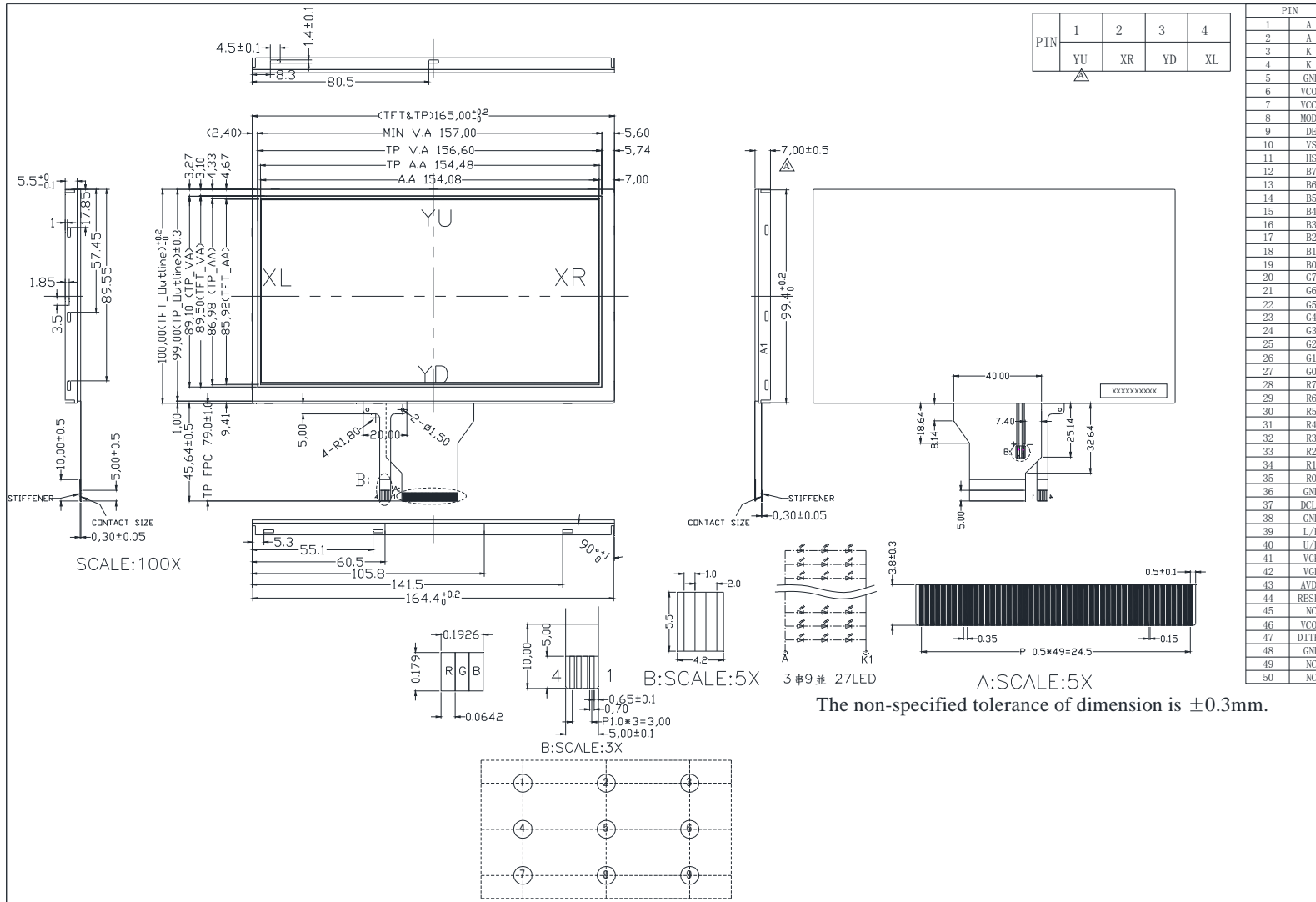

14.PACKAGE SPECIFICATION

LCM Model	WF70GTIAGDNT0#	<h2 style="margin: 0;">LCM 包裝規格書</h2> <h3 style="margin: 5px 0 0 0;">LCM Packaging Specifications</h3>	Approve	Check	Contact
Drawing NO.			DATE	初版	版次 Ver
			14'02/19	13'00/05	A

1.包裝材料規格表 (Packaging Material) :(per carton)

NO.	Item	Model	Dimensions	Quantity
1	成品 (LCM)	WF70GTIAGDNT0#		60
2	TRAY 盤 (2)	PKCA1XXXXXXXXXXXX0354	315mm*265mm	30
3	BP01 內盒(3)Product Box	PK3Y1XXXXXXXXXXXX0001	332*280*100mm	6
4	泡棉(4)Foam	-----		6
5	外紙箱(5)Carton	PK4X1XXXXXXXXXXXX0000	565*340*320mm	1
6				
7				
8				
9				

2.單箱數量規格表(Packaging Specifications and Quantity) :

(1)LCM quantity per box : no per tray 2 x no of tray 5 =10

(2)Total LCM quantity in carton : quantity per box 10 x no of boxes 6 =60

特 記 事 項 (REMARK)

<p>1. Label Specifications :</p> <div style="border: 1px solid black; padding: 5px; margin-top: 5px;"> MOOEL: LOT NO : QUANTITY: CHECK: </div>	
---	--

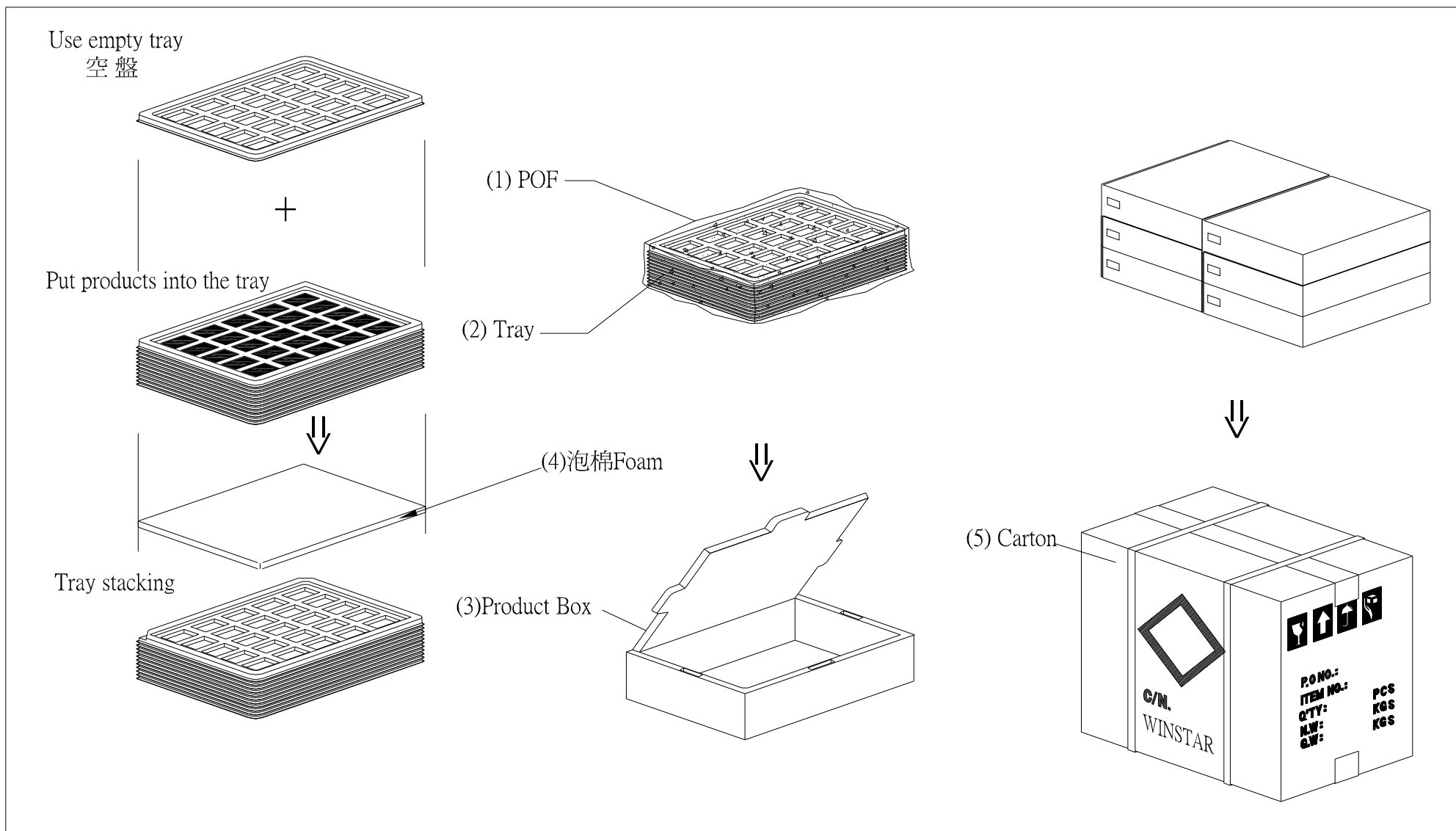



1、Panel Specification :

- 1. Panel Type : Pass NG , _____
- 2. View Direction : Pass NG , _____
- 3. Numbers of Dots : Pass NG , _____
- 4. View Area : Pass NG , _____
- 5. Active Area : Pass NG , _____
- 6. Operating Temperature : Pass NG , _____
- 7. Storage Temperature : Pass NG , _____
- 8. Others : _____

2、Mechanical Specification :

- 1. PCB Size : Pass NG , _____
- 2. Frame Size : Pass NG , _____
- 3. Material of Frame : Pass NG , _____
- 4. Connector Position : Pass NG , _____
- 5. Fix Hole Position : Pass NG , _____
- 6. Backlight Position : Pass NG , _____
- 7. Thickness of PCB : Pass NG , _____
- 8. Height of Frame to PCB : Pass NG , _____
- 9. Height of Module : Pass NG , _____
- 10. Others : Pass NG , _____

3、Relative Hole Size :

- 1. Pitch of Connector : Pass NG , _____
- 2. Hole size of Connector : Pass NG , _____
- 3. Mounting Hole size : Pass NG , _____
- 4. Mounting Hole Type : Pass NG , _____
- 5. Others : Pass NG , _____

4、Backlight Specification :

- 1. B/L Type : Pass NG , _____
- 2. B/L Color : Pass NG , _____
- 3. B/L Driving Voltage (Reference for LED Type) : Pass NG , _____
- 4. B/L Driving Current : Pass NG , _____
- 5. Brightness of B/L : Pass NG , _____
- 6. B/L Solder Method : Pass NG , _____
- 7. Others : Pass NG , _____

>> **Go to page 2** <<



Winstar Module Number : _____

Page: 2

5、Electronic Characteristics of Module :

- | | | | |
|------------------------------|-------------------------------|-------------------------------|-------|
| 1. Input Voltage : | <input type="checkbox"/> Pass | <input type="checkbox"/> NG , | _____ |
| 2. Supply Current : | <input type="checkbox"/> Pass | <input type="checkbox"/> NG , | _____ |
| 3. Driving Voltage for LCD : | <input type="checkbox"/> Pass | <input type="checkbox"/> NG , | _____ |
| 4. Contrast for LCD : | <input type="checkbox"/> Pass | <input type="checkbox"/> NG , | _____ |
| 5. B/L Driving Method : | <input type="checkbox"/> Pass | <input type="checkbox"/> NG , | _____ |
| 6. Negative Voltage Output : | <input type="checkbox"/> Pass | <input type="checkbox"/> NG , | _____ |
| 7. Interface Function : | <input type="checkbox"/> Pass | <input type="checkbox"/> NG , | _____ |
| 8. LCD Uniformity : | <input type="checkbox"/> Pass | <input type="checkbox"/> NG , | _____ |
| 9. ESD test : | <input type="checkbox"/> Pass | <input type="checkbox"/> NG , | _____ |
| 10. Others : | <input type="checkbox"/> Pass | <input type="checkbox"/> NG , | _____ |

6、Summary :

Sales signature : _____

Customer Signature : _____

Date : / / _____