

### SAFETY ORGANIZATIONS

THIS FILTER HAS BEEN FORMALLY RECOGNIZED, CERTIFIED OR APPROVED BY THE LISTED AGENCY. THEREFORE, ALL TEST/REQUIREMENTS SPECIFIED IN THE LATEST REVISION OF THE FOLLOWING AGENCY STANDARDS HAVE BEEN MET:

UL RECOGNIZED: UL 1283  
 CSA CERTIFIED: CSA 22.2, # 8  
 VDE APPROVED: EN 133200

### OPERATING SPECIFICATIONS

LINE CURRENT/VOLTAGE: 1 AMP/40°C, 120/250VAC

LINE FREQUENCY: 50-60Hz

MAXIMUM LEAKAGE CURRENT,  
 EACH LINE TO GROUND:  
 0.40mA @ 120V, 60Hz  
 0.70mA @ 250V, 50Hz

OPERATING AMBIENT TEMP. RANGE: -10°C TO +40°C @ RATED CURRENT,  $I_r$ .

IN AN AMBIENT,  $T_0$ , HIGHER THAN 40°C, THE MAXIMUM OPERATING CURRENT,  $I_0$ , IS AS FOLLOWS:

$$I_0 = I_r \sqrt{\frac{100 - T_0}{60}}$$

### RELIABILITY SPECIFICATIONS:

STORAGE TEMPERATURE: -40°C TO +85°C  
 HUMIDITY: 21 DAYS @ 40°C 95% RH.  
 CURRENT OVERLOAD TEST: 6 TIMES  $I_r$  FOR 8 SECONDS

### TEST SPECIFICATIONS:

INDUCTANCE: 1.86mH NOMINAL  
 CAPACITANCE: (MEASURED @ 1KHz, 0.250VAC MAX., 25°C±1°C)  
 LINE TO GROUND: 0.0089µF ±20%  
 LINE TO LINE: 0.012µF ±20%  
 DISCHARGE RESISTOR: 1.5MΩ  
 L/G AND L/L I.R.:  
 NO DISCHARGE RESISTOR: 6000MΩ (MIN.) @ 100VDC, 20°C AND 50% RH

### RECOMMENDED RECEIVING INSPECTION HIPOT:

LINE TO GROUND: 1500VAC OR 2250VDC FOR 1 MINUTE  
 LINE TO LINE: 1450VDC FOR 1 MINUTE

### FILTER APPROVAL:

THE BEST WAY TO SELECT AND QUALIFY A FILTER IS FOR YOUR ENGINEERING TO TEST THE UNIT IN YOUR EQUIPMENT.

CATALOG # 1VB1

ECD #	APPRVD.	DATE
	KAW	30NOV06

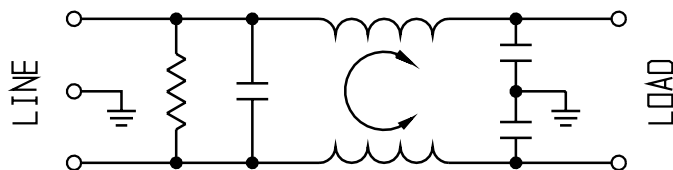
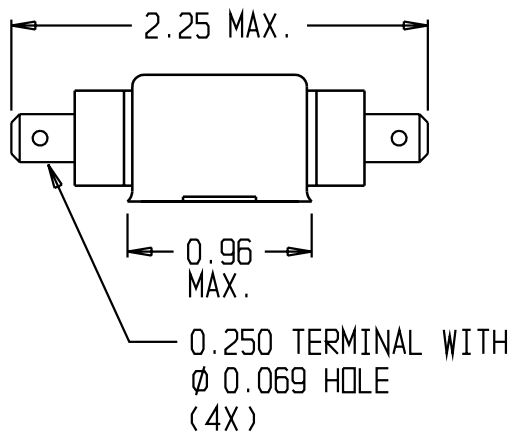
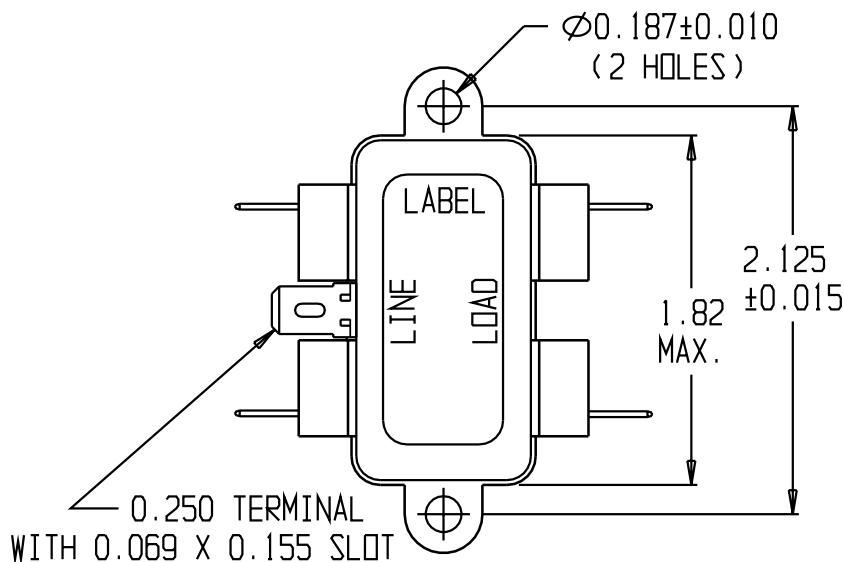
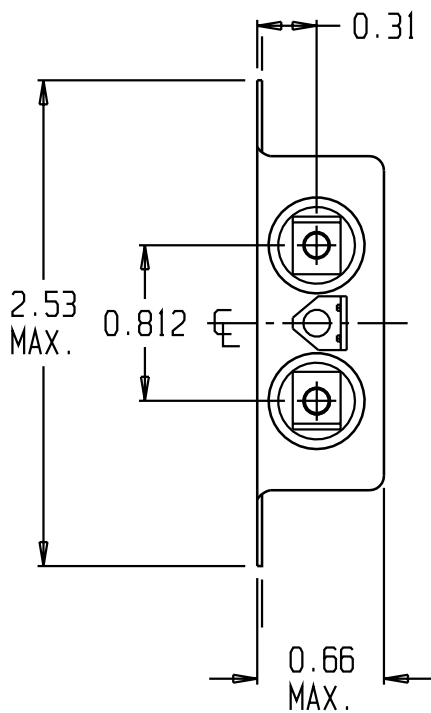

### 50Ω - 50Ω (MINIMUM) INSERTION LOSS

FREQUENCY MHz	0.15	0.5	1.0	2.0	5.0	10	20	30		
COMMON dB	16	30	40	48	50	50	52	52		
DIFF. dB										

THIRD ANGLE PROJECTION

UNLESS OTHERWISE SPECIFIED,  
 TOLERANCE TO BE ±.025  
 MATERIAL & FINISH: AS SUPPLIED

This document is proprietary to CORCOM INC. and is not to be reproduced nor used for manufacturing purposes except on CORCOM'S prior written consent.

**tyco** Electronics **corcom**  
 620 S. BUTTERFIELD ROAD MUNDLEIGH IL 60060

### CUSTOMER DRAWING 1VB1

TYCO: 0-6609021-1	SCALE: NTS	DATE: 12SEP89	CATALOG NO.	REV.
DRW. BY: JF	ORIG: CW		1VB1	B