

# 0402 AS

Engineer's Kit : EK-0402AS-X

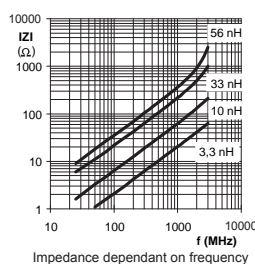
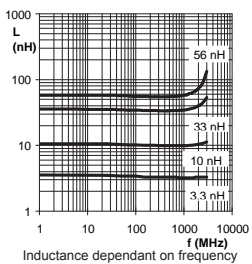
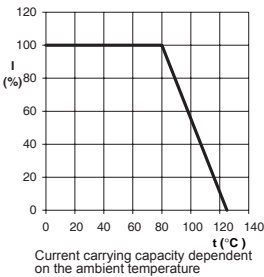
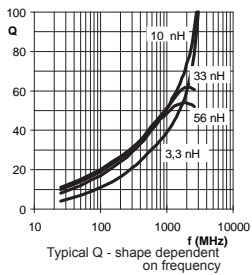
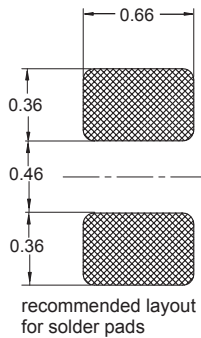
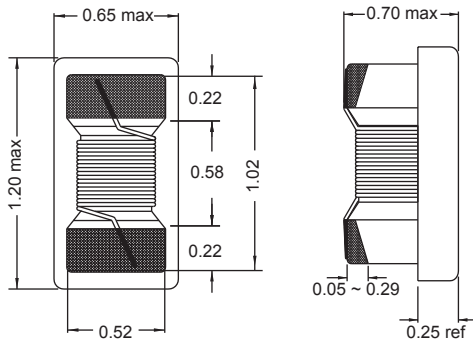
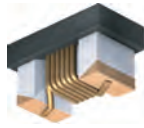

Part No	Inductance	f <sub>L</sub>	Tol	Q	f <sub>0</sub>	SRF <sup>1</sup>	DCR	Rated DC
	L (nH)	(MHz)	± (%)	min	(MHz)	(MHz)	max (Ω)	Current max (mA)
0402AS-0N9K-01	0.9	250	10	11	250	6000	0.04	1360
0402AS-1N0K-01	1.0	250	10	11	250	6000	0.07	700
0402AS-1N2K-01	1.2	250	10	11	250	6000	0.11	700
0402AS-1N8K-01	1.8	250	10	16	250	6000	0.07	1040
0402AS-1N9K-01	1.9	250	10	16	250	6000	0.07	1040
0402AS-2N0K-01	2.0	250	10	16	250	6000	0.07	1040
0402AS-2N2K-01	2.2	250	10	14	250	6000	0.11	640
0402AS-2N4K-01	2.4	250	10	16	250	6000	0.12	640
0402AS-2N5K-01	2.5	250	10	16	250	6000	0.12	640
0402AS-2N7K-01	2.7	250	10	16	250	6000	0.12	640
0402AS-2N9K-01	2.9	250	10	16	250	6000	0.10	700
0402AS-3N3K-01	3.3	250	10	20	250	6000	0.10	700
0402AS-3N6K-01	3.6	250	10	19	250	6000	0.10	700
0402AS-3N9K-01	3.9	250	10	19	250	4800	0.10	700
0402AS-4N3K-01	4.3	250	10	18	250	6000	0.091	700
0402AS-4N7K-01	4.7	250	10	15	250	4775	0.130	640
0402AS-5N1J-01	5.1	250	5	23	250	4800	0.083	800
0402AS-5N6J-01	5.6	250	5	22	250	4800	0.110	760
0402AS-6N2J-01	6.2	250	5	20	250	4800	0.110	760
0402AS-6N8J-01	6.8	250	5	21	250	4800	0.100	680
0402AS-7N5J-01	7.5	250	5	24	250	4800	0.100	680
0402AS-8N2J-01	8.2	250	5	24	250	4400	0.100	680
0402AS-8N7J-01	8.7	250	5	22	250	4160	0.160	681
0402AS-9N0J-01	9.0	250	5	22	250	4160	0.160	681
0402AS-9N1J-01	9.1	250	5	22	250	4000	0.200	480
0402AS-9N5J-01	9.5	250	5	22	250	4000	0.200	480
0402AS-010J-01	10	250	5	21	250	3900	0.200	480
0402AS-011J-01	11	250	5	24	250	3680	0.170	640
0402AS-012J-01	12	250	5	24	250	3600	0.170	640
0402AS-013J-01	13	250	5	24	250	3600	0.170	640
0402AS-015J-01	15	250	5	24	250	3280	0.170	560
0402AS-016J-01	16	250	5	24	250	3100	0.220	560
0402AS-018J-01	18	250	5	25	250	3100	0.23	420
0402AS-019J-01	19	250	5	24	250	3040	0.24	480
0402AS-020J-01	20	250	5	25	250	3000	0.25	420
0402AS-022J-01	22	250	5	25	250	2800	0.30	400
0402AS-023J-01	23	250	5	22	250	2720	0.30	400
0402AS-024J-01	24	250	5	22	250	2480	0.30	400
0402AS-027J-01	27	250	5	24	250	2480	0.30	400
0402AS-030J-01	30	250	5	24	250	2350	0.30	400
0402AS-033J-01	33	250	5	24	250	2350	0.30	320
0402AS-036J-01	36	250	5	24	250	2320	0.44	320
0402AS-039J-01	39	250	5	25	250	2100	0.55	200
0402AS-040J-01	40	250	5	25	250	2100	0.83	150
0402AS-043J-01	43	250	5	25	250	2100	0.75	150
0402AS-047J-01	47	250	5	25	250	2100	0.83	150
0402AS-051J-01	51	250	5	25	250	1760	0.97	100
0402AS-056J-01	56	250	5	25	250	1760	0.97	100
0402AS-068J-01	68	250	5	25	250	1620	0.97	100
0402AS-072J-01	72	100	5	15	100	1070	1.20	80
0402AS-082J-01	82	100	5	18	100	1070	1.20	80
0402AS-R10K-01	100	100	10	15	100	1070	1.20	80
0402AS-R12K-01	120	100	10	12	100	580	1.30	75
0402AS-R13K-01	130	100	10	10	100	450	1.30	70
0402AS-R15K-01	150	100	10	13	100	400	1.30	60
0402AS-R18K-01	180	50	10	10	50	380	1.50	65
0402AS-R20K-01	200	50	10	10	50	400	1.50	50
0402AS-R22K-01	220	50	10	10	50	190	2.00	50

Material : Ceramic      SPQ : Reel 5000 [-01]  
2000 [-08]

Remarks: - For not listed inductance values please check availability with us.  
- 2% & 5% available on request.  
- SRF<sup>1</sup> : 130nH to 220nH = SRF min  
: 0.9nH to 120nH = SRF typ