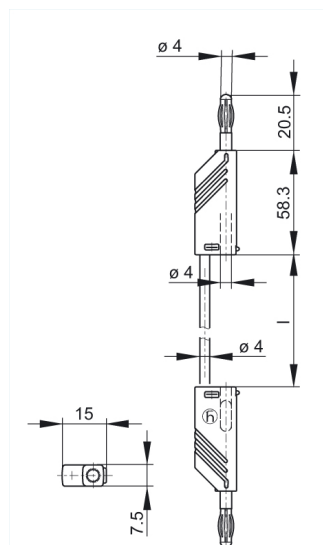

Industrial Connectors:Measuring and Testing Equipment:Measuring leads:4 mm system

Product description

Description	Measuring lead, at either end 4 mm diameter plug with caged spring and 4 mm diameter socket for tower construction. Nickel-plated copper beryllium contact spring. Highly flexible, double insulated stranded lead, grip and lead shatter-proof. Built in colour indicator for easy identification of insulation damages.
Type	MLN 50/1 schwarz/black
Order No.	934 060-100
System	4 mm system
Cable length	50 cm
Conductor size	1 mm ²
Cable material	PVC
Cable color	black
Housing Color	black
Other standard types	red color, order no. 934 060-101; blue color, order no. 934 060-102; yellow color, order no. 934 060-103; green color, order no. 934 060-104

Drawing**Technical data**

Pin dimensions	4 mm
Type of contact	pin (spring loaded)
Type of termination	4 mm diameter pin and socket
Cable type	LEH-XY
Cable specification	highly flexible lead

Wire stranding	259 x 0,07
Rated voltage	DC 60 V
Rated current	16 A
Contact resistance	13 mOhm
Material	
Contact material	contact pin: brass, contact spring: copper beryllium
Contact surface material	nickel-plated
Housing material	PA
Environmental conditions	
Temperature range	-15 °C to +70 °C
Inflammability class	
Cable	94 HB
Housing	94 V-2