

## BY4 ... BY16

### High Voltage Silicon Rectifier Diodes Silizium-Hochspannungs-Gleichrichterdioden

Version 2013-04-03

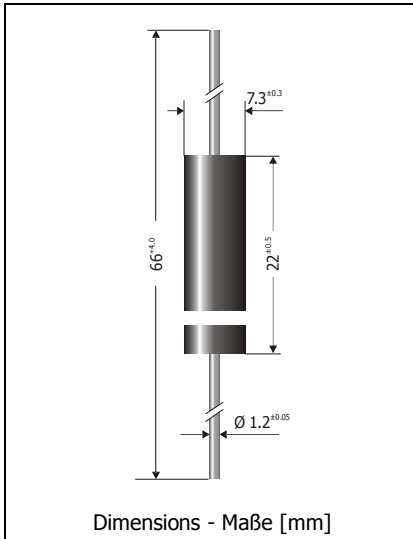

Nominal current Nennstrom	0.3 A ... 1 A
Repetitive peak reverse voltage Periodische Spitzensperrspannung	4000...16000 V
Plastic case Kunststoffgehäuse	Ø 7.3 x 22 [mm]
Weight approx. Gewicht ca.	1.9 g
Plastic material has UL classification 94V-0 Gehäusematerial UL94V-0 klassifiziert	
Standard packaging taped in Reel Standard Lieferform gegurtet auf Rolle	



#### Maximum ratings and Characteristics

#### Grenz- und Kennwerte

Type Typ	Rep. peak reverse volt. Period. Spitzensperrspg. $V_{RRM}$ [V]	Surge peak reverse volt. Stoßspitzensperrspg. $V_{RSM}$ [V]	Max. forward current Dauergrenzstrom $I_{FAV}$ [A] <sup>1)</sup>	Forward volt. Durchlass-Spg. $V_F$ [V] <sup>2)</sup>
BY4	4000	4000	1.0	< 4.0
BY6	6000	6000	1.0	< 6.0
BY8	8000	8000	0.5	< 8.0
BY12	12000	12000	0.5	< 10.0
BY16	16000	16000	0.3	< 15.0

Leakage Current Sperrstrom	$T_j = 25^\circ\text{C}$ $T_j = 100^\circ\text{C}$	$V_R = V_{RRM}$ $V_R = V_{RRM}$	< 1 $\mu\text{A}$ < 25 $\mu\text{A}$
Peak forward surge current, 50 Hz half sine-wave Stoßstrom für eine 50 Hz Sinus-Halbwellen	$T_A = 25^\circ\text{C}$	$I_{FSM}$	30 A
Rating for fusing, $t < 10$ ms Grenzlastintegral, $t < 10$ ms	$T_A = 25^\circ\text{C}$	$i^2t$	4.5 A <sup>2</sup> s
Junction temperature – Sperrschichttemperatur Storage temperature – Lagerungstemperatur	$T_j$ $T_s$		-50...+150°C -50...+150°C
Thermal resistance junction to ambient air Wärmewiderstand Sperrschicht – umgebende Luft		$R_{thA}$	< 25 K/W <sup>1)</sup>

- 1 Valid, if leads are kept at ambient temperature  $T_A = 50^\circ\text{C}$  at a distance of 10 mm from case  
Gültig, wenn die Anschlussdrähte in 10 mm Abstand vom Gehäuse auf Umgebungstemperatur  $T_A = 50^\circ\text{C}$  gehalten werden
- 2 At / Bei  $I_{FAV}, T_j = 25^\circ\text{C}$

