

THIS DOCUMENT IS THE PROPERTY OF  
KEYSTONE ELECTRONICS CORP. AND  
SHALL NOT BE REPRODUCED, DISTRIBUTED  
OR USED AS A BASIS FOR MANUFACTURE  
WITHOUT PRIOR WRITTEN PERMISSION  
FROM KEYSTONE ELECTRONICS CORP.

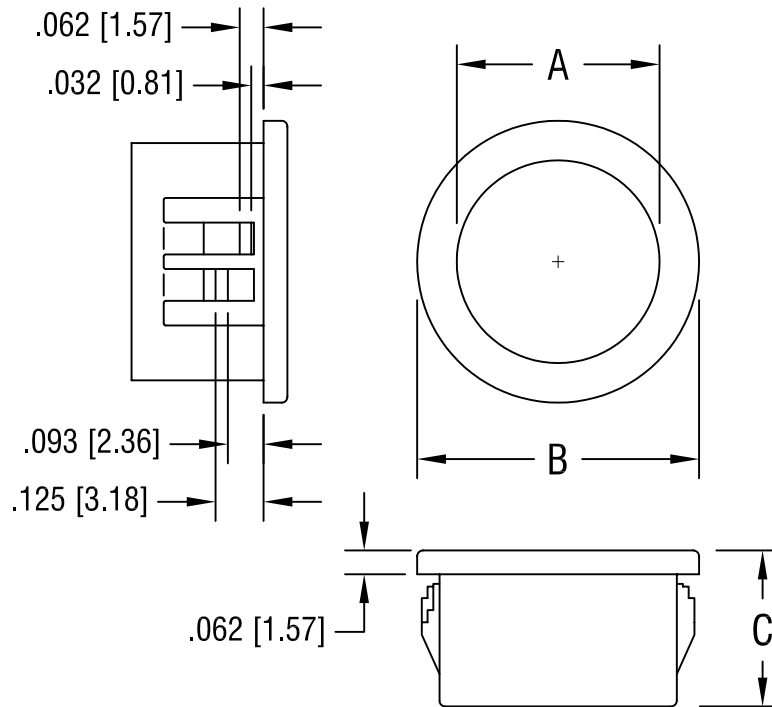

MOUNTING HOLE	'A' DIA.	'B' DIA.	'C' DIM.
.250 [6.4]	.125 [3.18]	.312 [7.92]	.312 [7.92]

**KEYSTONE ELECTRONICS CORP.**

ASTORIA, N.Y. 11105-2017

PART NAME

NYLON INSULATING BUSHING

MATERIAL

NYLON 6/6, BLACK UL 94V-2

FINISH

-

DRN BY

BOONE

DATE

11.22.06

APP'D

SCALE

NONE

TOLERANCES

INCH [MM]

DECIMAL  $\pm .015$  [ $\pm 0.38$ ]

ANGULAR  $\pm 1^\circ$   
UNLESS OTHERWISE SPECIFIED

CODE

C/M

DWG NO.

8470

DATE

DESCRIPTION

REV.