

# PRODUCT DATASHEET

is brought to you by



[SOS electronic](https://www.soselectronic.com/)

distribution of electronic components

Click to view availability, pricing and lifecycle information.

Visit <https://www.soselectronic.com/>

**Datasheet begins on next page.**

**SPECIFICATIONS**

(Typical values for batteries stored at 20°C for one year)

Nominal Capacity(At 3mA/20°C/68°F/2.0V Cut-Off)	7.2 Ah
Open Circuit Voltage(At 20°C/68°F)	3.67 V
Nominal Voltage(At 3mA/20°C/68°F)	3.6 V
Maximum Continuous Current	230 mA
Maximum Pulse Current Capability	400 mA
Rated 1 Sec. Pulse Capability(To 3V)	60 mA
Operating Temperature Range	-55 ~ 85 °C
Weight	50.5 g(1.78 oz)
Anode Surface Area	30 cm <sup>2</sup>
Volume	26 cm <sup>3</sup>
Diameter(Max)	26.2 mm
Height(Max)	50 mm

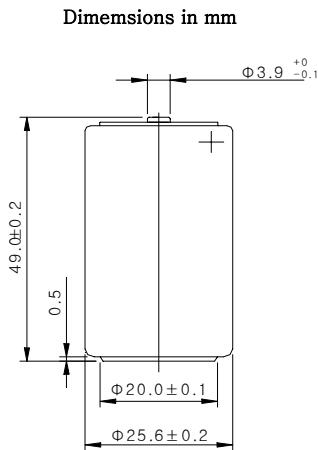

**WARNING**  
Fire, Explosion And Severe Burn Hazard.  
Do Not Recharge, Crush, Disassemble,  
Heat Above 212°F(100°C), Incinerate  
Or Expose Contents To Water

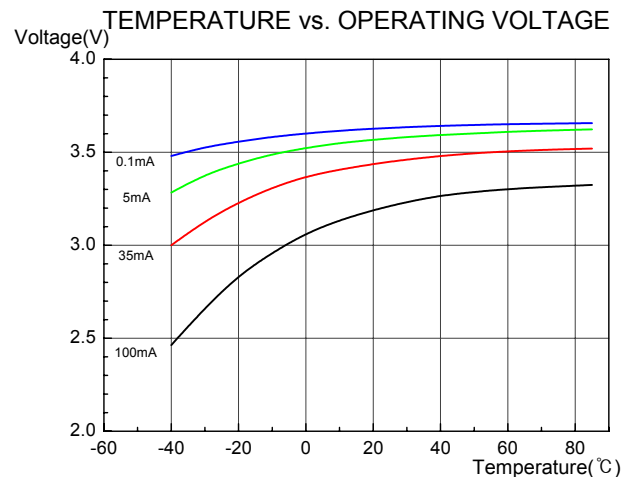
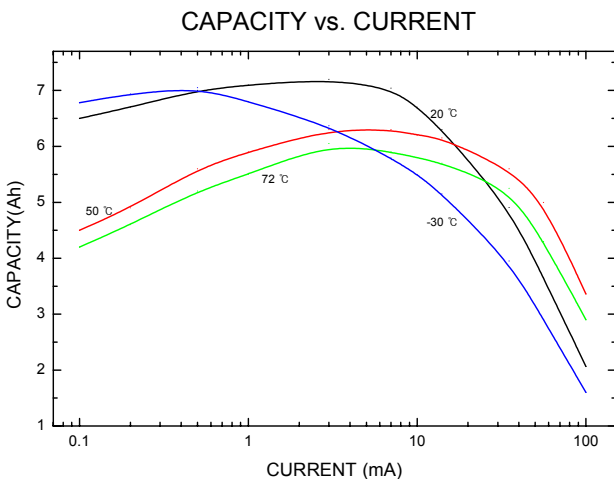
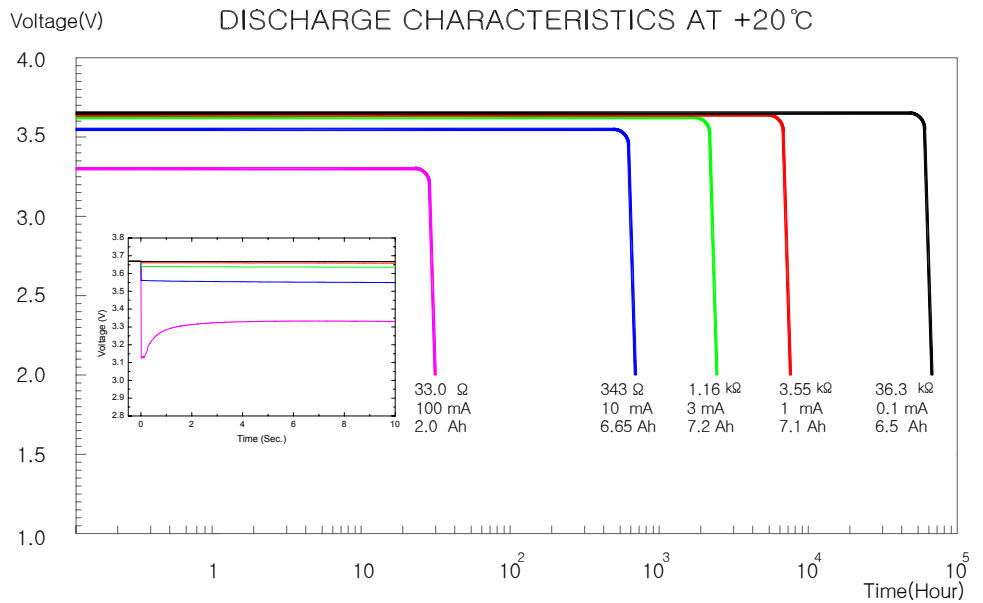

1. STD Terminal

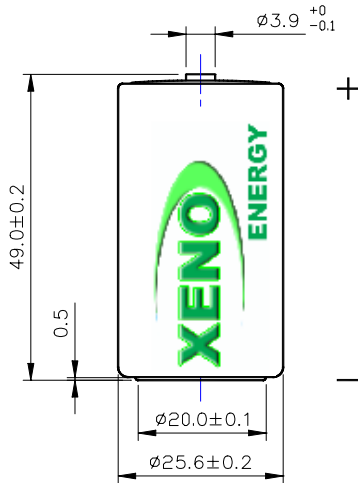

2. Connector

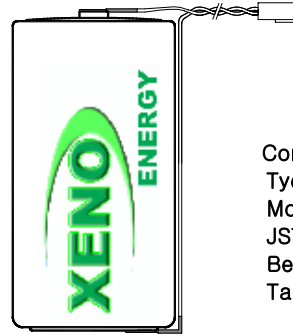

Connector Type :  
Tyco  
Molex  
JST  
Berg  
Tamiya

3. AX Terminal

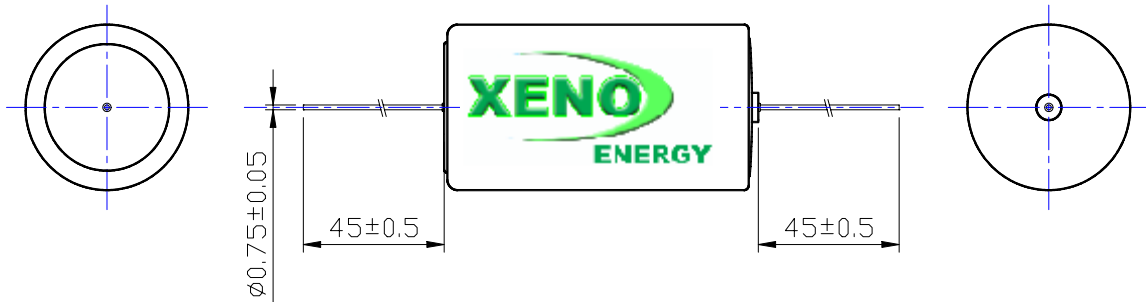

4. T1 Terminal

