

CONFIDENTIAL

VERTRAULICH

Alle Rechte bei Marquardt, auch fuer den Fall von Schutzrechtsanmeldungen. Jede Veruegungsbezugnis, wie Kopier- und Weitergaberecht, bei uns.

THIS DRAWING IS THE EXCLUSIVE PROPERTY OF MARQUARDT. WITHOUT THEIR CONSENT IT MAY NOT BE REPRODUCED OR GIVEN TO THIRD PARTIES.

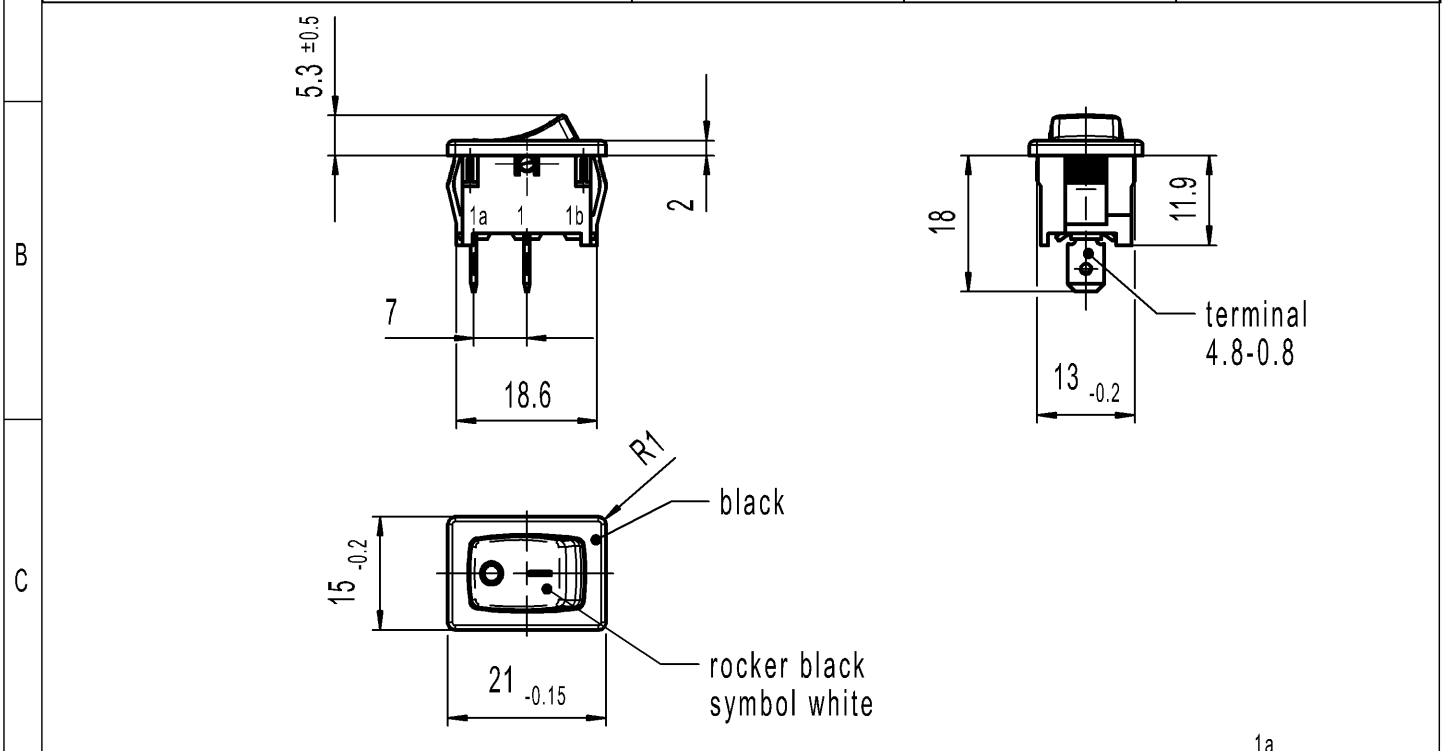

A	recommended cut-out for snap-in fixing (edge opposite to snap-in direction)	1	2	3	4
			wall thickness	length of cut-out	width of cut-out
			0.75 to 1.25	19.2 -0.1	12.9+0.1
			1.25 to 2	19.4 -0.1	12.9+0.1
		2 to 3	19.8 -0.1	12.9+0.1	



Marking



 18..
 6 (4) /250~5E4 T100/55
 10 (4) /250~
 5/50A 250V~

SPST
Suitable for appliances of class II

6A 125-250V AC
 1/4 HP 125V AC
 1/2 HP 250V AC
 R 30  

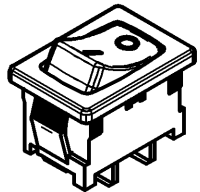
Code of manufacture: place/year/week
 On box: 1801.1146
 Customer Part No. see variant table

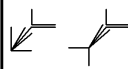

-		-		11000743A	1801.1146-XX
Figure		Type		Customer Part No.	Art.No.-PI
Shape and location	Angle ± 2 °	Length		Sheet 01	Ident. K
	Edge tolerance	>0-6 ± 0.2	± 0.2	Format DIN A4	Document number 18011146
		>6-15 ± 0.4	±	Projection 	Index f
		>15-30 ± 0.4	±	Scale 1:1	Appliance Switch
	>30-70 ±	±	All dimensions are in millimetres	MARQUARDT	
	>70-120 ±	±			System NX V1872
	>120-200 ±	±	Replacement of		
f	137838	2021-08-12	MOHITEN	Zg.gl.Nr.v.24.06.1997	
e	43724	2005-07-19	vor		
d	32554	2002-04-11	SIG		
c	25088	1997-06-24	SIG		
Index	MEC-No.	Date (YYYY-MM-DD)	Edited by		