

IEC Appliance Inlet C14 with Filter



Approvals and Compliances

Description

- Panel Mount :
Screw-on mounting from front side
- 2 Functions :
Appliance Inlet Protection class I , Line-filter in standard version
- Quick connect terminals 6.3 x 0.8 mm

Characteristics

- Compact design with optimal shielding
- All single elements are already wired
- Universal line filter for standard applications
- Suitable for use in equipment according to IEC/UL 60950

Weblinks

[pdf datasheet](#), [html-datasheet](#), [General Product Information](#), [Distributor-Stock-Check](#), [Accessories](#), [Detailed request for product](#), [Microsite](#)

Newly available variants corresponding to V-Lock mating cordset. The connector is equipped with a notch intended for use with the latching cordset. The cord latching system prevents against accidental removal of the cordset.

Technical Data

Ratings IEC	1 - 10A @ Ta 40 °C / 250VAC; 50Hz	appliance inlet/-outlet	C14 acc. to IEC 60320-1,
Ratings UL/CSA	1 - 10A @ Ta 40 °C / 125VAC; 60Hz		UL 498, CSA C22.2 no. 42 (for cold conditions) pin-temperature 70 °C, 10A, Protection Class I
Leakage Current	standard < 0.5mA (250V / 60Hz)	Line Filter	Standard Version, IEC 60939, UL 1283, CSA C22.2 no. 8 Technical Details
Dielectric Strength	> 1.7kVDC between L-N > 2.7kVDC between L/N-PE Test voltage (2 sec)	MTBF	> 3'100'000h acc. to MIL-HB-217 F
Impulse Withstand Voltage	> 2.5kV between L-N (CX2) > 5kV between L/N-PE		
Allowable Operation Temperature	-25 °C to 85 °C		
Climatic Category	25/085/21 acc. to IEC 60068-1		
IP-Protection	from front side IP 40 acc. to IEC 60529		
Protection Class	Suitable for appliances with protection class I acc. to IEC 61140		
Terminal	Quick connect terminals 6.3 x 0.8 mm		
Panel Thickness S	Screw: max 8 mm Mounting screw torque max 0.5Nm		
Material: Housing	Thermoplastic, black, UL 94V-0		

Approvals and Compliances

Detailed information on product approvals, code requirements, usage instructions and detailed test conditions can be looked up in [Details about Approvals](#)

Approvals







The approval mark is used by the testing authorities to certify compliance with the safety requirements placed on electronic products.

Approval Reference Type: KFS

Approval Logo	Certificates	Certification Body	Description
	VDE Approvals	VDE	Certificate Number: 40004665 (FGS)
	UL Approvals	UL	UL File Number: E72928 (FGS)

Product standards

Product standards that are referenced

Organization	Design	Standard	Description
	Designed according to	IEC 60320-1	Appliance couplers for household and similar general purposes
	Designed according to	IEC 60939	Passive filters for suppressing electromagnetic interference
	Designed according to	IEC 61058-1	Switches for appliances. Part 1. General requirements
	Designed according to	UL 498	Standard for Attachment Plugs and Receptacles
	Designed according to	UL 1283	Electromagnetic interference filters
	Designed according to	CSA C22.2 no. 42	General Use Receptacles, Attachment Plugs, and Similar Wiring Devices
	Designed according to	CSA C22.2 no. 8	Electromagnetic interference (EMI) filters





Application standards

Application standards where the product can be used

Organization	Design	Standard	Description
	Designed for applications acc.	IEC/UL 60950	IEC 60950-1 includes the basic requirements for the safety of information technology equipment.

Compliances

The product complies with following Guide Lines

Identification	Details	Initiator	Description
	CE declaration of conformity	SCHURTER AG	The CE marking declares that the product complies with the applicable requirements laid down in the harmonisation of Community legislation on its affixing in accordance with EU Regulation 765/2008.
	RoHS	SCHURTER AG	EU Directive RoHS 2011/65/EU
	China RoHS	SCHURTER AG	The law SJ / T 11363-2006 (China RoHS) has been in force since 1 March 2007. It is similar to the EU directive RoHS.
	REACH	SCHURTER AG	On 1 June 2007, Regulation (EC) No 1907/2006 on the Registration, Evaluation, Authorization and Restriction of Chemicals 1 (abbreviated as "REACH") entered into force.
	MicrositeV-Lock	SCHURTER AG	V-Lock system are based on a matching plug-dose combination. The connector is equipped with a notch intended for use with the latching cordset. The cord latching system prevents against accidental removal of the cordset.

Dimension [mm]

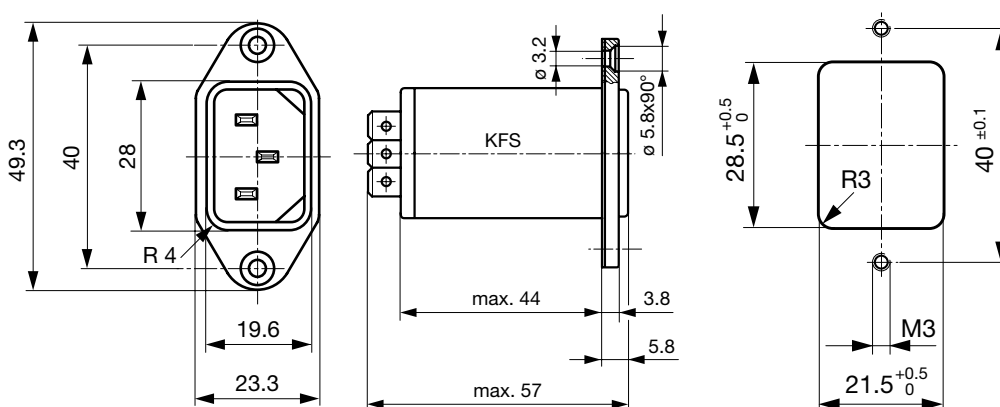

Technical Data of Filter-Components

Rated Current [A]	Filter-Type	Inductances L [mH]	Capacitance CX [nF]	Capacitance CY [nF]
1	Medical Version (M80)	2 x 10	47	0.47
1	Medical Version (M5)	2 x 10	47	-
2	Medical Version (M5)	2 x 4	47	-
4	Medical Version (M5)	2 x 1.5	47	-
6	Medical Version (M5)	2 x 0.8	47	-
10	Medical Version (M5)	2 x 0.3	47	-
1	Standard Version	2 x 10	47	2.2
2	Standard Version	2 x 4	47	2.2
4	Standard Version	2 x 1.5	47	2.2
6	Standard Version	2 x 0.8	47	2.2
10	Standard Version	2 x 0.3	47	2.2

Diagrams

Standard version

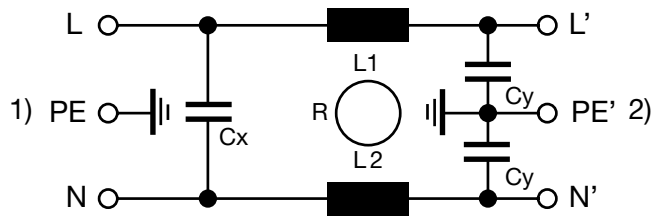

- 1) Line
- 2) Load

Attenuation Loss

--- 50Ω differential mode ____ 50Ω common mode

Standard version

1 A

2 A

4 A

6 A

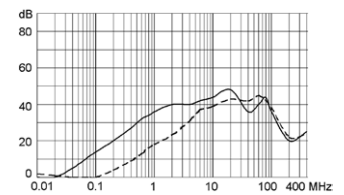
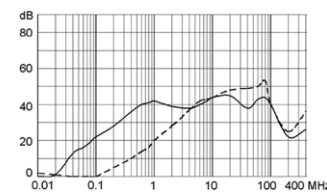
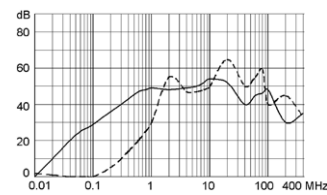
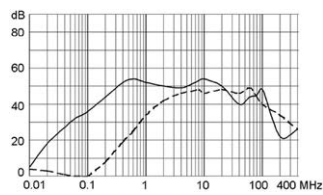

10 A

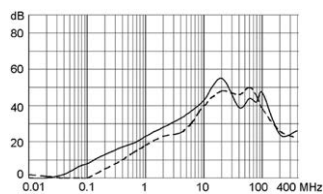

All Variants

Type	Rated Current [A]	Filter-Type	CX Class	V-Lock	Order Number
KFS	1	Standard Version	X2		4300.5051
KFS	2	Standard Version	X2		4300.5052
KFS	4	Standard Version	X2		4300.5053
KFS	6	Standard Version	X2		4300.5054
KFS	10	Standard Version	X2		4300.5055
KFS	1	Medical Version (M5)	X2		4300.5021
KFS	2	Medical Version (M5)	X2		4300.5022
KFS	4	Medical Version (M5)	X2		4300.5023
KFS	6	Medical Version (M5)	X2		4300.5024
KFS	10	Medical Version (M5)	X2		4300.5025
KFS	1	Medical Version (M80)	X2		4300.5031

Most Popular:

Availability for all products can be searched real-time: <https://www.schurter.com/en/Stock-Check/Stock-Check-SCHURTER>

Packaging unit 10 Pcs

Accessories

Description

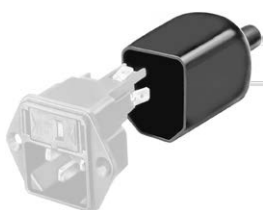

Assorted Covers
Rear Cover

0859.0048



Cord retaining kits
Cord retaining strain relief

Countersunk, C

4700.0003

Mating Outlets/Connectors

Category / Description

Appliance Outlet Overview complete



IEC Appliance Outlet F, Screw-on Mounting, Front Side, Solder Terminal	4787
IEC Appliance Outlet F, Snap-in Mounting, Front Side, Solder or Quick-connect Terminal	4788
IEC Appliance Outlet F or H, Screw-on Mounting, Front Side, Solder, PCB or Quick-connect Terminal	5091

Appliance Outlet further types to KFS



[Connector Overview complete](#)

4782 Mounting: Power Cord, 3 x 1 mm ² / 3 x 18 AWG, Cable, Connector: IEC C13	4782
4022 Mounting: Power Supply Cord, 3 x 1.5 mm ² , Screw clamps, Connector: IEC C13	4022
4785 Mounting: Power Cord, 3 x 1 mm ² / 3 x 18 AWG, Cable, Connector: IEC C13	4785
4300-06 Mounting: Power Cord, 3 x 1 mm ² / 3 x 18 AWG, Cable, Connector: IEC C13	4300-06
4012 Mounting: Power Supply Cord, 3 x 1.5 mm ² , Screw clamps, Connector: IEC C13	4012
Connector further types to KFS	...

Mating Outlets/Connectors shuttered



[Power Cord Overview complete](#)

VAC13KS, Overview, diverse Connector IEC C13, cord end:	VAC13KS
Power Cord further types to KFS	