



Technical Data Sheet

UW-U4Z

Ver. UW-U4Z-en-man-V1



1. Table of contents

1.	Table of contents	2
2.	Features	4
3.	Introduction	5
4.	Distance between mount holes	6
5.	Terminal description	6
6.	Specifications	7
7.	Communication with the reader	8
7.1.	Serial transmission frame format	8
	Transmission of commands and responses	9
8.	Calculation the CRC value	9
8.1.1.	Address types	10
8.1.2.	Selective	10
8.1.3.	Group	10
8.2.	Division of reader modes on basis of communication	11
8.2.1.	Autonomous	11
8.2.2.	Remote	11
8.2.3.	Mixed	11
9.	Features of the Unique transponder	12
10.	Division of user cards on basis the functions performed in reader	13
10.1.	“Access control” card	13
10.2.	„Master” card	13
11.	User card handling	13
11.1.	Adding and removing the “master” cards	13
11.1.1.	Via the RS-485 interface	13
11.1.2.	By means of first access	13
11.2.	Adding and removing “access control” cards	14
11.2.1.	Via the RS-485 interface	14
11.2.2.	With the help of „master” card	14
11.3.	Restoring the reader defaults	14
11.3.1.	By means of push button	14
11.3.2.	By means of RS-485 interface	14
12.	Anti-collision connection of two readers	15
13.	Command description:	16
13.1.	Read-out of the Unique transponder	16
13.2.	Driving the buzzer and relay	17
13.3.	Read-out of the push-button status	17
13.4.	Reading of card ID from reader memory	18
13.5.	Writing of card ID to reader memory	18
13.6.	On and off reader memory	18
13.7.	Logging to the reader	19
13.8.	Changing the password	19
13.9.	Forcing the default settings	20
13.10.	Changing the reader configuration	20
13.10.1.	Configuration examples	24
13.11.	Read-out of the UW-U4Z reader software version	25
14.	Operation codes sent back by reader	25

15.	Examples of the UW-U4Z reader operation	26
15.1.	Access control function	26
15.2.	Writing the ID as a "master" card	28
15.3.	Writing the ID as a „access control” card	30
15.3.1.	Writing via RS-485 bus.....	30
15.3.2.	Writing with the help of "master" card	30

2. Features

- Dimensions: 82 x 82 x 23 mm,
- For the UNIQUE identifiers,
- Operates in wide supply voltage range 7 to 16 V (non stabilized voltage),
- The RS485 interface with possibility:
 - to connect up to 32 readers on common bus,
 - to call the reader with the help of unique address or to call all readers connected to the bus at the same time,
 - to configure the readers,
 - to write in the respective readers of user identifiers,
 - to service and manage the readers in system;

The reader configuration includes:

- setting the communication interface capacity 1200....115200 bps
- selective or group addressing
- master system informing about properly red identifier
- setting the relay mode: monostable, bistable or off
- setting the relay hold time
- setting the switch-on time of buzzer

An internal non-volatile memory enables:

- to memorize of 1000 user identifiers numbers,
- to memorize up to 10 master identifiers (MASTER);

A reader can drive the electromagnetic lock with internal relay directly.

An internal reader collision driver enables to position the readers close to each other.

The reader has universal push-button.

3. Introduction

The UW-U4Z reader makes it possible the contact-less reading of the unique number from the UNIQUE type electronic identifier (transponder). A user can configure the reader to conform the application requirements on possibilities mentioned below:

The unit is equipped with RS-485 interface. It makes possible either to configure a single reader or to connect up to 32 readers to the same bus. Communication of the master system with readers is provided with single and total addressing. The available communication functions enable the memorized cards management, configuration, internal relay driving, internal acoustic and optical alarm driving, reading the status of the push-button located on front panel and the transponder ID number reading.

A proper reader configuration can make the reader to be full autonomous unit, it means to make the decisions based on numbers of authorized identifiers, defined and memorized previously in internal non-volatile memory. On that basis, the reader can perform the previously defined actions, such us:

- driving any appliances,
- blocking or opening different security equipment,
- driving the alarm units,
- timing generation for support above functions in time,
- reading the push-button located on front panel,
- reading the ID number of an identifier.

The configuration makes it possible to create the autonomous reader, it means, operating without influence of the master unit (the RS-485 bus) or on control of master system (PC or dedicated equipment) or operate on mixed mode (in case of such demand the autonomous reader can be reconfigured). The reader can operate with baud rate of 1200 , 2400, 4800, 9600, 19200, 38400, 57600, 115200 bps. The reader can be configured to respond on same card applied to it, or to respond in case of card first application, it means transmitting the ID spontaneously or on demand. The relay can operate on the bistable or monostable mode, where its hold time can be configured too.

The relay driving can be performed remotely or in connection with registered card application or with application of any card.

The status of the internal push-button can be read remotely. It makes possible to organize additional functionality.

The reader has a memory of 1000 “access control” cards and 10 “master” cards. These cards enable to register or remove other card in the reader (the master card adds or removes other cards).

During programming via RS bus, the configuration and card memory is secured with password.

The reader has an internal collision driver, which enables to place the readers in proximity to each other (on the same wall or on both sides of it).

4. Distance between mount holes

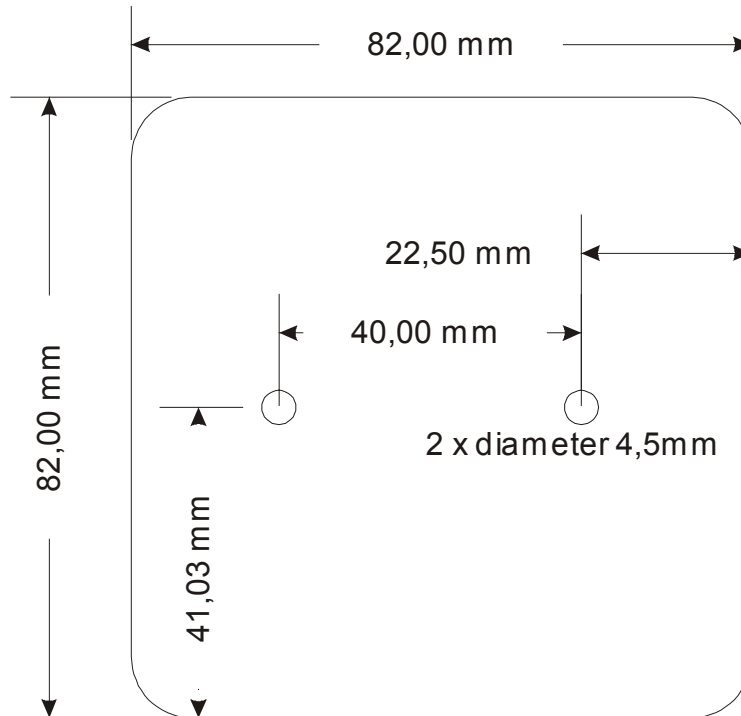

5. Terminal description

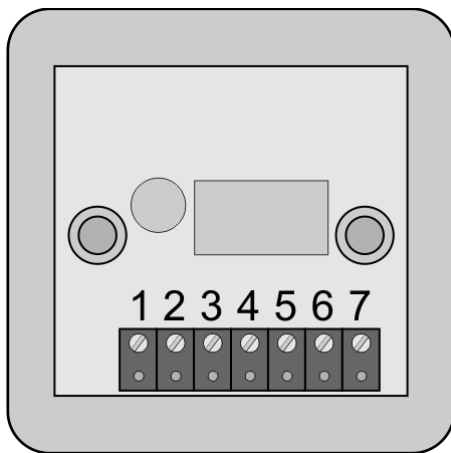

Drawing: Terminals view from terminal screw panel side

1- synchronization of the readers operating on distance less than 30 cm.

(terminal non-connected for the reader 1)

2- RS-485 bus – terminal A

3- RS-485 bus – terminal B

4- the reader DC voltage supply (+ pole)

5- the reader DC voltage supply (- pole)

6- internal relay contact terminal

7- internal relay contact terminal

6. Specifications

Dimensions	82 x 82 x 23 mm
Supply voltage Uz	7...16 V
Supply current	30...60 mA
Rated operating frequency of the RF module	125 kHz
Type of modulation the data received from the transponder.	Manchester
Baud rate the data received from the transponder.	RF/64 (1953 bps)
Read distance of transponders (depends on transponder used)	up to 12 cm
“Control access” card memory	1000 cards
“Master” card memory	10 cards
Antenna	internal
Communication parameters	1200, 2400, 4800, 9600, 19200, 38400, 57600, 115200 bps, 8 data bits, 1 stop bit, no parity bit, with current levels conform RS-485 format.
Maximum readers number in bus	32
Reader addresses in RS-485 bus	any within 1...254 range

7. Communication with the reader

7.1. Serial transmission frame format

General format of command frame for the reader.

Module address	Frame length	Command	Parameters 1..n	CRCH	CRCL
1 byte	1 byte	1 byte	n * bytes	1 byte	1 byte

Where:

Module address – module address in system

If:

Module address = 0 – any module will respond

Module address = 0xFF any module in network will respond one by one

Frame length – total frame bytes number

Command – even value

Parameters 1..n – exist optionally and depend on command

CRCH, CRCL - older and younger byte of CRC16 value respectively

General format of response frame for the reader.

Module address	Frame length	Response	Parameters 1..n	Operation code	CRCH	CRCL
1 byte	1 byte	1 byte	n * bytes	1 byte	1 byte	1 byte

Where:

Module address – real defined address for the responding module

Frame length – total bytes number of response frame

Response = Command + 1 (odd value)

Parameters 1..n - exist optionally and depend on command

Operation code – informs about correctness executed command

CRCH, CRCL - older and younger byte of CRC16 value respectively

Transmission of commands and responses

On remote mode the reader operates in the virtue of:

Query (from master unit - host - action (of the module) - response (of the module).

The query – command is sent to the module UW-U4Z:

module address	frame length	command	data	CRCH,CRCL
XX	XX	XX	XX XX XX	XX XX

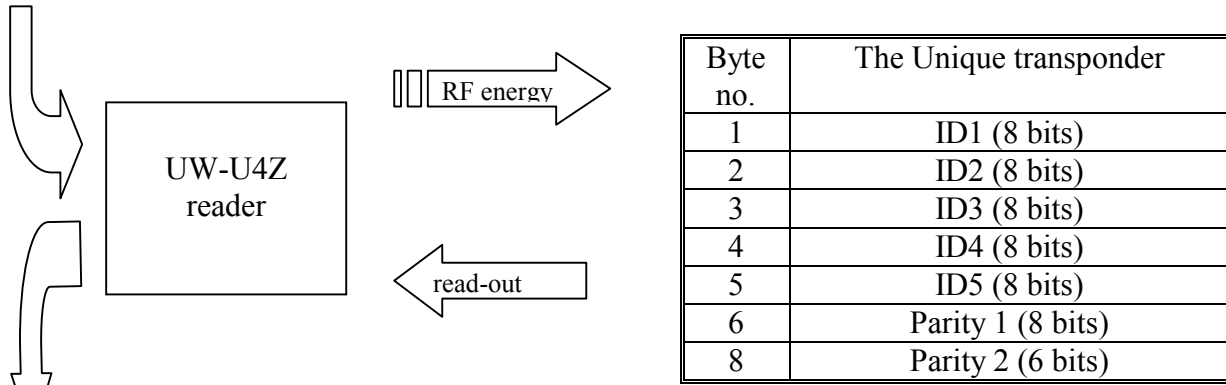

The response received:

module address	frame length	response	data	operation code	CRCH,CRCL
XX	XX	XX	XX XX	XX	XX XX

8. Calculation the CRC value

The CRC value is calculated from equation $x^{16}+x^{12}+x^5+1$ with initial value equal to 0x0000. The CRC value is calculated in virtue of all the bytes except of CRCH and CRCL.

Example of calculation of CRC value, written in C language:

```
void LiczCRC2(unsigned char *ZAdr, unsigned short *DoAdr, unsigned char Ile)
{
    int i,NrBajtu;
    unsigned short C;
    *DoAdr=0;
    for (NrBajtu=1;NrBajtu<=Ile;NrBajtu++,ZAdr++)
    {
        C=((*DoAdr>>8)^*ZAdr)<<8;
        for (i=0;i<8;i++)
            if (C&0x8000) C=(C<<1)^0x1021;
            else C=C<<1;
        *DoAdr=C^(*DoAdr<<8);
    }
}
```

where:

*Zadr - is the data first byte flag

Ile - informs how many data bytes will be used for calculation

*DoAdr - is the flag for the calculated CRC value

8.1.1. Address types

8.1.2. Selective

In case of single reader addressing, include its substantial address in sending query. In that case, the reader will send the response right back, after performing the command is finished.

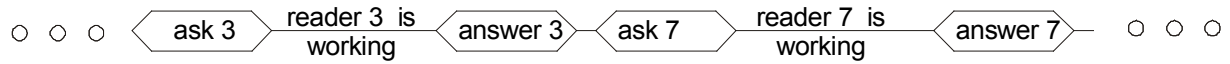

Drawing. Querying the readers with 0x03 and 0x07 addresses and their responses.

8.1.3. Group

In case of many readers addressing, include address=0xff in sending query. In that case, the readers will send the responses, according to their addresses, one by one, in their time slots.

Drawing. The query sent to all readers and their responses.

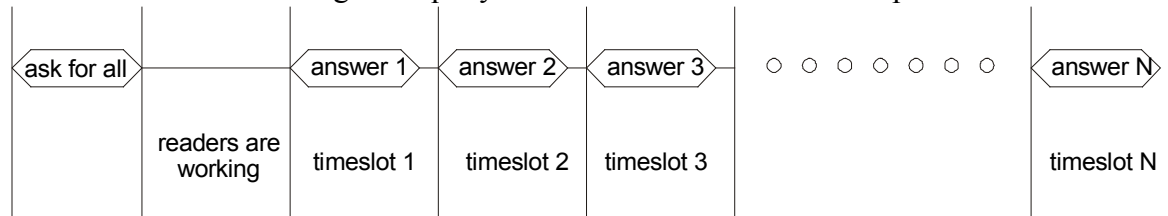

8.2. Division of reader modes on basis of communication

8.2.1. Autonomous

The „autonomous” mode of operation means, that reader does not communicate with the master unit continuously. It is possible not to connect the RS-485 network at all, but only to supply the reader and the lock.

This configuration can take place, where reader configured earlier is handled with the help of “master” cards and where the reader decides if to open the door in virtue of the internal base of 1000 cards.

To get such configuration to operate, first input it to the “master” card reader memory, via the RS-485 interface. It can be done, just before the mounting the reader in the building, it means at place where the RS-485 is available.

Acoustic signals during “master” card” operation	
activity	reaction
read-out of “master” card”	two short beeps
adding the „access control” card	Relay-ON
canceling the “access control” card	like unknown card
out of memory during adding the „access control” card	one long beep

8.2.2. Remote

On “remote” mode of operation, the master unit reads all readers in real time, compares the ID numbers red-out cards with its numbers in central card base, and decides if to open the locks, and if yes it sends the messages informing about switching on. In that case, the master unit controls the access. To have the “remote” mode to operate, all the readers and the master unit should be connected to the RS-485 network.

8.2.3. Mixed

The “mixed” mode of operation combines features of autonomous and remote mode of operation. In such configuration, the readers decide if to open the lock, but simultaneously are connected to the RS-485 network with master unit, which can reconfigure following readers.

9. Features of the Unique transponder

The Unique transponder (EM Microelectronic –Marin SA H4102 standard) comprises 5 bytes with the laser written non-repeatable ID number. The correctness of the written data is secured with parities written in the next two bytes. Owing to the UM-005 reader, the ID number is read, the read-out correctness is checked automatically, and then the number is sent to the master unit via serial interface.

Byte no.	The Unique transponder
1	ID1 (8 bits)
2	ID2 (8 bits)
3	ID3 (8 bits)
4	ID4 (8 bits)
5	ID5 (8 bits)
6	Parity 1 (8 bits)
8	Parity 2 (6 bits)

10. Division of user cards on basis the functions performed in reader

10.1. "Access control" card

This Unique card will cause lock open, after register it on any position within the 0x0000 to 0x03e7 range, and after applying it to properly configured reader (for instance with default setting).

10.2. „Master” card

This Unique card will allow to add and remove to or from the memory the access control card reader respectively, after registering it on any position within the 0x03e8 to 0x03f1 range.

11. User card handling

11.1. Adding and removing the “master” cards

11.1.1. Via the RS-485 interface

The “master” card is registered in the reader memory, via the RS interface , with the C_CardWrite command. Such registration is possible, if logging is done to the reader earlier, with the C_Password command.

To reader recognize the card as a “master”, register the card within positions 0x03e8 to 0x03f1 range.

The removing process is the same as registration, but the only difference is, that instead of the card ID number is using the ID=0xff ff ff ff.

11.1.2. By means of first access

The UW-U4Z reader factory configured has no "Master" card preprogrammed. After switching the power supply on, and applying of any card for the first time, the ID of the card is written to reader memory in the position 1000.

One can remove or add more than one "Master" card via RS-485 interface.

To remove all cards from reader memory, in case to get the reader configured as a new reader, do restore reader defaults procedure.

Reader witch done C_ResetCardMemory command hasn't any card in reader memory so it write first card as a “Master” card.

11.2. Adding and removing “access control” cards

11.2.1. Via the RS-485 interface

The “access control” card can be registered via the RS interface, with C_CardWrite command. Such registration is possible after earlier logging to the reader with C_Password command only.

To reader recognize the card as a “control access” card, register it within positions 0x0000 to 0x03e7 range.

The removing process is the same as registration, but the only difference is, that instead of the card ID number use the ID=0xff ff ff ff ff.

11.2.2. With the help of „master” card

The using of “master card” is alternative and very convenient way of adding and removing of “access control” cards in case we use RS interface for it.

To add the “access control” card, apply the “master” card to the reader first (two long beeps), and then during five seconds, apply to the reader new and never registered unique card. Hence the new card becomes the “access control” card and will be recognized by the reader.

To remove the “access control” card, apply the “master” card to the reader first (two short beeps), and during five seconds, apply to it earlier registered “access control” card. Hence the reader will not recognize the card.

11.3. Restoring the reader defaults

11.3.1. By means of push button

To restore the reader defaults and clear its cards memory, one needs to perform following operations:

- remove reader power supply,
- push a button on device front panel in,
- switch the power supply on, while holding the push-button on,
- hold the push-button during 10 s steadily,
(the reader warns user with acoustic signal, that the reader begins defaults restoring and clearing card memory),
- now user can release the push-button.

Programming procedure lasts ca. 10 s, and during the operation red lamp blinks. Having termination the operation, reader returns to normal mode.

11.3.2. By means of RS-485 interface

For clearing card memory and setting default properties use C_ResetCardMemory command.

12. Anti-collision connection of two readers

In case of placing two collision readers in very near proximity (less than 20 cm), the readers will disturbance each other, and the distance will decrease dramatically, so the reader can not operate at all. The UW-U4Z reader is equipped with anti-collision feature, which enable two readers placed closely to each other and operate with 100% distance.

To readers operate as anti-collision units, connect the terminals no.1 of these readers.

13. Command description:

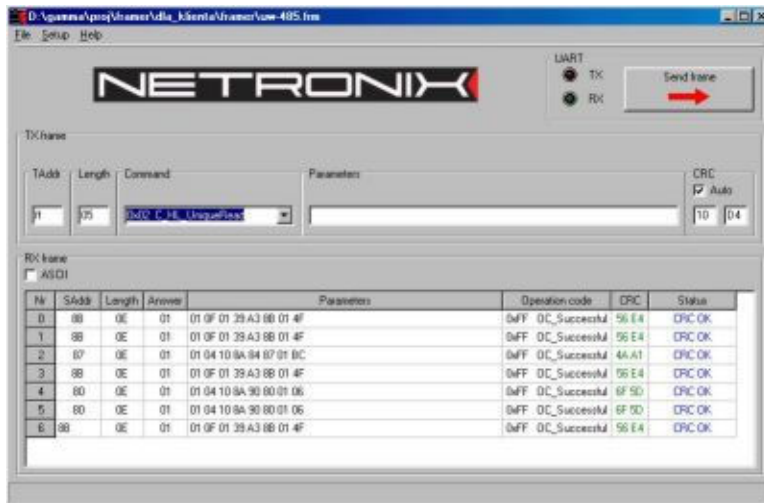

Module can be tested with FRAMER software tool, which makes work with frames easier.

13.1. Read-out of the Unique transponder

Name of command – query	Command code	Parameters
C_UniqueRead	0x02	-

Command reads-out of transponder ID.

Name of command – response	Response code	Parameters
A_UniqueRead	0x03	ID1...5, OperationCode

ID1...5 – ID-UNIQUE number which is programmed for Q5 or UNIQUE transponder.
 OperationCode – when = 0xff-read-out is correct (Unique control sum has been checked).

13.2. Driving the buzzer and relay

Name of command – query	Command code	Parameters
C_WriteOutputs	0x70	Dest, Value

Dest – suitable bits choose the target element, the younger bit defines the buzzer and the older bit defines the relay.

For Dest=0 – the status of any element won't be changed

For Dest=1 – we refer to buzzer only

For Dest=2 – we refer to relay only

For Dest=3 – we refer to buzzer and relay

Value – suitable bits define new states of the elements chosen in Dest, the younger bits refers to the buzzer and the older bit than previous refers to the relay.

For Value=0 – the forced states - switching off the buzzer and relay.

For Value=1 – the forced states - switching on the buzzer and switching off the relay.

For Value=2 – the forced states - switching off the buzzer and switching on the relay.

For Value=3 – the forced states – switching on the buzzer and relay.

Owing to bit combination, we can change the status of the any element, with one command.

Name of command – query	Command code	Parameters
A_WriteOutputs	0x71	OperationCode

OperationCode - 0xff- read-out is correct

13.3. Read-out of the push-button status

Name of command – query	Command code	Parameters
C_ReadButton	72	-

Name of command – response	Response code	Parameters
A_ReadButton	73	Button, OperationCode

OperationCode - 0xff- read-out is correct

This command reads the bush button status, which is located in the reader housing on front panel. The reader memorizes the push-button switching for 0.5 s.

If Button=0 – the push-button has not been switched during the last 500 ms.

If Button=1 – the push-button has been switched during the last 500 ms.

13.4. Reading of card ID from reader memory

Name of command – query	Command code	Parameters
C_CardRead	0x20	PositionHL

PositionHL=(0x0000...0x03f1) – the card position in memory

Positions within (0x0000...0x03e7) are dedicated for the “access cards”

Positions within (0x03e8...0x03f1) are dedicated for the “master cards”

Name of command – response	Response code	Parameters
A_CardRead	0x21	ID1...5, OperationCode

ID1...5 – the card ID number read-out from „PositionHL” position

OperationCode - 0xff- read-out is correct

13.5. Writing of card ID to reader memory

Name of command – query	Command code	Parameters
C_CardWrite	0x22	ID1...5, PositionHL

ID1...5 – ID, which we want to write on „PositionHL” position

PositionHL=(0x0001...0x03f1) - is card position in memory

Positions within (0x0000...0x03e7) are dedicated to the “access cards”

Positions within (0x03e8...0x03f1) are dedicated to the “master cards”

Name of command – response	Response code	Parameters
A_CardWrite	0x23	OperationCode

OperationCode - 0xff- write is correct

13.6. On and off reader memory

Turn on or turn off finding in memory card of read out card

Name of command – query	Command code	Parameters
C_CheckCardMemory	0x2a	OnOff

OnOff =1 memory card will be checking

OnOff =0 memory card will not be checking

Name of command – response	Response code	Parameters
A_CheckCardMemory	0x2b	OperationCode

13.7. Logging to the reader

Logging on should be performed in case a user, he wants to use one of these commands: C_CardRead, C_CardWrite, C_DevParamSet.

Logging out is performed automatically after 30 s from the last correct using one of these commands: C_Password, C_CardRead, C_CardWrite.

After receiving the correct C_DevParamSet command, the reader is reset automatically and begins to operate with new settings.

In case a user does not have a password, he can use the C_ResetCardMemory command.

Name of command – query	Command code	Parameters
C_Password	0x24	P1...P5

P1...P5- five dot password

Name of command – response	Response code	Parameters
A_Password	0x25	OperationCode

OperationCode – 0xff- a user has been logged in (the given password P1...P5 was correct)

13.8. Changing the password

This command changes the set password in the reader for a new one. A user can use this password logging in to the reader in future.

Name of command – query	Command code	Parameters
C_ChangePasword	0x26	P1...5, NewP1...5

P1...5 – five dots of the old password

NewP1...5 – five dots of the new password

Name of command – response	Response code	Parameters
A_ChangePasword	0x27	OperationCode

OperationCode – 0xff - the operation is correct

13.9. Forcing the default settings

This command removes all cards from memory and sets standard password „1 2 3 4 5”.

Name of command – query	Command code	Parameters
C_ResetCardMemory	0x28	String

where String=0x72 0x65 0x73 0x65 0x00 (ASCII: “reset”)

Name of command – response	Response code	Parameters
A_ResetCardMemory	0x29	OperationCode

OperationCode –0xff – the operation has been performed correctly

To perform this command, delete all the reader memory. It is the reason why this the one of the longest performed commands - ca. 5 s.

13.10. Changing the reader configuration

Name of command – query	Command code	Parameters
C_DevParamSet	0x34	B1...B5

B1...B5 – five configuration bites (configuration word)

Name of command – response	Response code	Parameters
A_DevParamSet	0x35	OperationCode

OperationCode – 0xff - the configuration word has been set correctly

Meaning of the bits in the configuration word:

B1

MSB						LSB	
						G1	G0
reserve for future use						reader gain	

G1 G0 – define the receiver circuit gain reading the ID of the transponder.

00 – lowest gain

11- highest gain

Default value: 11

B2

MSB				LSB			
	UR0	B10	S10	S3	S2	S1	S0
reserve for future use	Uart repeat	base ID uart send	some ID uart send	uart speed			

S3 S2 S1 S0 – The UART baud rate

0000 – 1200 bps

0001 – 2400 bps

0010 – 4800 bps

0011 – 9600 bps

0100 – 19200 bps

0101 - 38400 bps

0110 – 57600 bps

0111 – 115200 bps

Default value:0011

S10 – In case a transponder is in reader field all the time, this bit determines if the any red ID is to be sent via UART interface.

0 – Any red ID won't be sent

1 – Any red ID will be sent

Default value:0

B10 - In case a transponder is in reader field all the time, this bit determines if the red ID, which is internal ID base is to be sent via UART interface.

0 – The read ID though it is in base, won't be sent

1 - The read ID though it is in base, will be sent

Default value:0

UR0 – In case the reader is trying to read the transponder repeatedly and a transponder is in reader field all the time, this bit determines if the being red ID, will be sent cyclically via UART interface.

0 – ID will be sent one time only – when the card is applied

1 - ID will be sent repeatedly up to the moment of card removing

Default value:0

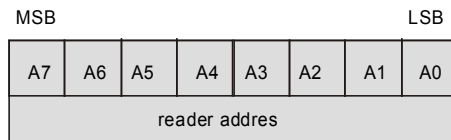
B3

A7...A0 – defines the reader logic address on the RS-485 bus

00000001- address = 0x01
 00000010- address = 0x02
 00000011- address = 0x03

 11111110- address = 0xfe
 Default value:00000001

We can assign the addresses within 0x01 ... 0xfe range to the readers.

Depending on address used, we can get the response from the reader (selective addressing) or from readers one by one (group addressing)

To configure a reader network, set the unique address (B3) for any reader, before connecting it to the common RS bus first. If there are the same addresses in one network, it won't be possible to refer to the network readers.

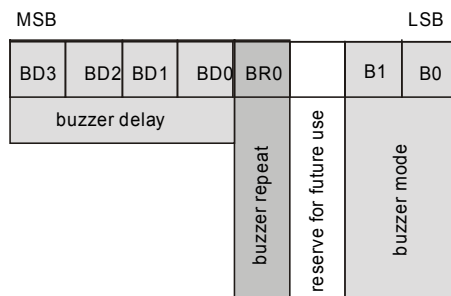
B4

B1 B0 – In case the reader is trying to read the transponder repeatedly and a transponder is in reader field all the time, these bits determine the internal buzzer behavior.

00 – buzzer responses for any red-out card
 01 – buzzer responses for any red-out card, but for such the card, which ID is in internal card base
 10 – buzzer does not responses for any card

Apart from buzzer mode, it is always possible to use the C_WriteOutputs command to switch the buzzer on.
 Default value:00

BR0 - In case the reader is trying to read the transponder repeatedly and a card appears in the field, this bit determines if the buzzer is to operate repeatedly or one time only.

0- buzzer sounds one time only, when card is applied
 1- buzzer will sound repeatedly up to the moment of card removing.

Default value:0

BD3 BD2 BD1 BD0 – determines the operation time of the buzzer, after the actuating means appear. The hold time of the buzzer can be determined with the formula:

$T_b = (2 * BD - 1) * 100$ where T_b is in [ms]. This formula is true for $BD = (0x1...0xe)$. For the $BD = 0x0$ value, the buzzer does not operate because of other reasons. For the $BD = 0xf$ value, the buzzer does not switch off spontaneously. (We can drive the buzzer with the C_WriteOutputs command).

0000 – 0 ms (buzzer does not operate)

0001 - 100 ms

0010 - 300 ms

0011 - 500 ms

.....

1110 - 2700 ms

1111 - the buzzer does not switch off spontaneously

Default value:0001

B5

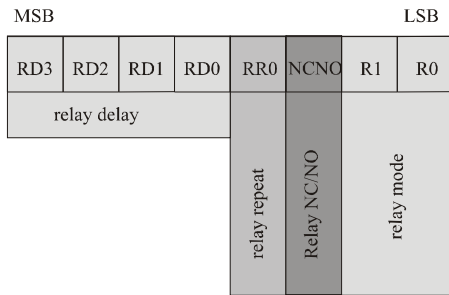

R1 R0 – In case a card is in reader field all the time, these bits determine the relay behavior.

- 00 – relay responses relay responses for any red-out card
- 01 – relay responses for the red-out card, but such card, which ID is internal card base
- 10 – relay does not respond for any card

Apart from relay mode, we can always use the C_WriteOutputs command, to switch the relay on.
Default value:01

NCNO

Relay configuration like Normal Open or Normal Connect
0- NO
1- NC
Default value:0

RR0 – n a card is in reader field all the time, these bits determine if the relay is to operate repeatedly or one time only.
0- relay will operate one time only, when card is applied
1- relay will operate repeatedly up to the moment of card removing.
Default value:1

RD3 RD2 RD1 RD0 – determines the operation time of the relay, after the actuating means appear. The hold time of the relay can be determined with the formula:

$Tb = (2 * RD - 1) * 100$ – where Tb is in [ms]. This formula is true for $BD = (0x1...0xe)$ value. For the $BD = 0x0$ value, the relay will not operate, because of other reasons. For the $BD = 0xf$ value, the relay does not switch off spontaneously (We can drive the relay with the C_WriteOutputs command).

0000 – 0 ms (relay will not operate)

0001 - 100 ms

0010 - 300 ms

0011 - 500 ms

.....

1110 - 2700 ms

1111 - will not switch off spontaneously

Default value:0111

13.10.1. Configuration examples

13.10.1.1. Default configuration

Reader operates as autonomous, but we can send any command to it at any time Default password: „12345”				
B1	B2	B3	B4	B5
Read-outs of the transponder with the highest analog path gain.	In case of the transponder is applied, any received ID is sent repeatedly via RS interface. Baud rate: 9600 bps	Address 0x01	Hold time of the buzzer operation: 100 ms (short beep). One time operation when any card is red-out.	Hold time of relay operation: 2,6 s (time to enter). Repeatedly operation, when card is red, which is written in memory.
x x x x x x 1 1	x 1 0 1 0 0 1 1	0 0 0 0 0 0 0 1	0 0 0 1 0 x 0 0	1 1 1 1 1 0 0 1

13.10.1.2. Configuration the reader to operate on control of master system only

Reader does not read transponders by itself and we can send the command to it at any time				
B1	B2	B3	B4	B5
Read-outs of the transponder with the lowest analog path gain.	Four oldest bits concern to autonomous mode, so in that case they are invalid. Baud rate: 9600 bps	Address 0x01	Hold time of the buzzer operation: 100ms (short beep). Buzzer operates at the moment of receiving the suitable command only.	Hold time of the relay operation: 2,6 sec (time to enter). Relay operates at the moment of receiving the suitable command only.
x x x x x x 0 0	x x x x 0 0 1 1	0 0 0 0 0 0 0 1	0 0 0 1 x x 1 0	1 1 1 1 x x 1 0

13.11. Read-out of the UW-U4Z reader software version

Name of command – query	Command code	Parameters
C_SoftwareVersion	0xfe	-

Name of command – response	Response code	Parameters
A_SoftwareVersion	0xff	Dane1...n, OperationCode

Dane1...n – Software version written in ASCII code

OperationCode – 0xff only

14. Operation codes sent back by reader

On the whole, the operation code of 0xff value means correct command execution, but there are some other codes, which depend on circumstances.

Error name	Error code	Meaning
OC_ParityError	0x1a	parity error
OC_RangeError	0x20	overrange
OC_LengthError	0x21	wrong length (data volume)
OC_NoACKFromSlave	0x22	no internal circuit response
OC_Error	0xfe	error
OC_WrongPassword	0x30	wrong password
OC_Successful	0xff	operation done successfully

15. Examples of the UW-U4Z reader operation

15.1. Access control function

Assumptions:

Assume that, we have three readers at disposal, which we want to operate.

To operate the readers, assign them addresses: 0x01, 0x02, 0x03 and connect them and master unit (e.g. PC) to RS bus (e.g. is described in chapter „The diagram of connections of two readers system”).

Readers configuration can be optional, but it has to take on account suitable data baud rate.

We send the string to the UW-U4Z (group addressing):

module address	frame length	command	data	CRCH,CRCL
ff	05	02	-	XX XX

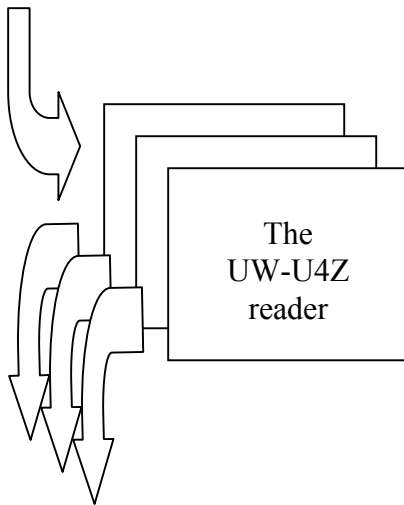

We receive the following responses:

module address	frame length	command	data	operation code	CRCH,CRCL
01	06	03	xx xx xx xx xx	1A	XX XX
02	0b	03	a1 35 f6 71 ea	ff	XX XX
03	06	03	E5 75 86 21 15	ff	XX XX

As we can easily find out from the received responses, the readers with 0x02 and 0x03 addresses red-out the card ID's correctly. Let assume, that master unit which performs decision function knows red-out ID's. It means, that this unit should send the open door commands, to the doors, at which the readers are located and which have been red-out by the transponders.

The lock door commands should be sent to the reader 0x02, and then to the 0x03 reader one by one.

To the UW-U4Z module with the 0x02 address (selective addressing) we send the string:

module address	frame length	command	data	CRCH,CRCL
02	05	70	02 02	XX XX



Contents of the “data” field means that relay (first byte) has been chosen for writing and it should be switched on (second byte).

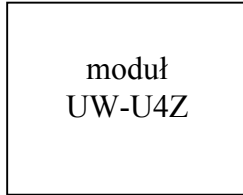

We receive one response only:

module address	frame length	command	data	operation code	CRCH,CRCL
02	0b	71	-	ff	XX XX

The proper response is – door has been open.

Next we send the string to the UW-U4Z module with the 0x03 address (selective addressing):

module address	frame length	command	data	CRCH,CRCL
03	05	70	02 02	XX XX

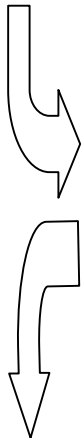

Contents of the “data” field means that relay (first byte) has been chosen for writing and it should be switched on (second byte).

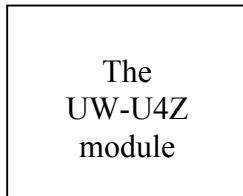

We receive one response only:

module address	frame length	command	data	operation code	CRCH,CRCL
03	0b	71	-	ff	XX XX

The proper response is – door has been open.

Repeating that cycle constantly: cards read-out – decisions – switching the locks, we can get effect of fluent system operation.

15.2. Writing the ID as a "master" card

Assumptions:

Assume that, we have three readers at disposal, which we want to operate.

To operate the readers, assign them addresses: 0x01, 0x02, 0x03 and connect them and master unit (e.g. PC) to RS bus (e.g. is described in chapter „The diagram of connections of two readers system”).

Readers configuration can be optional, but it has to take on account suitable data baud rate.

Assume that, we have a transponder with the 0x11 22 33 44 55 number. We want to assign its number to every reader, so to get this transponder to operate as a “master” unit and with the help of that unit to add or/and remove other cards and without using RS network.

To write a card, we have to logging to the every reader first.

We send the string to the UW-U4Z module (group addressing):

module address	frame length	command	data	CRCH,CRCL
ff	0A	24	01 02 03 04 05	XX XX

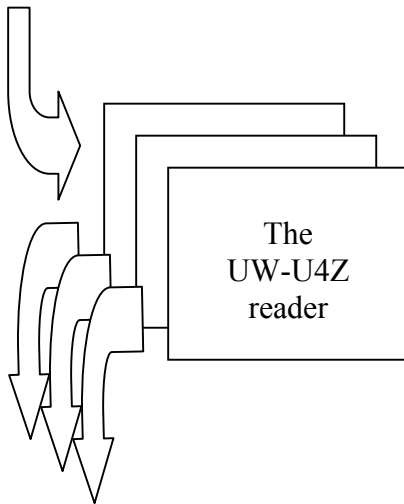

We receive the following responses:

module address	frame length	command	data	operation code	CRCH,CRCL
01	06	25	-	ff	XX XX
02	0b	25	-	ff	XX XX
03	06	25	-	ff	XX XX

All readers responded correctly – we are logged in them.

Now the ID writing operating to the readers should be performed. The card with the 0x 11 22 33 44 55 number will function as a “master” card, if it is written on any position within the 0x03e8 ... 0x03f1 range only.

We send the string to the UW-U4Z modules (group addressing):

module address	frame length	command	data	CRCH,CRCL
ff	0C	22	F4 01 11 22 33 44 55	XX XX

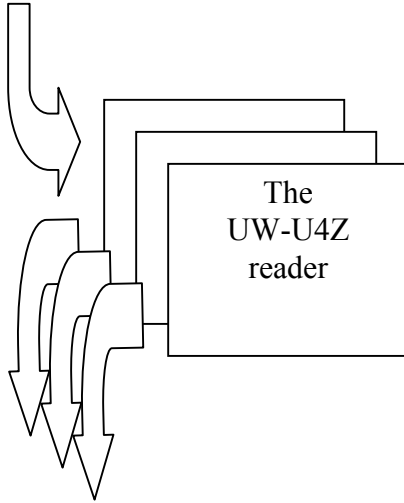

We receive the following responses:

module address	frame length	command	data	operation code	CRCH,CRCL
01	06	23	-	ff	XX XX
02	0b	23	-	ff	XX XX
03	06	23	-	ff	XX XX

All readers responded correctly – ID is written.

Now to check if our card functions as a “master”, apply it to the reader (two short beeps), and then apply other card to the reader (the adding card or removing card sound). Hence the reader memorizes the new card and doesn’t need continuous operation of “master-decision” system to accomplish access control function.

When because of any reason, a user needs to remove the “master” card from reader memory, he can do it with the help of the same command as above, but he should use selective addressing to it.

Let say, we want to remove “master” card from the reader with the 0x01 address.

We send the string to the UW-U4Z module with 0x02 address (selective addressing):

module address	frame length	command	data	CRCH,CRCL
01	05	22	F4 01 ff ff ff ff ff	XX XX

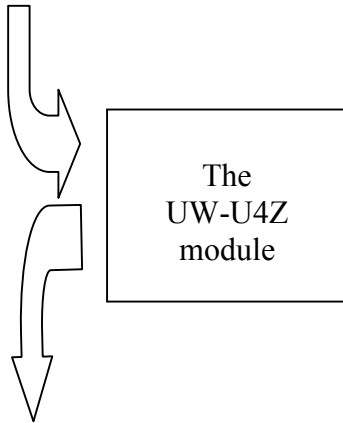

Contents of the "data" field means that the data of previously registered card will be replaced with 0xff value. The "master" card will be removed.

We receive one response only:

module address	frame length	command	data	operation code	CRCH,CRCL
01	0b	23	-	ff	XX XX

The response is correct - the card is removed from memory

15.3. Writing the ID as a „access control” card

Assumptions:

Assume that, we have three readers at disposal, which we want to operate.

Assume that, we have a transponder with 0xaa bb cc dd ee number and want to place its number into every reader, so the transponder will function as a "access control" card. There are two ways of doing that.

15.3.1. Writing via RS-485 bus

To write a card remotely, we have to act the same way as mentioned in section "Writing the ID as a "master" card". Only difference is, that our card will be written on any position within the 0x0000 to 0x03e7 range.

15.3.2. Writing with the help of "master" card

If we have a card, which has been written as a "master" earlier e.g. as it described in section "Writing the ID as a "master", we can memorize in the reader any card which has not been registered before.

To do that, apply the "master" card to the reader. Twice beep means, that the reader recognized the card as a "master", and now it waits for other card applying.

If this card is not registered, hence it will be recognized by the reader.

If applied card has been registered before as a "access control" card, it will be removed from memory.

The same operation should be performed on every reader, which is to connect in network.

Latest news on **NETRONIX** products:
<http://www.netronix.pl/>