



















# 7 MULTI CONNECTION SYSTEM **MIDI**

## Female Connectors with Solder Pins, Pin Spacing 5.08 mm / 0.2 in





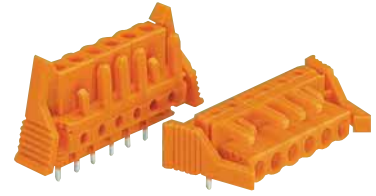
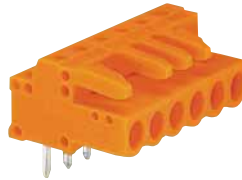
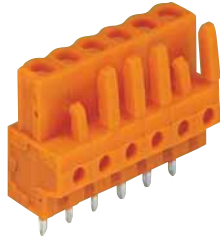

36

<b>Pin spacing 5.08 mm/0.2 in, orange</b> 250 V/4 kV/3   300 V, 15 A  12 A   300 V, 15 A 	<b>Pin spacing 5.08 mm/0.2 in, orange</b> 250 V/4 kV/3   300 V, 15 A  12 A   300 V, 15 A 	<b>Female connectors with solder pins and locking device</b>
*        	*       	



No. of poles	Item No.	No. of poles	Item No.	Additional item No. for . . .
<b>Female connectors with straight solder pins,</b> with coding fingers, with two latches, orange, solder pin 0.6 mm x 1 mm		<b>Female connectors with right angle solder pins,</b> with coding fingers, with two latches, orange, solder pin 0.6 mm x 1 mm		. . . Female connectors with straight or right angle solder pins and <b>locking device</b>
2 (one latch only)	<b>232-162</b>	2 (one latch only)	<b>232-262</b>	. . . /039-000
3 (one latch only)	<b>232-163</b>	3 (one latch only)	<b>232-263</b>	
4	<b>232-164</b>	4	<b>232-264</b>	
5	<b>232-165</b>	5	<b>232-265</b>	
:	:	:	:	
:	:	:	:	
12	<b>232-172</b>	12	<b>232-272</b>	
:	:	:	:	
:	:	:	:	Ordering example:
21	<b>232-181</b>	21	<b>232-281</b>	Female connector with right angle solder pins and locking device, pin spacing 5.08 mm/0.2 in, orange,
22	<b>232-182</b>	22	<b>232-282</b>	10-pole <b>232-270/039-000</b>
23	<b>232-183</b>	23	<b>232-283</b>	
24	<b>232-184</b>	24	<b>232-284</b>	

### Accessories

	<b>Test plug, w. cable 500 mm/1'7.7"</b> 2 mm/0.079 in Ø, red <b>210-136</b> 2.3 mm/0.091 in Ø, yel. <b>210-137</b>		<b>Test plug, w. cable 500 mm/1'7.7"</b> 2 mm/0.079 in Ø, red <b>210-136</b> 2.3 mm/0.091 in Ø, yel. <b>210-137</b>		<b>Test plug, w. cable 500 mm/1'7.7"</b> 2 mm/0.079 in Ø, red <b>210-136</b> 2.3 mm/0.091 in Ø, yel. <b>210-137</b>
	<b>Marker strips, self-adhesive</b> 1-12 (200 x) <b>210-331/0508-0103</b> 13-24 (200 x) <b>210-331/0508-0104</b>		<b>Marker strips, self-adhesive</b> 1-12 (200 x) <b>210-331/0508-0103</b> 13-24 (200 x) <b>210-331/0508-0104</b>		<b>Marker strips, self-adhesive</b> 1-12 (200 x) <b>210-331/0508-0103</b> 13-24 (200 x) <b>210-331/0508-0104</b>

### Dimensions (in mm)

Diameter of drilled hole: 1.3<sup>+0.1</sup>mm

① Distance to the first solder pin see diagram on the left

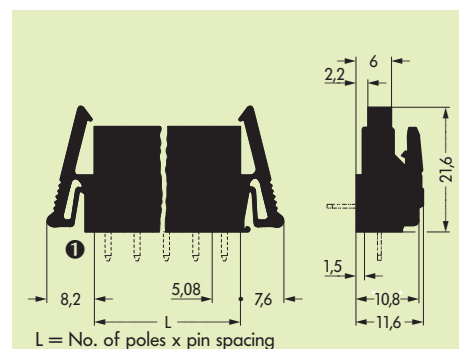
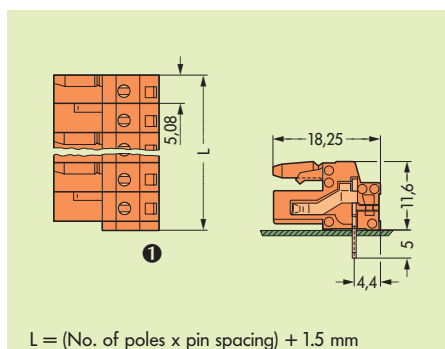
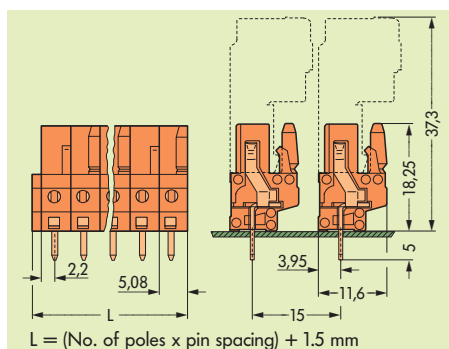

\* Approvals with corresponding ratings see pages 12.3 ff.