

**ebm-papst St. Georgen GmbH & Co. KG**

Hermann-Papst-Straße 1

D-78112 St. Georgen

Phone +49 7724 81-0

Fax +49 7724 81-1309

info2@de.ebmpapst.com

www.ebmpapst.com

**Nominal data**

Type	8318	
Nominal voltage	VDC	48
Nominal voltage range	VDC	36 .. 56
Speed	min <sup>-1</sup>	3300
Power input	W	2.6
Min. ambient temperature	°C	-20
Max. ambient temperature	°C	75
Air flow	m <sup>3</sup> /h	54
Sound power level	B	5.2
Sound pressure level	dB(A)	36

ml = max. load · me = max. efficiency · rfa = running at free air · cs = customer specs · cu = customer unit  
Subject to alterations

## Technical features

<b>Dimensions</b>	80 x 80 x 32 mm
<b>General description</b>	<p>Particular design features:  Optional Vario-Pro: Highly flexible software configuration for the fan ensures an easily customisable solution to meet the individual requirements of your application.</p> <p>General features:  Material: fibreglass-reinforced plastic. Impeller PA, housing PBTP.  Electronic commutation completely integrated.  Protected against reverse polarity and locking.  Connection via single strands AWG 22, TR 64, bared and tin-plated.  Air exhaust over bars. Rotational direction clockwise looking at rotor.  Mass: 170 g.</p>
<b>Connection line</b>	Single strands AWG 22, TR 64, bared and tin-plated.
<b>Locked-rotor protection</b>	Blocking and overload protection
<b>Direction of rotation</b>	Right, looking at rotor
<b>Direction of air flow</b>	Air exhaust over bars
<b>Bearing</b>	Ball bearings
<b>Lifetime L10 at 40 °C</b>	70000 h
<b>Lifetime L10 at maximum temperature</b>	27500 h
<b>Mass</b>	0.170 kg
<b>Housing material</b>	Fiberglass-reinforced PBT plastic
<b>Material of impeller</b>	Fiberglass-reinforced PA plastic
<b>Motor protection</b>	Protected against reverse polarity and locking.
<b>Approval</b>	VDE, CSA, UL, CE

## Product drawing

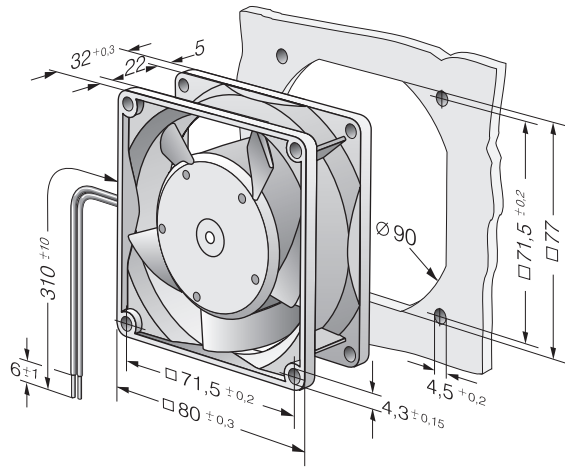

## Charts: Air flow

