

# SERIES 1840 - SINGLE AND DOUBLE-POLE PUSHBUTTON SWITCHES

TO 6 (4) A 250 V AC





## PRODUCT FEATURES

- ◆ 100 million times proven switching principle with longer life endurance with 100 000 mechanical switching cycles
- ◆ Fastening by round nut M12
- ◆ Excellent actuating characteristic
- ◆ Variant for snapping on customized pushbuttons

## ON REQUEST

- ◆ Higher power with 6 (6) A 250 V AC
- ◆ Other terminal types
- ◆ Cable assembly

Mechanical life endurance	10E4
Contact resistance (new condition)	< 100 mOhm (1 A 12 V DC)
Insulation resistance (new condition)	> 100 MOhm (500 V DC)
Proof tracking	250 PTI
Protection type	IP 40
Ambient temperature	terminal side -20 °C ... +100 °C actuating side -20 °C ... +55 °C
Flammability	UL 94 V-2
Glow wire test temperature	850 °C
Material	actuator PA housing PA glass fiber-reinforced / PA terminals silver plated
Plug force of the terminals	≤ 80 N
Approval marks	 /  / 
Suitable for appliances of protection class II	



ROCKER SWITCHES

PUSHBUTTON SWITCHES

TOGGLE SWITCHES

SLIDE SWITCHES

ROTARY SWITCHES

FOOT SWITCHES

FACT AND KEY SWITCHES



























SNAP-ACTION SWITCHES

MICRO-SIGNAL SWITCHES

SENSORS

# SERIES 1840 - SINGLE AND DOUBLE-POLE PUSHBUTTON SWITCHES

TO 6 (4) A 250 V AC

 single-pole	Actuator color / printing	Housing color	6 (4) A 250 V AC 5E4	6 (2) A 250 V AC 5E4	6 A 250 V AC 1/2 HP	6 A 125 V AC 1/4 HP	6 A 125 - 250 V AC 1/8 HP	Terminal type	Terminal description	Contact distance in mm	Contact material	Miscellaneous	Stock version
<b>ON / OFF switch (SPST)</b>													
1841.1101			•		•	•			4.8	≥ 3	Ag		•
1841.6101			•		•	•			4.8	≥ 3	Ag	snap-on actuator caps see page 105	
<b>Normally closed contact (SPNC)</b>													
1841.1301				•			•		4.8	≥ 3	Ag		•
<b>Normally open contact (SPNO)</b>													
1841.1201				•			•		4.8	≥ 3	Ag		•
<b>Changeover switch (SPDT)</b>													
1843.1101			•		•	•			4.8	≥ 3	Ag		
<b>Changeover switch (SPDT momentary)</b>													
1843.1201				•			•		4.8	≥ 3	Ag		•
 double-pole	Actuator color / printing	Housing color	6 (4) A 250 V AC 5E4	6 (2) A 250 V AC 5E4	6 A 250 V AC 1/2 HP	6 A 125 V AC 1/4 HP	6 A 125 - 250 V AC 1/8 HP	Terminal type	Terminal description	Contact distance in mm	Contact material	Miscellaneous	Stock version
<b>ON / OFF switch (DPST)</b>													
1842.1101			•		•	•			4.8	≥ 3	Ag		
1842.6101			•		•	•			4.8	≥ 3	Ag	snap-on actuator caps see page 105	

ROCKER SWITCHES

PUSHBUTTON SWITCHES

TOGGLE SWITCHES

SLIDE SWITCHES

ROTARY SWITCHES

FOOT SWITCHES

FACT AND KEY SWITCHES

SNAP-ACTION SWITCHES

MICRO-SIGNAL SWITCHES

SENSORS

# SERIES 1840 - SINGLE AND DOUBLE-POLE PUSHBUTTON SWITCHES

TO 6 (4) A 250 V AC



Basic types 1841 and 1843  
single-pole

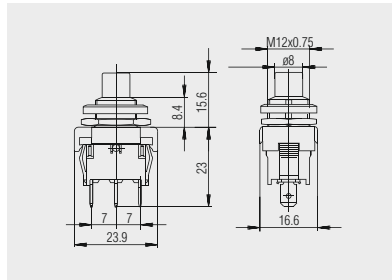

Quick-connect terminal  
4.8 x 0.8



Basic type 1842  
double-pole

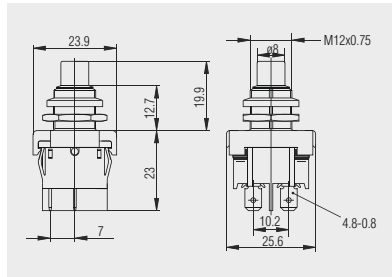

Quick-connect terminal  
4.8 x 0.8



Identification plate  
240.001.011

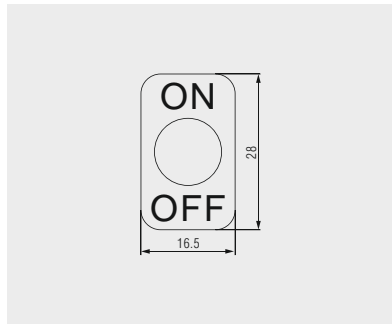

Identification plate of aluminum for plugging on with black inscription "ON" and "OFF"



Identification plate  
240.002.011

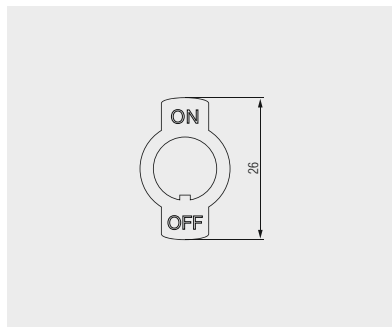

Identification plate of CuZn nickel-plated for plugging on as well as with twist protection and stamped inscription "ON" and "OFF"



Protection cap  
343.002.023

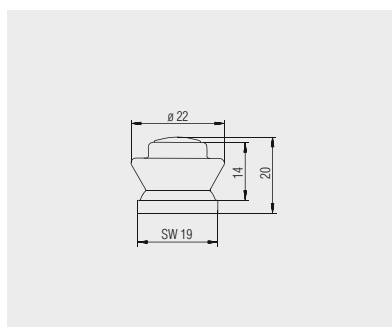

Neopren® - cap for pushbutton (M12 x 0.75) basic type 1840 as dust and water protection. Pushbutton plate on top of cap is CuZn nickel plated.

ROCKER SWITCHES

PUSHBUTTON SWITCHES

TOGGLE SWITCHES

SLIDE SWITCHES

ROTARY SWITCHES

FOOT SWITCHES

FACT AND KEY SWITCHES

SNAP-ACTION SWITCHES

MICRO-SIGNAL SWITCHES

SENSORS

# SERIES 1840 - SINGLE AND DOUBLE-POLE PUSHBUTTON SWITCHES

TO 6 (4) A 250 V AC

ROCKER SWITCHES

PUSHBUTTON SWITCHES

TOGGLE SWITCHES

SLIDE SWITCHES

ROTARY SWITCHES

FOOT SWITCHES

TACT AND KEY SWITCHES

SNAP-ACTION SWITCHES

MICRO-SIGNAL SWITCHES

SENSORS



Pushbutton  
205.008.011

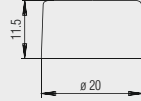

Pushbutton of PA black, with diameter 20 mm for assembly by customer on 1841.6101 and 1842.6101



Pushbutton  
203.106.011

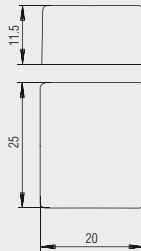

Pushbutton of PA black, rectangular 20 x 25 mm for assembly by customer on 1841.6101 and 1842.6101