

THIS DOCUMENT IS THE PROPERTY OF  
KEYSTONE ELECTRONICS CORP. AND  
SHALL NOT BE REPRODUCED, DISTRIBUTED  
OR USED AS A BASIS FOR MANUFACTURE  
WITHOUT PRIOR WRITTEN PERMISSION  
FROM KEYSTONE ELECTRONICS CORP.

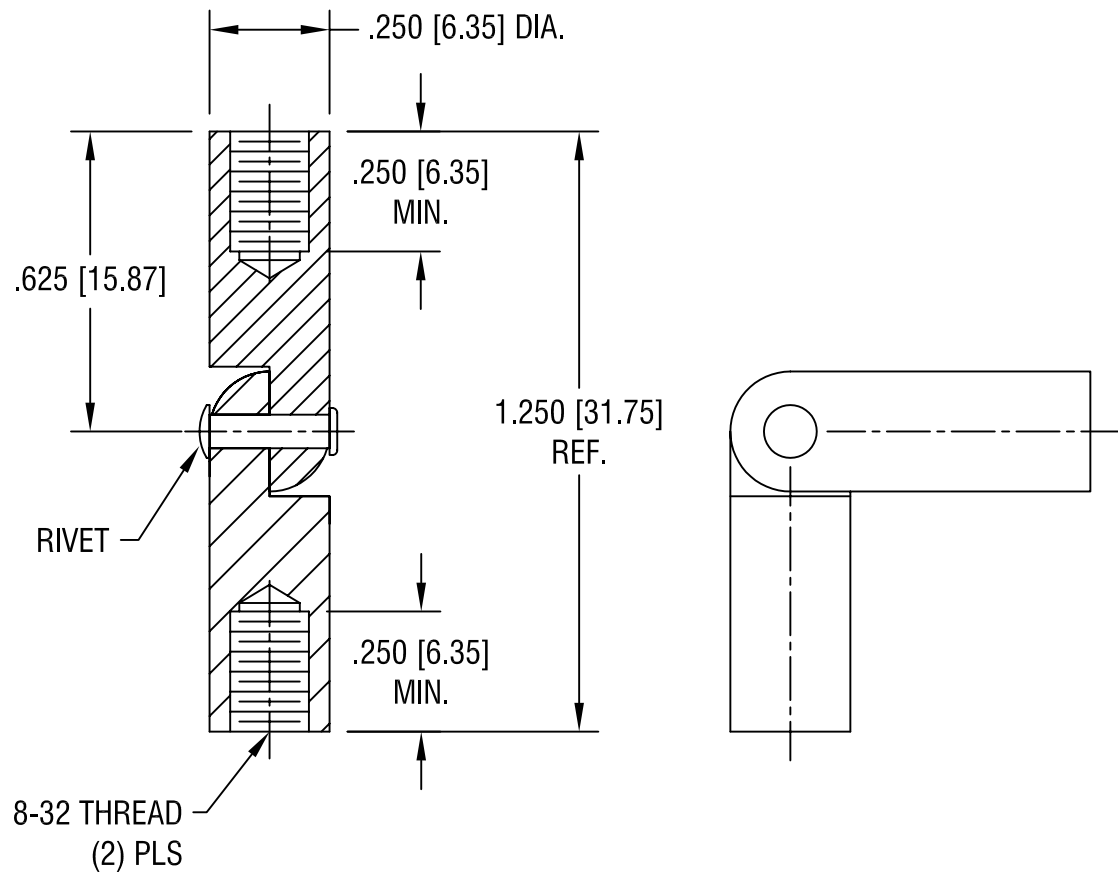

**KEYSTONE ELECTRONICS CORP.**

ASTORIA, N.Y. 11105-2017

PART NAME

HINGED STANDOFF, FEMALE/FEMALE

MATERIAL

BRASS

FINISH

ZINC PLATE  
GOLD IRIDITE

DRN BY

BOONE

DATE

9.18.95

APP'D

SCALE

3X

TOLERANCES

INCH [MM]

DECIMAL  $\pm .005$  [ $\pm 0.15$ ]

ANGULAR  $\pm 1^\circ$   
UNLESS OTHERWISE SPECIFIED

CODE

C/M

DWG NO.

332

DATE

DESCRIPTION

REV.