



Board-to-Board Link; Pin spacing 4 mm; 2-pole; Length: 28 mm

Item No.: 2060-952/028-000



Board-to-Board Link; Pin spacing 4 mm; 2-pole; Length: 28 mm

Marking

RoHS ✓
Compliant

Business data

Supplier	WAGO
Item no.	2060-952/028-000
GTIN / EAN	4055143303859
Content	1
Order amount	500
Customer item number	

Notes

Item description: Board-to-board link simplifies in-line assembly of LED modules Easy push-in termination and disconnection without push-button actuation Recommendation: Only suitable for 2060-45x, not for 2060-40x.

Technical data

Miscellaneous

No. of poles	2
Pin spacing	4 mm (0.157 in)
Total number of potentials	2
Color	white
Ratings per	IEC/EN 60664-1

Technical data	
<i>Rated voltage (III / 3) [V]</i>	<i>63 [V]</i>
<i>Rated impulse voltage (III / 3) [kV]</i>	<i>2.5 [kV]</i>
<i>Rated voltage (III/2) [V]</i>	<i>160 [V]</i>
<i>Rated impulse voltage (III / 2) [kV]</i>	<i>2.5 [kV]</i>
<i>Rated voltage (II / 2) [V]</i>	<i>320 [V]</i>
<i>Rated impulse voltage (II / 2) [kV]</i>	<i>2.5 [kV]</i>
<i>Rated current [A]</i>	<i>9 [A]</i>
<i>Rated current (2) [A]</i>	<i>9 [A]</i>
<i>Rated current (3) [A]</i>	<i>9 [A]</i>
<i>Material group</i>	<i>I</i>
<i>Insulating material</i>	<i>Polyamide 66 (PA 66)</i>
<i>Flammability class per UL94</i>	<i>V0</i>
<i>Limit temperature range</i>	<i>-60 ... 105 C</i>
<i>Contact material</i>	<i>Copper alloy</i>
<i>Contact plating</i>	<i>Silver-plated</i>
<i>Weight [g]</i>	<i>0.46 [g]</i>
<i>Width</i>	<i>7.4 mm / 0.291 in.</i>
<i>Height</i>	<i>2.6 mm / 0.102 in.</i>
<i>Depth</i>	<i>28 mm / 1.102 in.</i>

Images & drawings

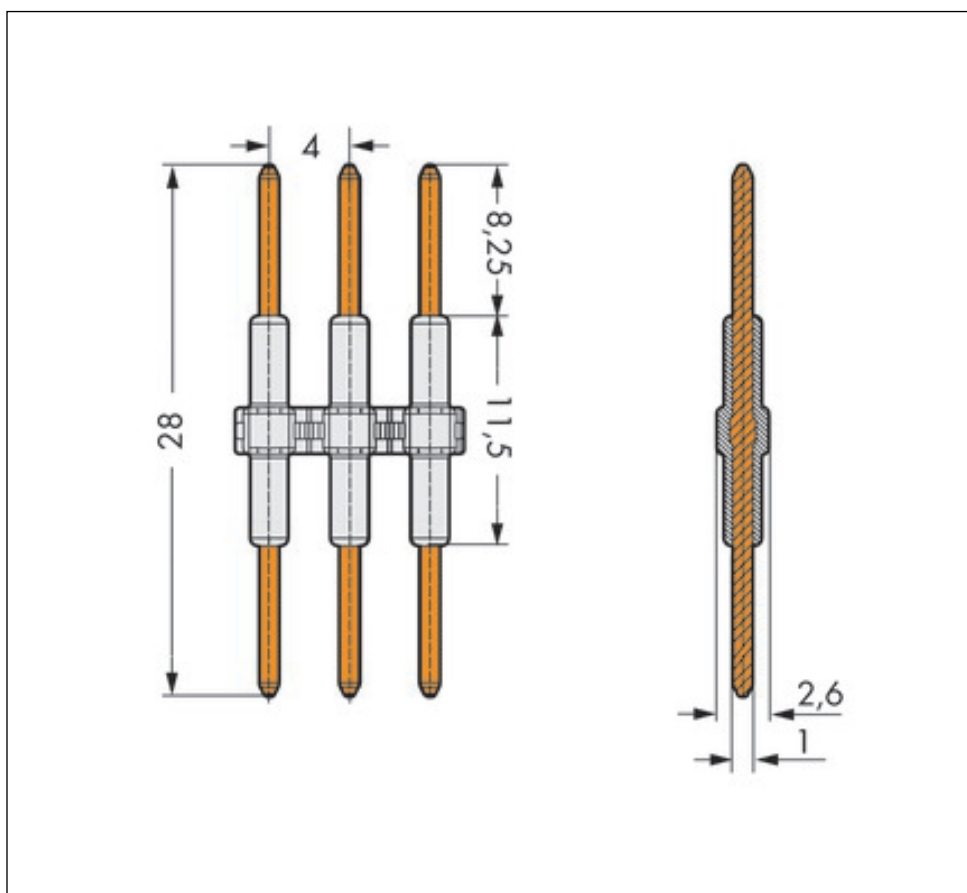
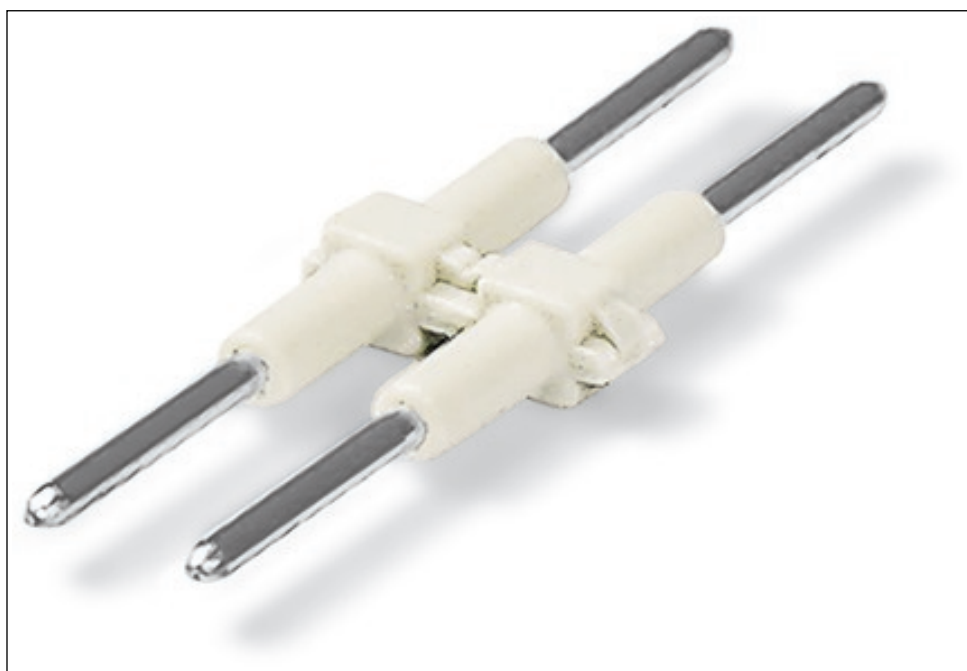

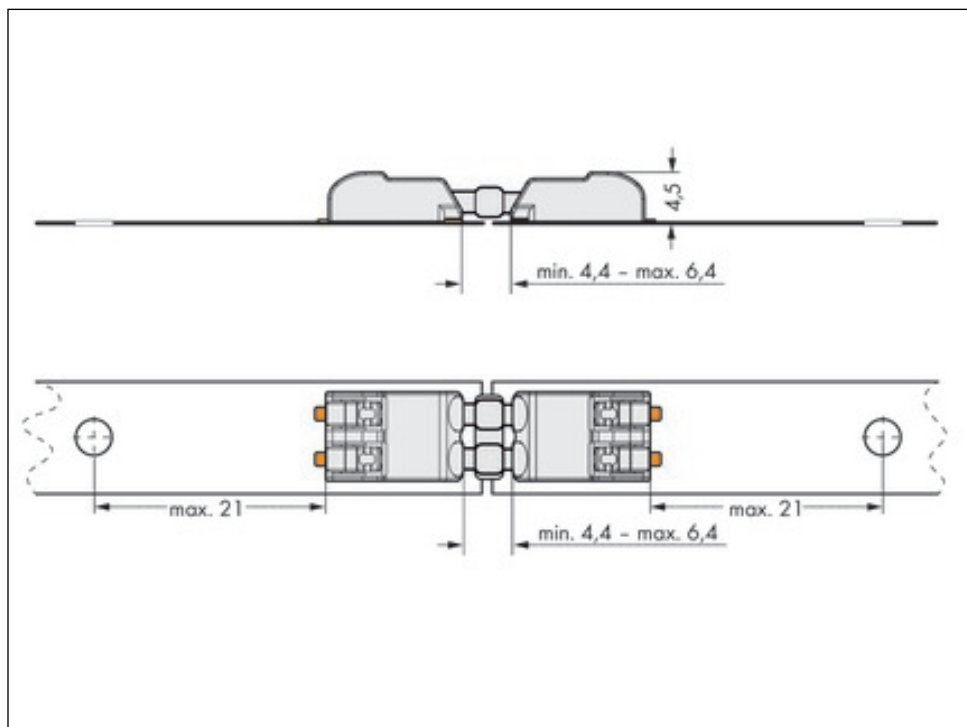

Address

WAGO Kontakttechnik GmbH & Co. KG

Hansastr. 27

32423 Minden

Telefon: 0571/887-0

Fax: 0571/887-169

<http://www.wago.com>

© WAGO Kontakttechnik GmbH & Co. KG

Technische Änderungen und Irrtümer vorbehalten.