

THIS DOCUMENT IS THE PROPERTY OF KEYSTONE ELECTRONICS CORP. AND SHALL NOT BE REPRODUCED, DISTRIBUTED OR USED AS A BASIS FOR MANUFACTURE WITHOUT PRIOR WRITTEN PERMISSION FROM KEYSTONE ELECTRONICS CORP.

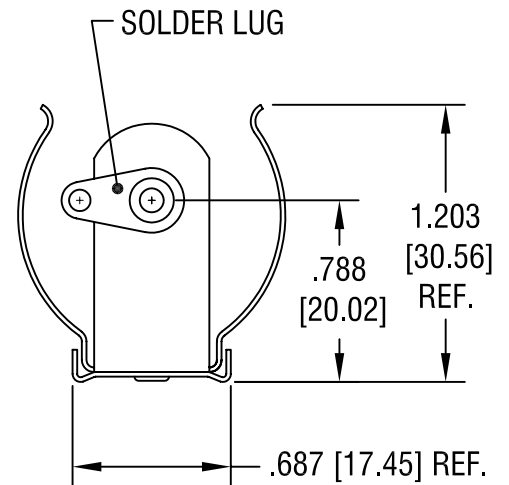
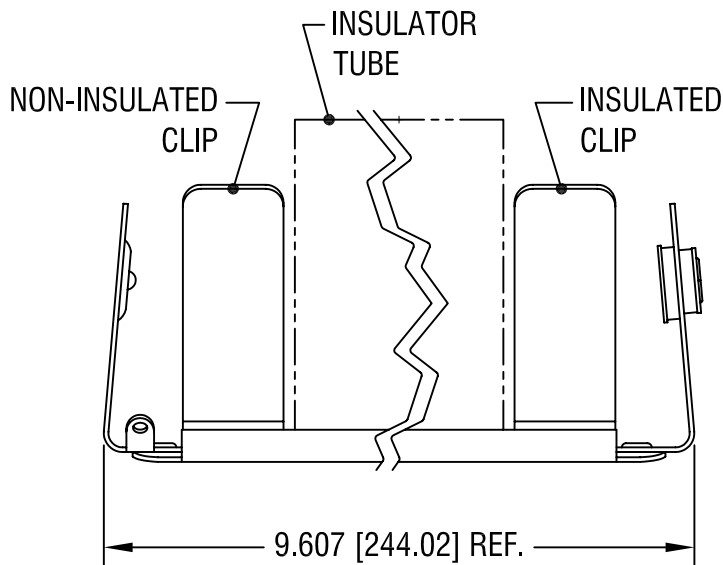
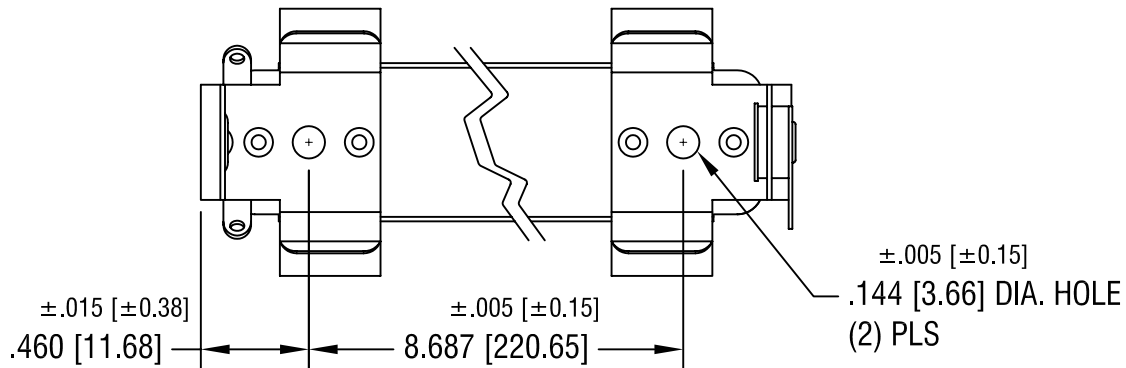

NOTES:

- 1. BASE: MAT'L - STAINLESS STEEL
- CLIP: MAT'L - SPRING STEEL
FINISH - NICKEL PLATE
- LUG: MAT'L - BRASS
FINISH - TIN PLATE
- TUBE: MAT'L - WOUND PAPER, BLACK

KEYSTONE ELECTRONICS CORP.

ASTORIA, N.Y. 11105-2017

PART NAME			
NON-INSULATED BATTERY HOLDER (4) 'D'			
MATERIAL			
AS NOTED			
FINISH		DRN BY	DATE
AS NOTED		BOONE	4.21.04
		APP'D	SCALE
			1.2X
TOLERANCES	INCH [MM]	CODE	DWG NO.
DECIMAL	$\pm .010$ [± 0.25]	C	1162
ANGULAR	$\pm 1^\circ$		
UNLESS OTHERWISE SPECIFIED			

DATE	DESCRIPTION	REV.