

Print Bohrplan Bestückungsseite
PCB-Layout (component side)

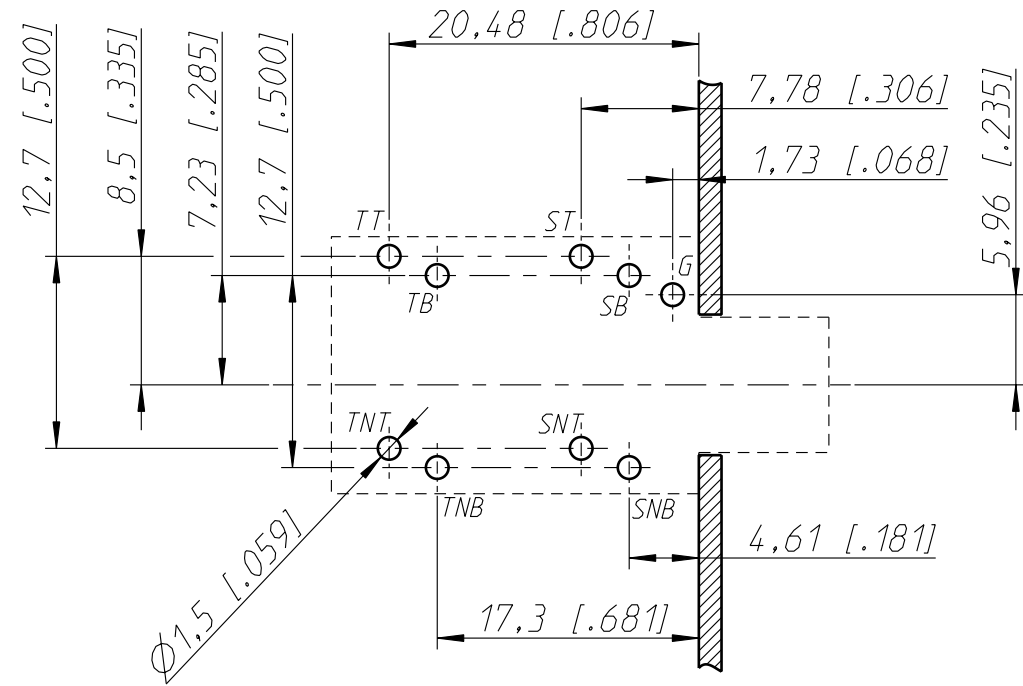

Frontplattenausschnitt (Rückseite)
Panel cut out (rear side)

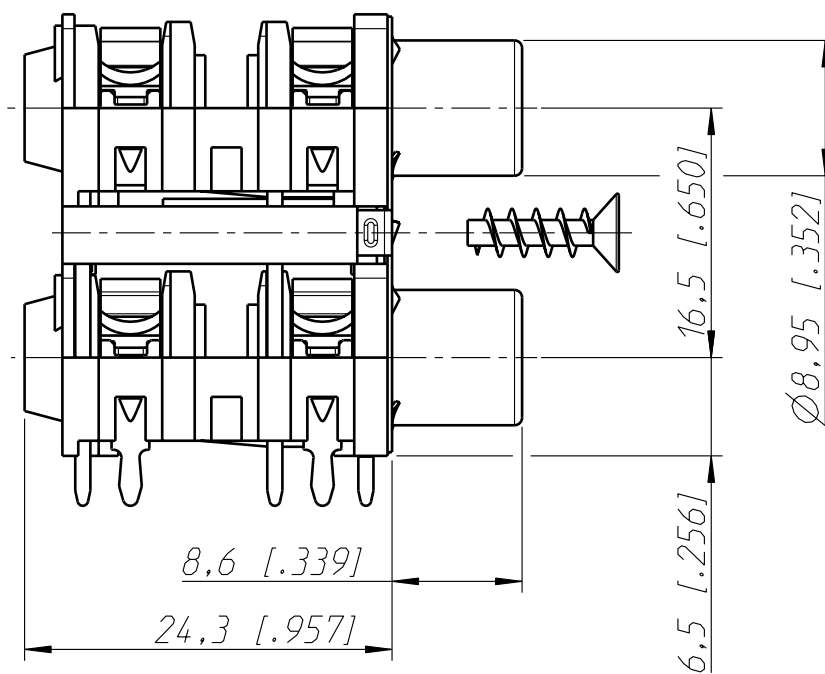
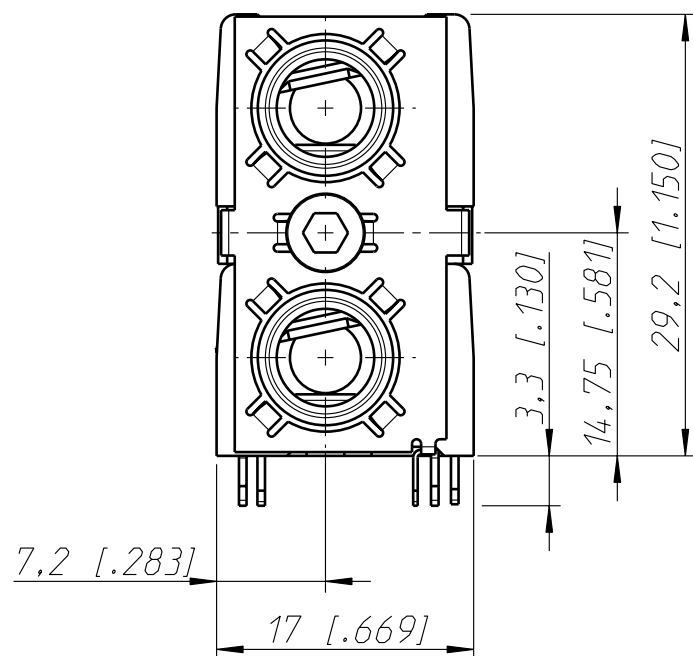
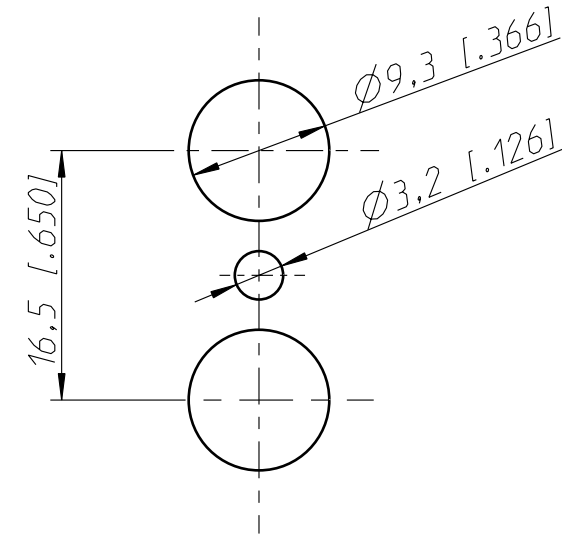

Allgemeintoleranzen ISO 2768-m	Werkstoff KEIN_MAT	Massstab: 2:1 (A3)	Gezeichnet	Datum	Name
			Freigegeben	31.01.03	Ender
Zeichnung urheberrechtlich geschützt (DIN 34) (C)	-	-	Geaendert	-	-
			Aend.-Nr.	-	Aend.-Index -
Benennung Stacking Jack NSJ8HC			Ersatz fuer:	Blatt 1 von 1 Bl.	
NEUTRIK AG FL-9494 SCHAAN			Zeichn. Nr. ST-NSJ8HC		