

THIS DOCUMENT IS THE PROPERTY OF
KEYSTONE ELECTRONICS CORP. AND
SHALL NOT BE REPRODUCED, DISTRIBUTED
OR USED AS A BASIS FOR MANUFACTURE
WITHOUT PRIOR WRITTEN PERMISSION
FROM KEYSTONE ELECTRONICS CORP.

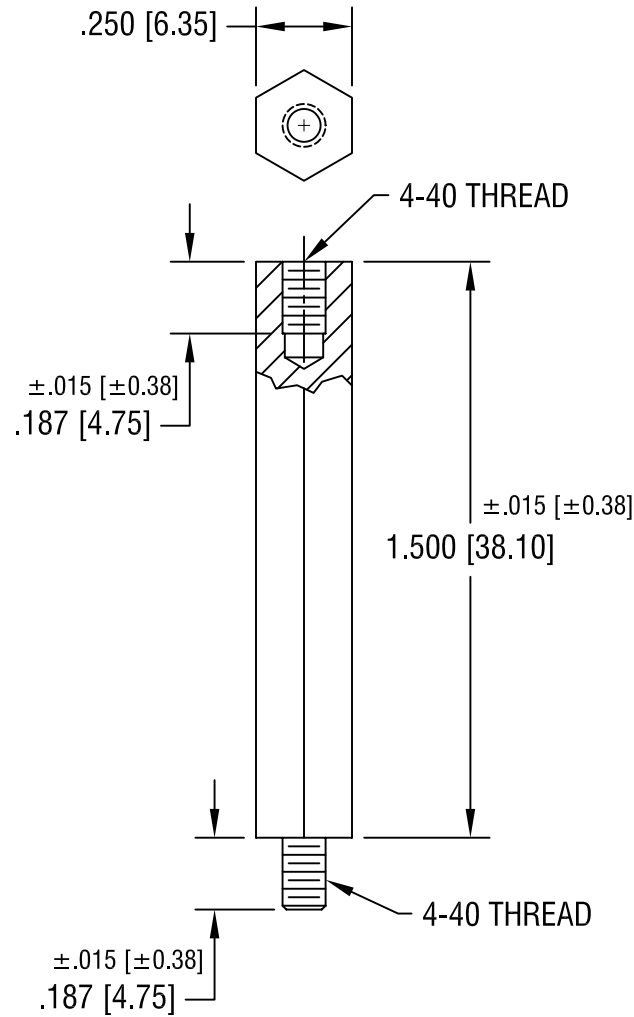

KEYSTONE ELECTRONICS CORP.

ASTORIA, N.Y. 11105-2017

PART NAME

NYLON M/F HEX STANDOFF

MATERIAL

NYLON 6/6

FINISH

-

DRN BY

BOONE

DATE

10.4.94

APP'D

SCALE

2X

TOLERANCES

INCH [MM]

CODE

DWG NO.

DECIMAL ±.005 [± 0.15]

C/M

4810

ANGULAR ± 1°
UNLESS OTHERWISE SPECIFIED

DATE	DESCRIPTION	REV.