

THIS DOCUMENT IS THE PROPERTY OF
KEYSTONE ELECTRONICS CORP. AND
SHALL NOT BE REPRODUCED, DISTRIBUTED
OR USED AS A BASIS FOR MANUFACTURE
WITHOUT PRIOR WRITTEN PERMISSION
FROM KEYSTONE ELECTRONICS CORP.

ACTUAL SIZE

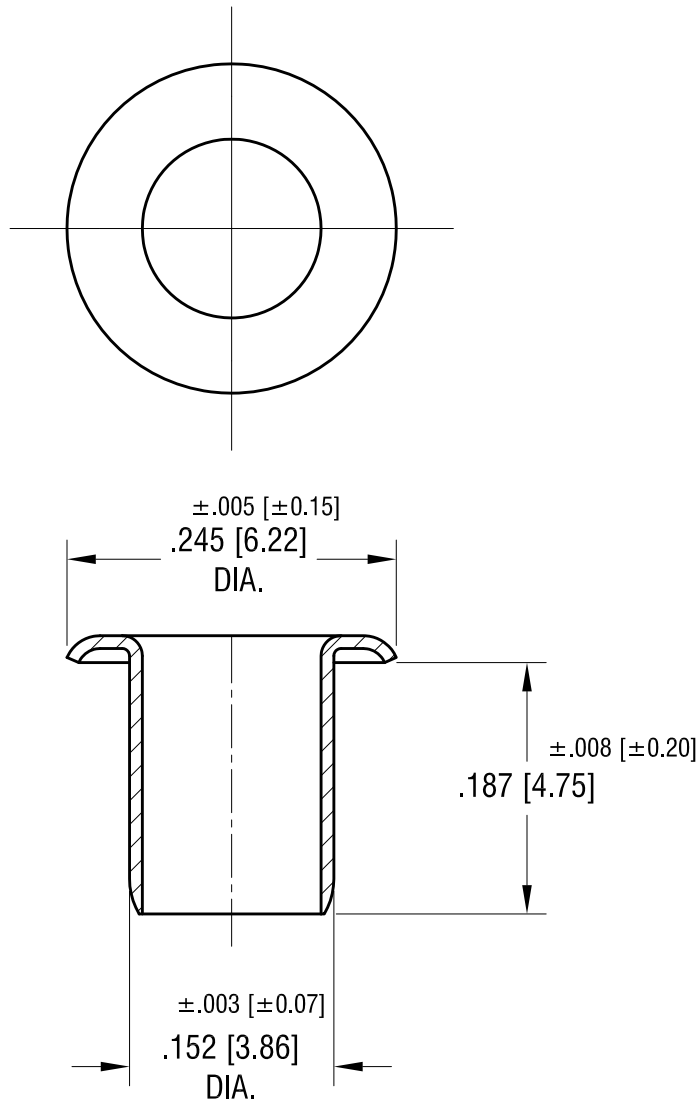

KEYSTONE ELECTRONICS CORP.

www.keyelco.com • ASTORIA, N.Y. 11105-2017 • Tel (718) 956-8900

PART NAME		WIDE ROLL EYELET	
MATERIAL		.010 [0.25] TH'K BRASS	
FINISH		DRN BY	DATE
TIN PLATE		NT	1.17.13
		APP'D	SCALE
		LN	7X
TOLERANCES	INCH [MM]	CODE	DWG NO.
DECIMAL	$\pm .005$ [± 0.13]	C	16
ANGULAR	$\pm 1^\circ$		
UNLESS OTHERWISE SPECIFIED			

DATE	DESCRIPTION	REV.