

FR 4x6 X - 4 Ohm

Art. No. 2254



9 x 15 cm (4" x 6") Breitbandlautsprecher mit Hochtonkegel. Breitbandiger und ausgewogener Frequenzgang. Gut geeignet für Musik und Sprachwiedergabe.

9 x 15 cm (4" x 6") full-range driver with tweeter cone. Wide and balanced frequency response. Well suited for speech and music.

Anwendungsmöglichkeiten / Typical applications

- Fahrzeuge, Reisemobile, ELA-Zeilen

- Vehicles, mobile homes, network column speakers

20.11.2013

FR 4x6 X - 4 Ohm

Art. No. 2254

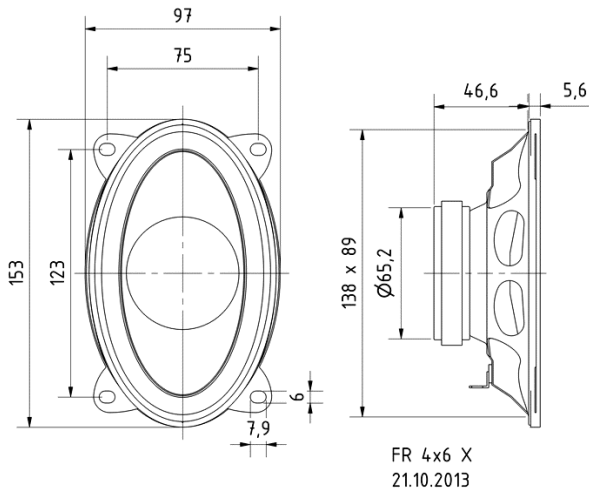

Technische Daten / Technical data

Nennbelastbarkeit Rated power	15 W
Musikbelastbarkeit Maximum power	30 W
Nennimpedanz Z Nominal impedance Z	4 Ohm
Übertragungsbereich Frequency response	75–20000 Hz
Mittlerer Schalldruckpegel Mean sound pressure level	87 dB (1 W/1 m)
Resonanzfrequenz f_s Resonance frequency f_s	110 Hz
Obere Polplattenhöhe Height of front pole-plate	3,5 mm
Schwingspulendurchmesser Voice coil diameter	25 mm
Schallwandöffnung Cutout diameter	142 x 90 mm
Gewicht netto Net weight	0,456 kg
Anschlüsse Connections	4,8 x 0,8 mm (+) 2,8 x 0,8 mm (-)

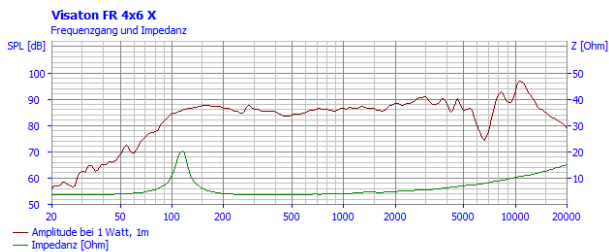

20.11.2013