

All rights reserved, Copyright Kradex 2016		
Product model	Enclosure Z67 - assembly	
Format: A3	Material: PS, ABS	
Scale 1:1	Tolerance: +/- 0.5	

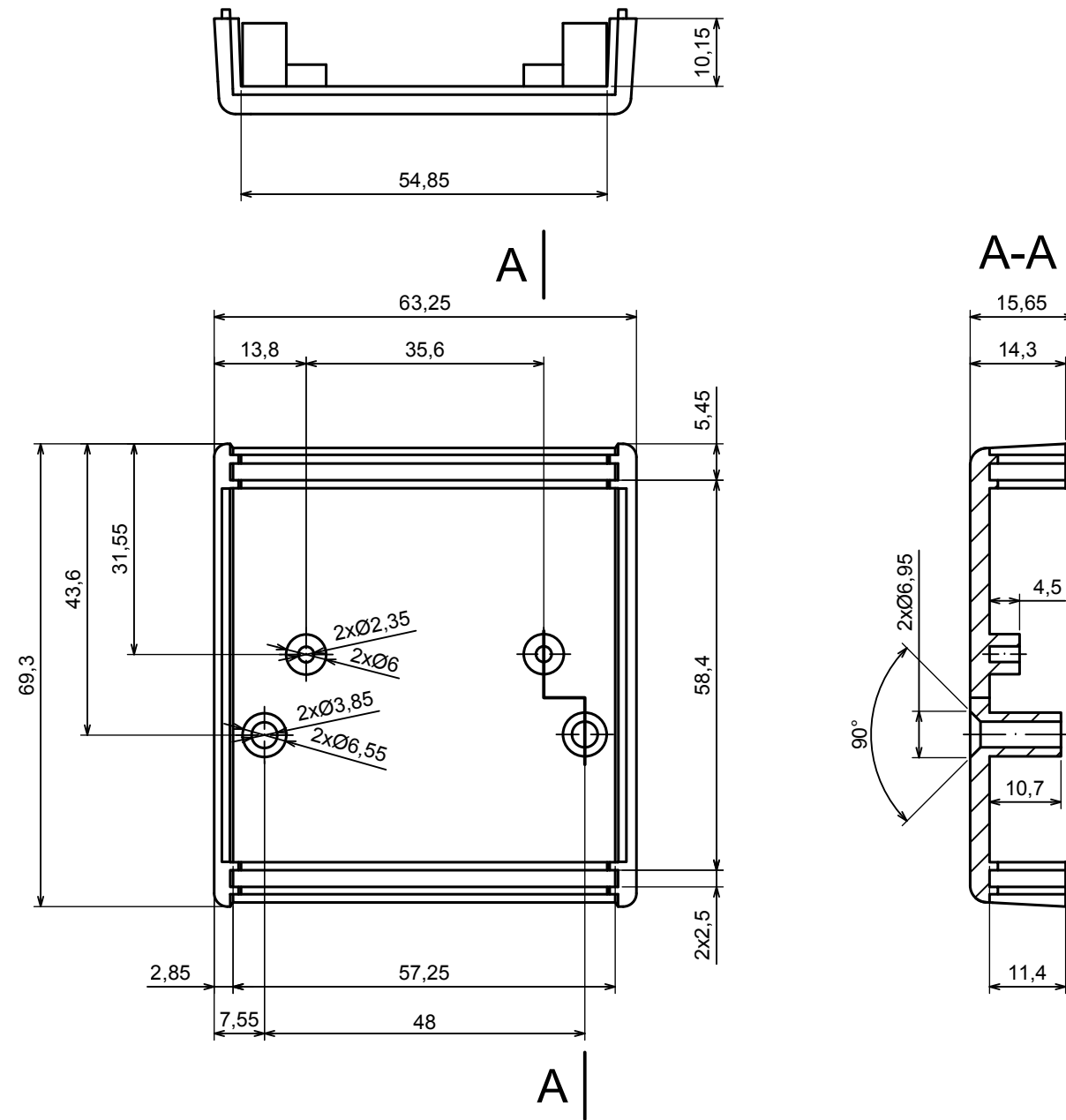

All rights reserved, Copyright Kradox 2016

Product model Enclosure Z67 - base

Format: A3 Material: PS, ABS

Scale 1:1 Tolerance: +/- 0.5



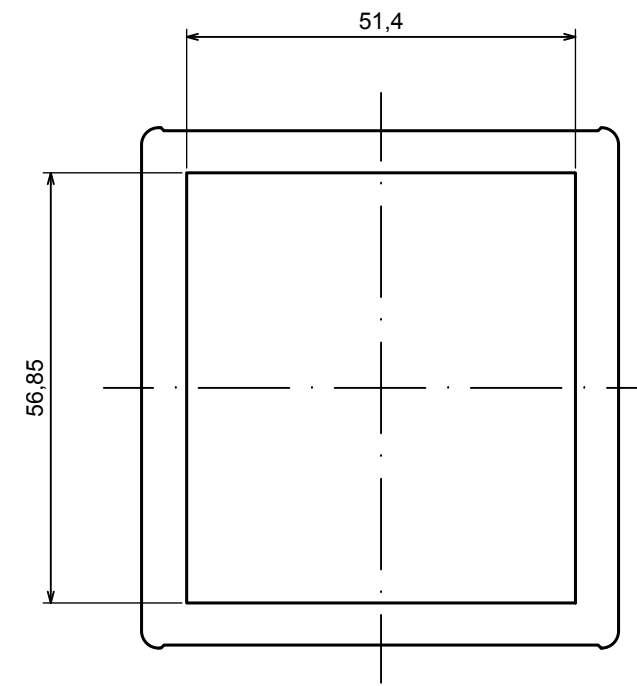
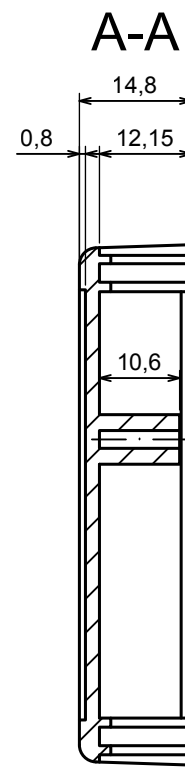
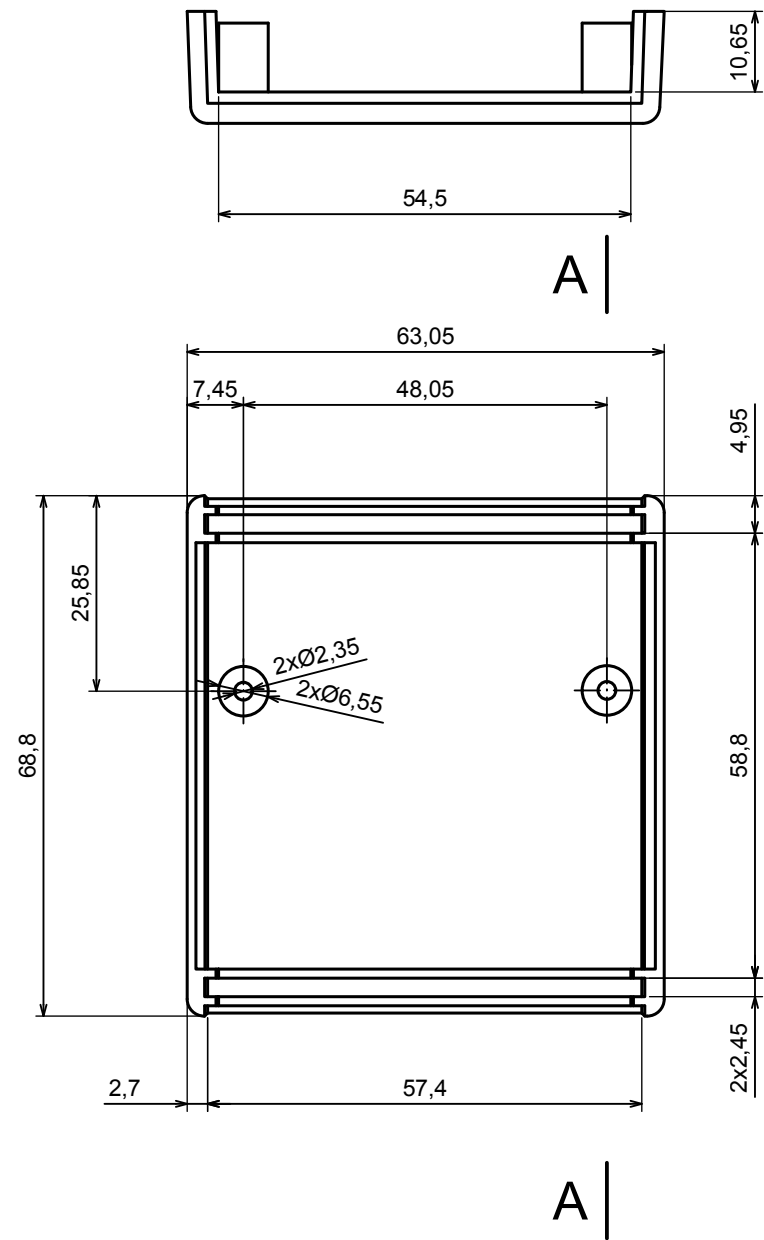

All rights reserved, Copyright Kradex 2016

Product model Enclosure Z67 - cover

Format: A3 Material: PS, ABS

Scale 1:1 Tolerance: +/- 0.5



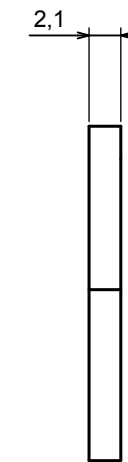
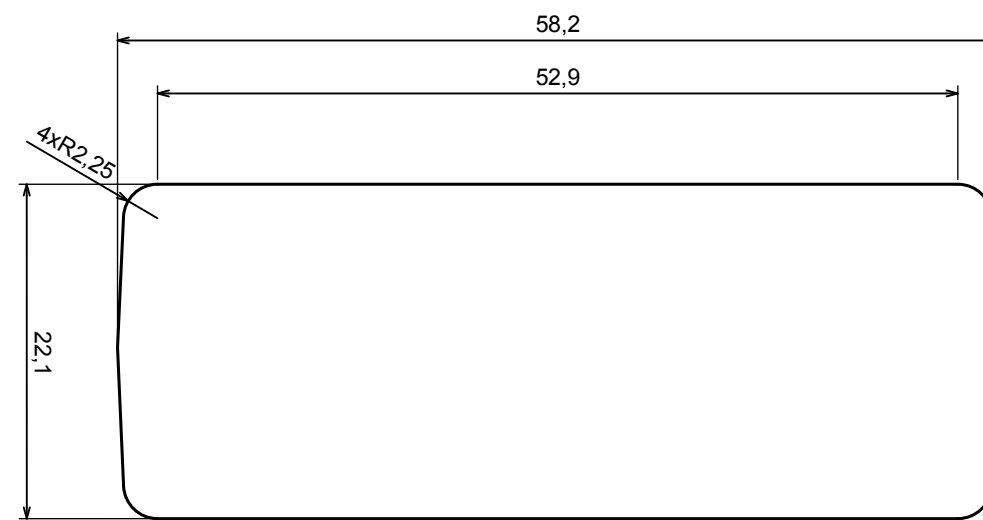

All rights reserved, Copyright Kradex 2016		
Product model	Enclosure Z67 - board	
Format: A3	Material: PS, ABS	
Scale 1:1	Tolerance: +/- 0.5	