

THIS DOCUMENT IS THE PROPERTY OF
KEYSTONE ELECTRONICS CORP. AND
SHALL NOT BE REPRODUCED, DISTRIBUTED
OR USED AS A BASIS FOR MANUFACTURE
WITHOUT PRIOR WRITTEN PERMISSION
FROM KEYSTONE ELECTRONICS CORP.

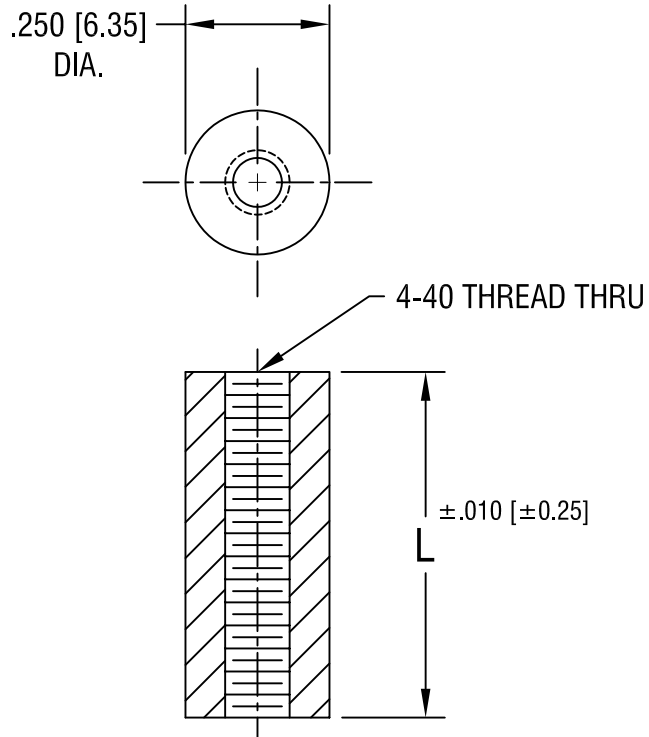

PART NO.	'L' DIM.
376	.250 [6.35]
377	.375 [9.52]
378	.500 [12.70]
379	.750 [19.05]
380	1.000 [25.4]

KEYSTONE ELECTRONICS CORP.

ASTORIA, N.Y. 11105-2017

PART NAME

THREADED ROUND STANDOFF

MATERIAL

PHENOLIC

FINISH

-

DRN BY

BOONE

DATE

9.13.99

APPD

SCALE

3X

TOLERANCES

INCH [MM]

DECIMAL ± .005 [± 0.15]

ANGULAR ± 1°
UNLESS OTHERWISE SPECIFIED

CODE

C/M

DWG NO.

376-380

DATE

DESCRIPTION

REV.