

THIS DOCUMENT IS THE PROPERTY OF  
KEYSTONE ELECTRONICS CORP. AND  
SHALL NOT BE REPRODUCED, DISTRIBUTED  
OR USED AS A BASIS FOR MANUFACTURE  
WITHOUT PRIOR WRITTEN PERMISSION  
FROM KEYSTONE ELECTRONICS CORP.

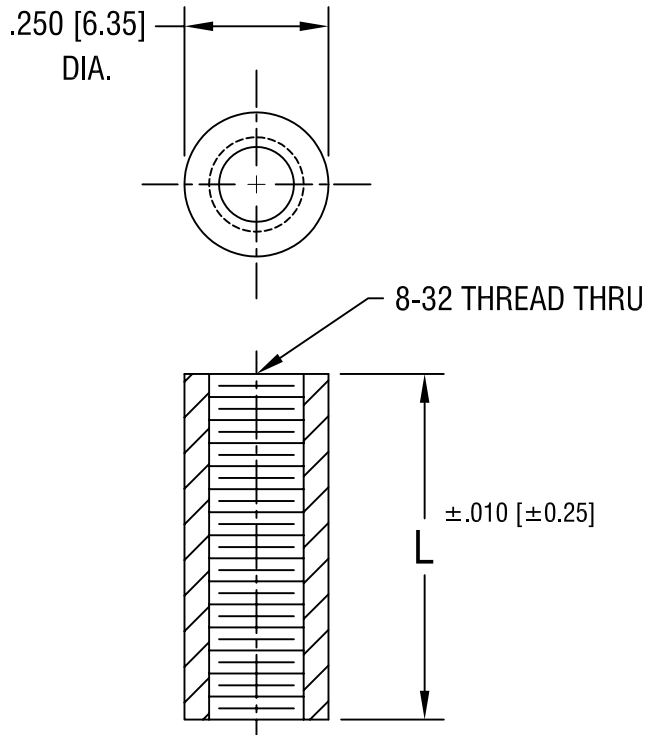

PART NO.	'L' DIM.
390	.250 [6.35]
391	.375 [9.52]
392	.500 [12.70]
393	.750 [19.05]
394	1.000 [25.4]

<b>KEYSTONE ELECTRONICS CORP.</b>			
ASTORIA, N.Y. 11105-2017			
PART NAME THREADED ROUND STANDOFF			
MATERIAL PHENOLIC			
FINISH -		DRN BY BOONE	DATE 9.13.99
		APPD	SCALE 3X
TOLERANCES	INCH [MM]	CODE	DWG NO.
DECIMAL	± .005 [± 0.15]	C/M	<b>390-394</b>
ANGULAR	± 1°		
UNLESS OTHERWISE SPECIFIED			

DATE	DESCRIPTION	REV.