

**ebm-papst St. Georgen GmbH & Co. KG**

Hermann-Papst-Str. 1

D-78112 St. Georgen

Phone +49 (0) 7724 81-0

Fax +49 (0) 7724 81-1309

info2@de.ebmpapst.com

www.ebmpapst.com

Nominal data

Type	3656	
Phase		1~
Nominal voltage	VAC	230
Frequency	Hz	50
Speed	min ⁻¹	2700
Power input	W	12.0
Min. ambient temperature	°C	-40
Max. ambient temperature	°C	75
Air flow	m ³ /h	75
Sound power level	B	4.9
Sound pressure level	dB(A)	37

ml = Max. load · me = Max. efficiency · fa = Running at free air · cs = Customer specs · cu = Customer unit
Subject to alterations



Technical features

Mass	0.420 kg
Dimensions	92 x 92 x 38 mm
Material of impeller	Sheet steel, coated in black
Housing material	Die-cast aluminium
Direction of air flow	Exhaust over struts
Direction of rotation	Right, looking at rotor
Bearing	Ball bearings
Lifetime L10 at 40 °C	52500 h
Lifetime L10 at maximum temperature	22500 h
Connection line	With 2 single strands AWG 18 Grounding lug M4 x 8
Motor protection	Protected from overload using impedance protection
Approval	VDE, CSA, UL, CE

Product drawing

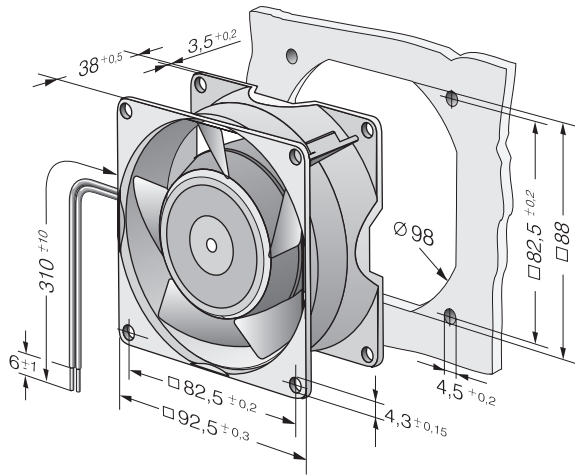

Charts: Air flow

