

THIS DOCUMENT IS THE PROPERTY OF KEYSTONE ELECTRONICS CORP. AND SHALL NOT BE REPRODUCED, DISTRIBUTED OR USED AS A BASIS FOR MANUFACTURE WITHOUT PRIOR WRITTEN PERMISSION FROM KEYSTONE ELECTRONICS CORP.

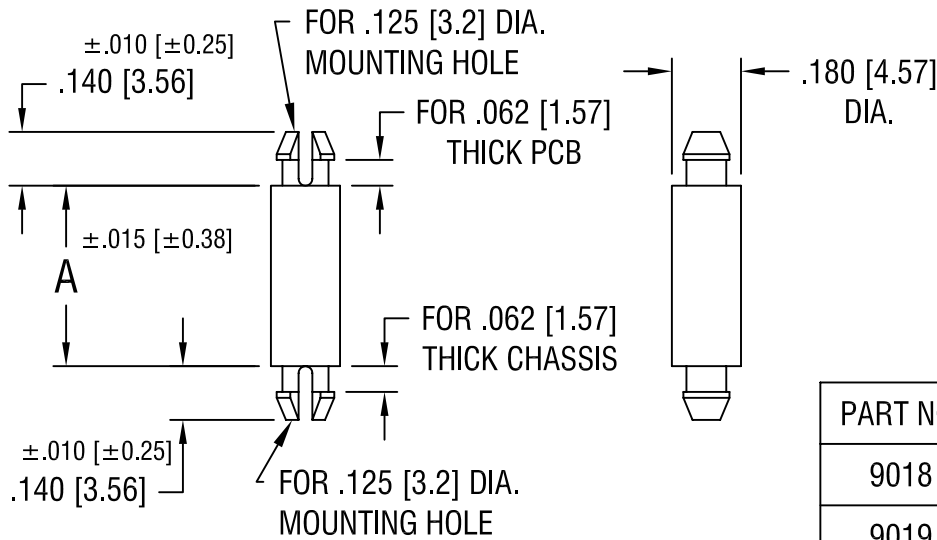

PART NO.	'A' DIM.
9018	.125 [3.18]
9019	.187 [4.75]
9020	.250 [6.35]
9021	.375 [9.52]
9022	.500 [12.70]
9023	.625 [15.87]
9024	.750 [19.05]
9025	.875 [22.22]
9026	1.000 [25.40]

**KEYSTONE ELECTRONICS CORP.**

ASTORIA, N.Y. 11105-2017

PART NAME		PC LOCK-IN SUPPORT	
MATERIAL		NYLON UL 94V-0	
FINISH	-	DRN BY	BOONE
		APP'D	LN
		DATE	8.29.06
		SCALE	2X
TOLERANCES	INCH [MM]	CODE	DWG NO.
DECIMAL	$\pm .005$ [ $\pm 0.15$ ]	C/M	9018-9026
ANGULAR	$\pm 1^\circ$		
UNLESS OTHERWISE SPECIFIED			

DATE	DESCRIPTION	REV.