

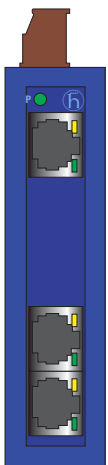

## Description and operating instructions Industrial ETHERNET Rail Switch

## SPIDER xTX(/xFX)



SPIDER 3TX-TAP

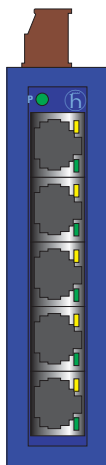

SPIDER 5TX  
SPIDER 5TX EEC

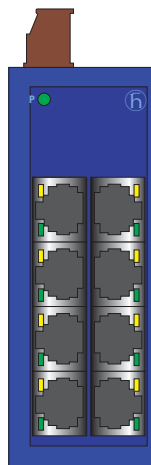

SPIDER 8TX  
SPIDER 8TX EEC

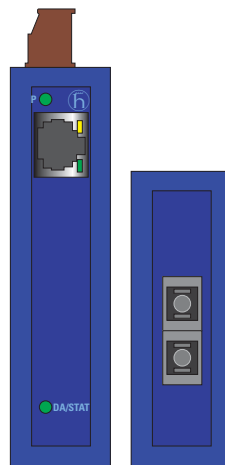

SPIDER 1TX/1FX  
SPIDER 1TX/1FX EEC  
SPIDER 1TX/1FX-SM  
SPIDER 1TX/1FX-SM EEC

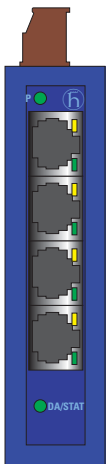

SPIDER 4TX/1FX  
SPIDER 4TX/1FX EEC  
SPIDER 4TX/1FX-SM EEC

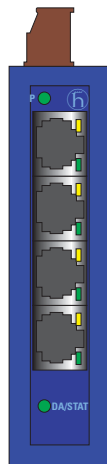

SPIDER 4TX/1FX-ST EEC

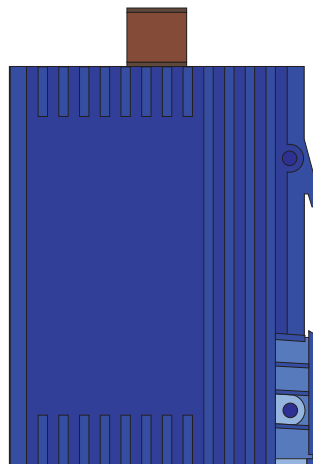

SPIDER

The Rail Switches / media converters

- SPIDER 3TX-TAP
- SPIDER 5TX
- SPIDER 5TX EEC
- SPIDER 8TX
- SPIDER 8TX EEC
- SPIDER 1TX/1FX (media converter)
- SPIDER 1TX/1FX EEC (media converter)
- SPIDER 1TX/1FX-SM (media converter)
- SPIDER 1TX/1FX-SM EEC (media converter)
- SPIDER 4TX/1FX
- SPIDER 4TX/1FX EEC
- SPIDER 4TX/1FX-ST EEC
- SPIDER 4TX/1FX-SM EEC

in short SPIDER, are switches especially designed for use in industrial environments. It supports ETHERNET 10 MBit/s and Fast ETHERNET 100 MBit/s.

The devices support switched ETHERNET networks in accordance with IEEE standard 802.3 or 802.3u using copper and fiber optic technology. The devices are plugged onto the standard bar.

The SPIDER 3TX-TAP (SPIDER 5TX, SPIDER 5TX EEC, SPIDER 8TX, SPIDER 8TX EEC) devices have three (five, eight) 10/100 MBit/s twisted pair ports (RJ45 connectors). It is possible to connect up to three (five, eight) data terminal equipments or other network segments to the TP ports using twisted pair cabling.

The SPIDER 1TX/1FX... devices have one 10/100 MBit/s twisted pair port (RJ45 connectors) and one 100 MBit/s fiber optic port (100BASE-FX, Duplex SC connector). It is possible to connect one data terminal equipments or other network segments to the TP ports using twisted pair cabling. One further DTE or optical network component can be connected to the fiber port.

The SPIDER 4TX/1FX... devices have four 10/100 MBit/s twisted pair ports (RJ45 connectors) and one 100 MBit/s fiber optic port (100BASE-FX, Duplex SC connector or ST connector on SPIDER 4TX/1FX-ST EEC). It is possible to connect up to four data terminal equipments or other network segments to the TP ports using twisted pair cabling. One further DTE or optical network component can be connected to the fiber port.

The TP ports support autonegotiation, auto-polarity and autocrossing.

The fiber optic port of the SPIDER 1TX/1FX... and SPIDER 4TX/1FX... supports full duplex (FDX).



039669004030706000

The performance features described here are binding only if they have been expressly guaranteed in the contract. We have checked that the contents of the technical publication agree with the hardware and software described. However, it is not possible to rule out deviations completely, so we are unable to guarantee complete agreement. However, the details in the technical publication are checked regularly. Any corrections which prove necessary are contained in subsequent editions. We are grateful for suggestions for improvement.

We reserve the right to make technical modifications.

Permission is not given for the circulation or reproduction of this document, its use or the passing on of its contents unless granted expressly. Contravention renders the perpetrator liable for compensation for damages. All rights reserved, in particular in the case of patent grant or registration of a utility or design.

Copyright  
© Hirschmann  
Automation and Control GmbH 2006  
All Rights Reserved

## Note

We would point out that the content of these operating instructions is not part of, nor is it intended to amend an earlier or existing agreement, permit or legal relationship. All obligations on Hirschmann arise from the respective purchasing agreement which also contains the full warranty conditions which have sole applicability. These contractual warranty conditions are neither extended nor restricted by comments in these operating instructions.

We would furthermore point out that for reasons of simplicity, these operating instructions cannot describe every conceivable problem associated with the use of this equipment. Should you require further information or should particular problems occur which are not treated in sufficient detail in the operating instructions, you can request the necessary information from your local Hirschmann sales partner or directly from the Hirschmann office (address: refer to chapter entitled „Notes on CE identification“).

## Safety Instructions

This manual contains instructions which must be observed to ensure your own personal safety and to avoid damage to devices and machinery. The instructions are highlighted with a warning triangle and are shown as follows according to the degree of endangerment:



### Danger!

means that death, serious injury or considerable damage to property **will** result if the appropriate safety measures are not taken.



### Warning!

means that death, serious injury or considerable damage to property **can** result if the appropriate safety measures are not taken.



### Caution!

means that light injury or damage to property can result if the appropriate safety measures are not taken.

**Note:** is an important piece of information about the product, how to use the product, or the relevant section of the documentation to which particular attention is to be drawn.

## Certified usage

Please observe the following:



### Warning

The device may only be employed for the purposes described in the catalog and technical description, and only in conjunction with external devices and components recommended or approved by Hirschmann. The product can only be operated correctly and safely if it is transported, stored, installed and assembled properly and correctly. Furthermore, it must be operated and serviced carefully.

## Safety Guidelines Power Supply

Switch the basic devices on only when the case is closed.



### Warning!

The devices may only be connected to the supply voltage shown on the type plate.

The devices are designed for operation with a safety extra-low voltage. Thus, they may only be connected to the supply voltage connections with PELV circuits or alternatively SELV circuits with the voltage restrictions in accordance with IEC/EN 60950-1.

For the case where the module is operated with external power supply: Use only a safety extra-low voltage in accordance with IEC/EN 60950-1 to power the system.

First of all you connect the ground connection, before you establish the further connections. When you remove connections, you disconnect the ground connection last.

Relevant for North America: The subject unit is to be supplied by a Class 2 power source complying with the requirements of the National Electrical Code, table 11(b).

Relevant for North America: Power, input and output (I/O) wiring must be in accordance with Class I, Division 2 wiring methods [Article 501-4(b) of the National Electrical Code, NFPA 70] and in accordance with the authority having jurisdiction.

Peripheral equipment must be suitable for the location it is used in.

Use 60/75°C or 75°C copper(CU)wire only.

## Safety Guidelines Shielding Ground

Beware of possible short circuits when connecting a cable section with conductive shielding braiding.

## Safety Guidelines Housing



### Warning!

Only technicians authorized by Hirschmann are permitted to open the housing.

**Note:** The SPIDER is grounded via a pin of the 3pin terminal block.

Make sure that the electrical installation meets local or nationally applicable safety regulations.



### Warning!

The ventilation slits must not be covered so as to ensure free air circulation.

The distance to the ventilation slots on the top and the bottom of the housing has to be a minimum of 10 cm.

The side distance of the SPIDER 4TX/1FX... and SPIDER 8TX... devices to neighbour devices has to be a minimum of 2 cm if the ambient temperature is higher than 50°C.

Never insert pointed objects (thin screwdrivers, wires, etc.) into the inside of the subrack! Failure to observe this point may result in injuries caused by electric shocks.

**Note:** If installed in a living area or office environment, the device must be operated exclusively in switch cabinets with fire protection characteristics according to EN 60950-1.

**Note:** The housing has to be mounted in upright position.

## Safety Guidelines Environment



### Warning!

The device may only be operated in the listed ambient temperature range at the listed relative air humidity (non-condensing).

The installation location is to be selected so as to ensure compliance with the climatic limits listed in the Technical Data.

To be used in an up to Pollution Degree 2 environment only (IEC 60664-1).

## Staff qualification requirements

**Note:** Qualified personnel, as understood in this manual and in the warning signs, are persons who are familiar with the setup, assembly, startup, and operation of this product and are appropriately qualified for their job. This includes, for example, those persons who have been:

- trained or directed or authorized to switch on and off, to ground and to label power circuits and devices or systems in accordance with current safety engineering standards
- trained or directed in the care and use of appropriate safety equipment in accordance with the current standards of safety engineering
- trained in providing first aid.

## General Safety Instructions

This device is electrically operated. Adhere strictly to the safety requirements relating to voltages applied to the device as described in the operating instructions!



### Warning!

Failure to observe the information given in the warnings could result in serious injury and/or major damage.

Only personnel that have received appropriate training should operate this device or work in its immediate vicinity. The personnel must be fully familiar with all of the warnings and maintenance measures in these operating instructions.

Correct transport, storage, and assembly as well as careful operation and maintenance are essential in ensuring safe and reliable operation of this device.

Use only undamaged parts!

- These products are only to be used in the manner indicated in this version of the "Description and Operating Instructions".
- Particular attention is to be paid to all warnings and items of information relating to safety.



### Warning!

Any work that may have to be performed on the electrical installation should be performed by fully qualified technicians only.



### Warning!

(SPIDER 1TX/1FX...  
SPIDER 4TX/1FX...)  
LED- or LASER components according to IEC 60825-1 (2001):  
CLASS 1 LASER PRODUCT.  
LIGHT EMITTING DIODE - CLASS 1  
LED PRODUCT.

## Based specifications and standards:

The devices fulfil the following specifications and standards:

- EN 61000-6-2:2001 Generic standards – Immunity for industrial environments
- EN 55022:1998 + A1:2000 + A2:2003 – Information technology equipment – Radio disturbance characteristics
- EN 60950-1:2001 – Safety of Information Technology Equipment (ITE)
- EN 61131-2:2003 – Programmable Controllers
- FCC 47 CFR Part 15:2004 – Code of Federal Regulations
- cUL 508:1998 – Underwriters Laboratories Inc. Safety for Industrial Control Equipment.

Certified devices are marked with a certification identifier.

## CE identification

The devices comply with the regulations of the following European directive:

89/336/EEC

Council Directive on the harmonization of the legal regulations of member states on electromagnetic compatibility (amended by Directives 91/263/EEC, 92/31/EEC and 93/68/EEC).

SPIDER 5TX EEC:

72/245/EEC, 2005/83/EG

Radio interference (electromagnetic compatibility) in vehicles  
Certified devices are marked with a e1 certification identifier.

The EU declaration of conformity is kept available for the responsible authorities in accordance with the above-mentioned EU directives at:

Hirschmann  
Automation and Control GmbH  
Stuttgarter Straße 45-51  
D-72654 Neckartenzlingen  
Telefon ++49-(0)1805-14-1538

The product can be used in the residential sphere (residential sphere, business and trade sphere and small companies) and in the industrial sphere.

- Interference immunity:  
EN 61000-6-2:2001
- Radio interference level:  
EN 55022:1998 + A1:2000  
+ A2:2003, Class A



### Warning!

This is a Class A device. This equipment may cause radio interference if

used in a residential area; in this case it is the operator's responsibility to take appropriate measures.

The precondition for compliance with EMC limit values is strict adherence to the construction guidelines specified in this description and operating instructions.

## FCC Note:

This equipment has been tested and found to comply with the limits for a Class A digital device, pursuant to part 15 of the FCC Rules. These limits are designed to provide reasonable protection against harmful interference when the equipment is operated in a commercial environment. This equipment generates, uses, and can radiate radio frequency energy and, if not installed and used in accordance with the instruction manual, may cause harmful interference to radio communications. Operation of this equipment in a residential area is likely to cause harmful interference in which case the user will be required to correct the interference at his own expense.



## Recycling Note:

After its use, this product has to be processed as electronic scrap and disposed of according to the prevailing waste disposal regulations of your community / district / country / state.

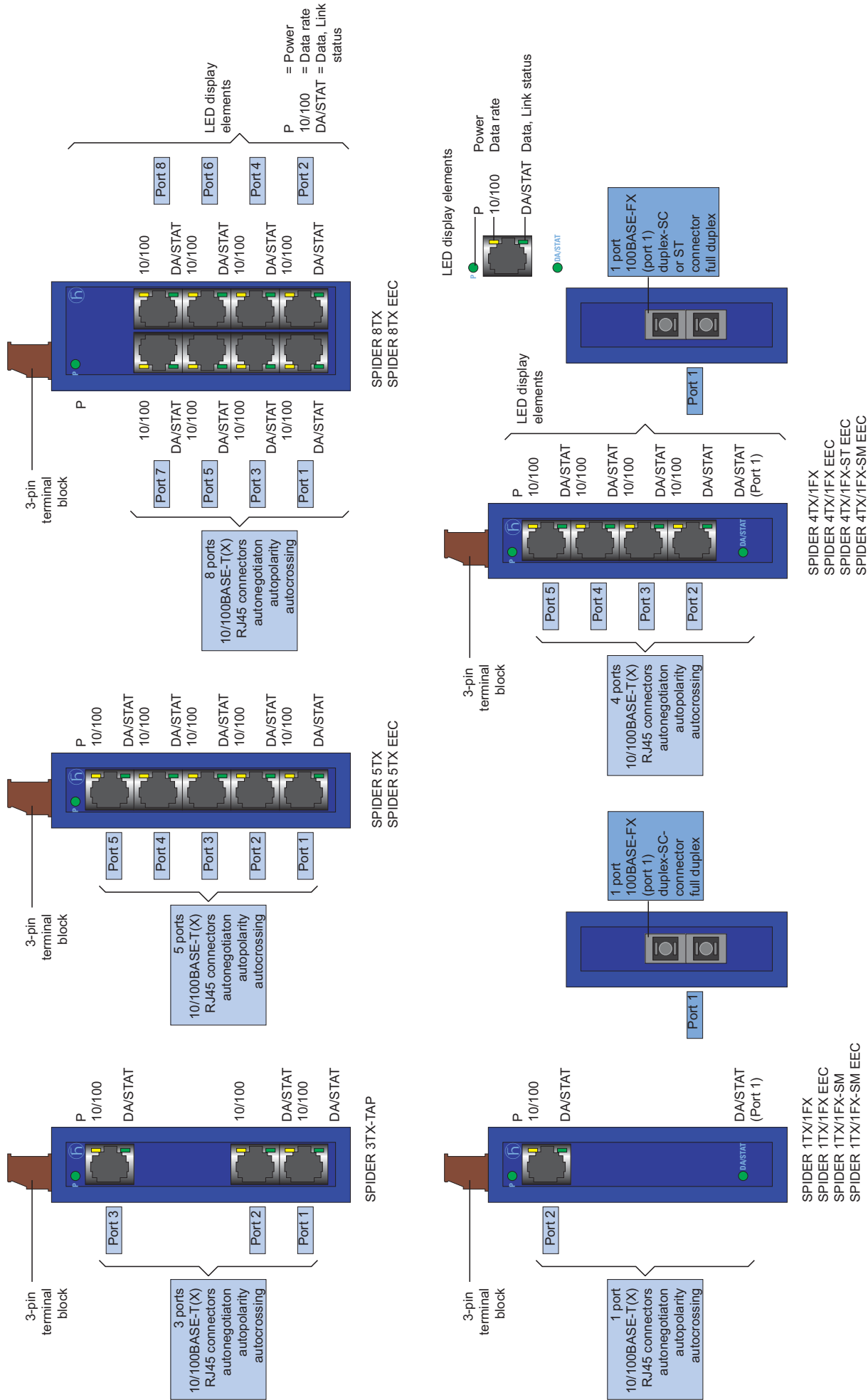

Fig. 1: Overview interfaces, display elements and controls of the SPIDER xTX(/xFX)

## 1. Functional description

The 10/100BASE-T(X) ports of an SPIDER represent a terminal connection for the connected LAN segment. You can connect single devices or complete network segments.

### 1.1 FRAME SWITCHING FUNCTIONS Store and Forward

All data received by the SPIDER from the system bus or at the ports are stored and checked for validity. Invalid and defective frames (> 1.522 byte or CRC error) as well as fragments (< 64 byte) are discarded. The SPIDER forwards the valid frames.

#### Multi address capability

A SPIDER learns all source addresses per port. Only packets with

- unknown addresses
  - addresses learnt at this port
  - a multi/broadcast address
- in the destination address field are sent to this port.

A SPIDER learns up to 1,000 addresses. This becomes necessary if more than one terminal device is connected to one or more ports. In this way several independent sub-networks can be connected to an SPIDER.

#### Learnt addresses

An SPIDER monitors the age of the learned addresses. The SPIDER deletes address entries from the address table which exceed a certain age (300 seconds).

**Note:** Restarting deletes the learned address entries.

#### Tagging (IEEE 802.1Q)

The IEEE 802.1 Q standard designates the VLAN tag to be included in a MAC data frame for the VLAN and prioritizing functions. The VLAN tag consists of 4 bytes (2 bytes tag protocol identifier TPID, 2 bytes tag control information TCI). It is inserted between the source address field and the type field. Data packets with VLAN tag are transmitted unchanged by the SPIDER.

### 1.2 SPECIFIC FUNCTIONS OF THE TP/TX INTERFACE

#### Link control

The SPIDER monitors the connected TP line segments for short-circuit or interrupt using regular link test pulses in accordance with IEEE standard 802.3 10BASE-T/100BASE-TX. The SPIDER does not transmit any data to a TP segment from which it does not receive a link test pulse.

**Note:** A non-occupied interface is assessed as a line interrupt. The TP line to terminal equipment which is switched off is likewise assessed as a line interrupt as the de-energised bus coupler cannot transmit link test pulses.

#### Auto polarity exchange

If the receive line pair is incorrectly connected (RD+ and RD- switched) polarity is automatically reversed.

### Autonegotiation

Autonegotiation is a procedure in which the switch automatically selects the operating mode of its 10/100 RJ-45 ports. When a connection is set up for the first time, the switch detects the speed (10 or 100 Mbit/s) and the transmission mode of the connected network (half duplex or full duplex).

### Autocrossing

The SPIDER detects the transmit and receive pairs (MDI, MDI-X). The SPIDER automatically configures its port for the correct transmit and receive pins. Consequently it does not matter whether you connect devices using a cross-over or straight cable.

### 1.3 SPECIFIC FUNCTIONS OF THE F/O INTERFACE

#### Link control

The device

- SPIDER 1TX/1FX...
  - SPIDER 4TX/1FX...
- monitors the connected F/O line for interrupts in accordance with IEEE standard 802.3 100BASE-FX.

#### Low Light Detection

If the optical input power decreases below the low light threshold the transmit and receive path will be disabled for data and the idle signal will be transmitted.

#### Far-End Fault

The optical transmission distance of the

- SPIDER 1TX/1FX...
- SPIDER 4TX/1FX...

can be monitored in receiving direction as well as in transmitting direction, if the other side also supports Far-End Fault. If the other side does not support Far-End Fault, the optical transmission distance is monitored only in receiving direction. Far-End Fault is sent, if the optical input power at the optical port has fallen under the low light level. If Far-End Fault is received, the link stays inactive (DA/STAT LED dark).

### 1.4 FURTHER FUNCTIONS AND FEATURES

#### Reset

The SPIDER will be reset by the following action:

- input voltages fall below a threshold

After a reset the following action is carried through:

- initialization

### 1.5 DISPLAY ELEMENTS Equipment status

These LEDs provide information about statuses which affect the function of the entire SPIDER.

**P – Power** (green LED)

- lit: – supply voltage present

#### Port Status

These LEDs display port-related information.

### DA/STAT – Data, Link status (green LED)

- not lit: – no valid link
- lit green: – valid link
- flashes green: – data traffic

### 10/100 – Data rate (yellow LED)

Twisted Pair Ports)

- leuchtet nicht: 10 Mbit/s link
- leuchtet yellow: 100 Mbit/s link

### 1.6 INTERFACES

#### 10/100 MBit/s connection

- One port (port 2, SPIDER 1TX/1FX...)
- Three ports (port 1 to 3, SPIDER 3TX-TAP)
- Four ports (port 2 to 5, SPIDER 4TX/1FX...)
- Five ports (port 1 bis 5, SPIDER 5TX, SPIDER 5TX EEC)
- Eight ports (port 1 to 8, SPIDER 8TX, SPIDER 8TX EEC)

(10/100 Mbit/s, 8-pin R45 sockets) allow terminal equipment or (depending on type) up to eight independent network segments complying with the standards IEEE 802.3 100BASE-TX / 10BASE-T to be connected. These ports support autonegotiation, auto-polarity and autocrossing.

– **Pin configuration** of the RJ45 socket:

- 1 line pair: pin 3 and pin 6
- 1 line pair: pin 1 and pin 2
- remaining pins: not used.

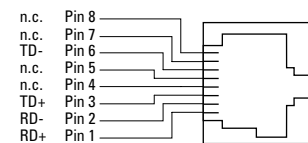

Fig. 2: Pin configuration of an TP interface

#### 100 Mbit/s connection (FX port)

The 100 MBit/s ports of the

- SPIDER 1TX/1FX...
  - SPIDER 4TX/1FX...
- supports the IEEE 802.3 100BASE-FX FDX standard.

The devices

- SPIDER 1TX/1FX
- SPIDER 1TX/1FX EEC
- SPIDER 1TX/1FX-SM
- SPIDER 1TX/1FX-SM EEC
- SPIDER 4TX/1FX
- SPIDER 4TX/1FX EEC
- SPIDER 4TX/1FX-SM EEC

use a duplex SC connector, the SPIDER 4TX/1FX-ST EEC uses a ST connector.

The 100 MBit/s port allows one further DTE or an optical network component to be connected.

#### 3pin terminal block

The supply voltage is connected via a 3pin terminal block.

#### Note:

Terminal tightening torque of line binding screws: 0.5 Nm



#### Warning!

The SPIDER devices are designed for operation with a safety extra-low voltage. Thus, they may only be connected to the supply voltage connections with PELV circuits or alternatively SELV circuits with the voltage restrictions in accordance with IEC/EN 60950-1.



– **Voltage supply:** The supply voltage is electrically isolated from the housing.

– **Ground connection:** The SPIDER is grounded via a pin of the 3pin terminal block.

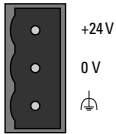

Fig. 3: Pin configuration of 3pin terminal block

## 2. Configuration

### 2.1 CONNECTING DTE AND OTHER NETWORK SEGMENTS

It is possible to connect with

- SPIDER 3TX-TAP up to three
- SPIDER 5TX, SPIDER 5TX EEC up to five
- SPIDER 8TX, SPIDER 8TX EEC up to eight
- SPIDER 1TX/1FX... up to one
- SPIDER 4TX/1FX... up to four data terminal equipments (DTE) or other network segments to the 10/100 Mbit/s ports using twisted pair cabling (ref. Fig. 4).

One further data terminal equipment or optical network component can be connected at 100 Mbit/s to the optical port of the

- SPIDER 1TX/1FX...
- SPIDER 4TX/1FX... using fiber optic cable.

## 3. Assembly, startup procedure and dismantling

### 3.1 UNPACKING, CHECKING

- Check whether the package was delivered complete (see scope of delivery).
- Check the individual parts for transport damage.



#### Warning!

Use only undamaged parts!

### 3.2 ASSEMBLY

The equipment is delivered in a ready-to-operate condition. The following procedure is appropriate for assembly:

- Pull the terminal block off the SPIDER and wire up the supply voltage lines.
- Fit the SPIDER on a 35 mm standard bar to DIN EN 50 022.
- Attach the upper snap-on slide bar of the SPIDER to the standard bar and press it down until it locks in position.
- Fit the signal lines.

#### Notes:

- The SPIDER is grounded via a pin of the terminal block.
- Do not open the housing.
- The shielding ground of the twisted pair lines which can be connected is electrically connected to the ground connection.

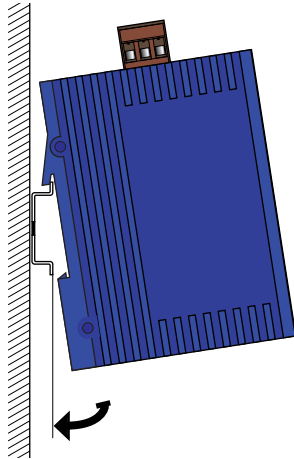

Fig. 5: Assembling the SPIDER

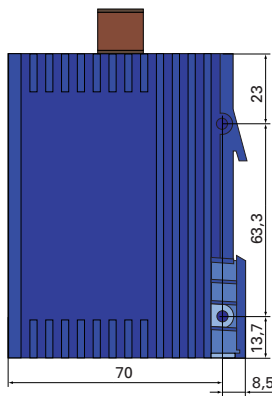

Fig. 6: Dimensions

### 3.3 STARTUP PROCEDURE

- You start up the SPIDER by connecting the supply voltage via the 3-pin terminal block.

### 3.4 DISMANTLING

- To take the SPIDER off the ISO/DIN rail, unlock the snap-in mechanism according to Fig 7.

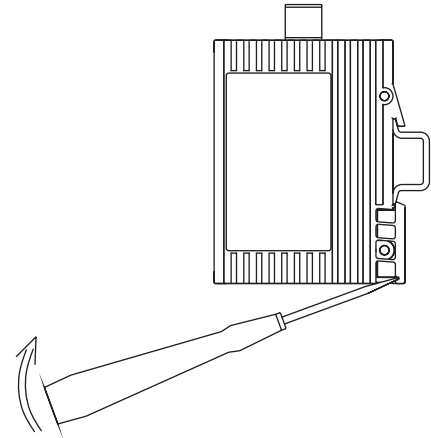

Fig. 7: Dismantling the SPIDER

## 4. Further support

In the event of technical queries, please talk to the Hirschmann contract partner responsible for looking after your account or directly to the Hirschmann office. You can find the addresses of our contract partners – on the Internet

<http://www.hirschmann-ac.com>

Our support line is also at your disposal:  
Tel. +49(1805) 14-1538  
Fax +49(7127) 14-1551

Answers to Frequently Asked Questions can be found on the Hirschmann product site <http://www.hirschmann-ac.com>  
The FAQs are located under „Service“ in the Automation and Network Solutions section.  
[www.hicomcenter.com](http://www.hicomcenter.com) gives you an up-to-date overview of training courses about technology and products.

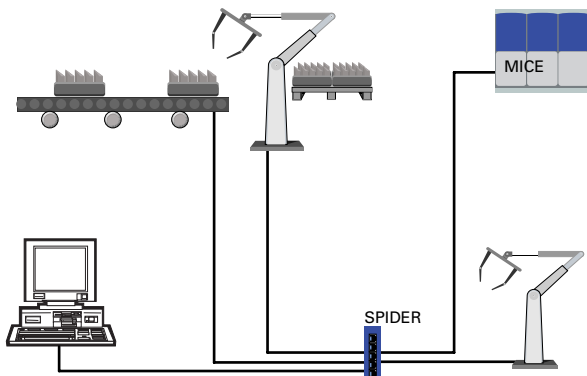

Fig. 4: Configuration with SPIDER: Connection of (depending on product type):

- up to 8 data terminal equipments or further segments via TP
- and up to 1 data terminal equipment or further segment via F/O

## 5. Technical data

### General data

Operating voltage	NEC Class 2 power source 9.6 VDC ... 32.0 VDC safety extra-low voltage (SELV/PELV) 5 A maximum	
Buffer time	min. 10 ms at 20.4 VDC	
Potential difference between input voltage and housing	Potential difference to input voltage, +24 VDC: 32 VDC Potential difference to input voltage, ground: -32 VDC	
Current consumption at 24 VDC	2.2 W maximum; 7.5 Btu (IT)/h 2.2 W maximum; 7.5 Btu (IT)/h 3.9 W maximum; 13.3 Btu (IT)/h 3.0 W maximum; 10.2 Btu (IT)/h 3.9 W maximum; 13.3 Btu (IT)/h	SPIDER 3TX-TAP SPIDER 5TX, SPIDER 5TX EEC SPIDER 8TX, SPIDER 8TX EEC SPIDER 1TX/1FX... SPIDER 4TX/1FX...
Dimensions W x H x D	25 mm x 114 mm x 79 mm (1.0 in x 4.5 in x 3.2 in) 25 mm x 114 mm x 79 mm (1.0 in x 4.5 in x 3.2 in) 40 mm x 114 mm x 79 mm (1.6 in x 4.5 in x 3.2 in) 25 mm x 114 mm x 79 mm (1.0 in x 4.5 in x 3.2 in) 25 mm x 114 mm x 79 mm (1.0 in x 4.5 in x 3.2 in) 25 mm x 126 mm x 79 mm (1.0 in x 5.0 in x 3.2 in)	SPIDER 3TX-TAP  SPIDER 5TX, SPIDER 5TX EEC  SPIDER 8TX, SPIDER 8TX EEC  SPIDER 1TX/1FX...  SPIDER 4TX/1FX, SPIDER 4TX/1FX EEC, SPIDER 4TX/1FX-SM EEC SPIDER 4TX/1FX-ST EEC
Weight	113 g (0.25 lb) 113 g (0.25 lb) 177 g (0.39 lb) 105 g (0.23 lb) 120 g (0.27 lb)	SPIDER 3TX-TAP SPIDER 5TX, SPIDER 5TX EEC SPIDER 8TX, SPIDER 8TX EEC SPIDER 1TX/1FX... SPIDER 4TX/1FX...
Ambient temperature Surrounding air	0 °C to + 60 °C (32 °F to 140 °F)  -40 °C to + 70 °C (-40 °F to 158 °F)  -40 °C to + 75 °C (-40°F to 167°F)	SPIDER 3TX-TAP, SPIDER 5TX, SPIDER 8TX SPIDER 1TX/1FX, SPIDER 1TX/1FX-SM SPIDER 4TX/1FX SPIDER 4TX/1FX EEC, SPIDER 4TX/1FX-ST EEC, SPIDER 4TX/1FX-SM EEC, SPIDER 5TX EEC, SPIDER 8TX EEC SPIDER 1TX/1FX EEC, SPIDER 1TX/1FX-SM EEC
Storage temperature Surrounding air	- 40 °C to + 70 °C (-40 °F to 158 °F)  -40 °C to + 85 °C (-40 °F to 185 °F)	SPIDER 3TX-TAP, SPIDER 5TX, SPIDER 8TX SPIDER 1TX/1FX, SPIDER 1TX/1FX-SM SPIDER 4TX/1FX SPIDER 1TX/1FX EEC, SPIDER 1TX/1FX-SM EEC SPIDER 4TX/1FX EEC, SPIDER 4TX/1FX-ST EEC SPIDER 4TX/1FX-SM EEC, SPIDER 5TX EEC, SPIDER 8TX EEC
Humidity	up to 95% (non condensing)	
Atmospheric pressure	up to 2000 m (795 hPa, higher altitudes on demand)	
Pollution Degree	2	
Laser protectionz	Class 1 conforming to EN 60825-1 (SPIDER 1TX/1FX..., SPIDER 4TX/1FX...)	
Protection type	IP 30	
Interference proof		
Discharge of static electricity		
Contact discharge	EN 61000-4-2 Test level 3	
Air discharge	EN 61000-4-2 Test level 3	
Electromagnetic fields	EN 61000-4-3 Test level 3	
Fast transients	EN 61000-4-4 Test level 3	
Surge voltage symmetrical	EN 61000-4-5 Test level 2	
Surge voltage asymmetrical	EN 61000-4-5 Test level 3	
Cable-based RF faults	EN 61000-4-6 Test level 3	
EMC emitted immunity		
EN 55022	Class A	
FCC 47 CFR Part 15	Class A	
Stability		
Vibration	IEC 60068-2-6 Test FC, testing level in line with EN 61131-2:2003	
Shock	IEC 60068-2-27 Test Ea, testing level in line with EN 61131-2:2003	
Certifications		
cUL 508 / CSA 22.2 No.142	E175531	

### Network size

#### TP port 10BASE-T/100BASE-TX

Length of a twisted pair segment 100 m (328 ft) maximum

#### F/O port 100BASE-FX

According to IEEE 802.3u 100BASE-FX

System attenuation

50/125 µm fiber (multimode MM)	0 to 8 dB	
62,5/125 µm fiber (multimode MM)	0 to 11 dB	
9/125 µm fiber (singlemode)	0 to 16 dB	(SPIDER ...TX/1FX-SM ...)
Wave length (SM)	1300 nm	

**F/O line length (example)**

50/125 µm fiber (multimode MM)	5 km approx.	(data of fiber: 1.0 dB/km, 800 MHz*km)
62,5/125 µm fiber (multimode MM)	4 km approx.	(data of fiber: 1.0 dB/km, 500 MHz*km)
9/125 µm fiber (singlemode SM)	30 km approx.	(data of fiber: 1300 nm, 0.4 dB/km) (SPIDER ...TX/1FX-SM ...)

**Interfaces**

SPIDER 1TX/1FX, SPIDER 1TX/1FX EEC	1 TP/TX port 1 FX port	RJ45 socket, 10/100 MBit/s Duplex SC connection, 100 MBit/s	multimode MM
SPIDER 1TX/1FX-SM, SPIDER 1TX/1FX-SM EEC	1 TP/TX port 1 FX port	RJ45 socket, 10/100 MBit/s Duplex SC connection, 100 MBit/s	singlemode SM
SPIDER 4TX/1FX, SPIDER 4TX/1FX EEC	4 TP/TX ports 1 FX port	RJ45 sockets, 10/100 MBit/s Duplex SC connection, 100 MBit/s	multimode MM
SPIDER 4TX/1FX-ST EEC	4 TP/TX ports 1 FX port	RJ45 sockets, 10/100 MBit/s ST connector, 100 MBit/s	multimode / MM
SPIDER 4TX/1FX-SM EEC	4 TP/TX ports 1 FX port	RJ45 sockets, 10/100 MBit/s Duplex SC connection, 100 MBit/s	singlemode SM
SPIDER 3TX-TAP	3 TP/TX ports	RJ45 sockets, 10/100 MBit/s	
SPIDER 5TX, SPIDER 5TX EEC	5 TP/TX ports	RJ45 sockets, 10/100 MBit/s	
SPIDER 8TX, SPIDER 8TX EEC	8 TP/TX ports	RJ45 sockets, 10/100 MBit/s	

**Displays**

Equipment status	1 x green LED	<b>P</b> – power, supply voltage present
Port status		
SPIDER 1TX/1FX...	2 x green LEDs 1 x yellow LEDs	<b>DA/STAT</b> – data, link status <b>10/100</b> – data rate (TP port)
SPIDER 4TX/1FX...	5 x green LEDs 4 x yellow LEDs	<b>DA/STAT</b> – data, link status <b>10/100</b> – data rate (TP ports)
SPIDER 3TX-TAP	3 x green LEDs 3 x yellow LEDs	<b>DA/STAT</b> – data, link status <b>10/100</b> – data rate
SPIDER 5TX, SPIDER 5TX EEC	5 x green LEDs 5 x yellow LEDs	<b>DA/STAT</b> – data, link status <b>10/100</b> – data rate
SPIDER 8TX, SPIDER 8TX EEC	8 x green LEDs 8 x yellow LEDs	<b>DA/STAT</b> – data, link status <b>10/100</b> – data rate

**Scope of delivery**

Rail Switch SPIDER incl.	terminal block for supply voltage description and operating instructions
--------------------------	---

Order number

Rail Switch SPIDER 3TX-TAP	943 899-001
Rail Switch SPIDER 5TX	943 824-002
Rail Switch SPIDER 5TX EEC	943 824-102
Rail Switch SPIDER 8TX	943 376-001
Rail Switch SPIDER 8TX EEC	943 376-201
Rail Switch SPIDER 1TX/1FX	943 890-001
Rail Switch SPIDER 1TX/1FX EEC	943 927-001
Rail Switch SPIDER 1TX/1FX-SM	943 891-001
Rail Switch SPIDER 1TX/1FX-SM EEC	943 928-001
Rail Switch SPIDER 4TX/1FX	943 221-001
Rail Switch SPIDER 4TX/1FX EEC	943 221-101
Rail Switch SPIDER 4TX/1FX-ST EEC	943 914-001
Rail Switch SPIDER 4TX/1FX-SM EEC	943 880-001

**Accessories**

ETHERNET manual	943 320-011
Manual	
Basics Industrial ETHERNET and TCP/IP	280 720-834
Rail Power Supply RPS 30	943 662-003
Rail Power Supply RPS 60	943 662-001
Rail Power Supply RPS 120	943 662-011

Hirschmann Automation and Control GmbH  
 Stuttgarter Straße 45-51  
 D-72654 Neckartenzlingen  
 Germany  
 Tel.: ++49 / 1805 / 14-1538  
 Fax: ++49 / 7127 / 14-1551  
 E-Mail: hac-support@hirschmann.de  
 Internet: http://www.hirschmann.com

Printed in Germany  
 Subject to alterations