

Magnetically Compensated Choke, 1-phase, high design



Description

- Current compensated choke
- 1-phase choke
- THT-terminals
- Inductor vertically positioned in housing

Standards

- EN 60938
- UL 1283
- CSA 22.2 no 8

Approvals

- Approval Reference Type: DFKH

Applications

- Attenuation of common mode interferences
- Designed for 230/400 VAC applications
- Chopper amplifiers
- DC drives and stepper motor controls
- Switching power supplies

Weblinks

[pdf datasheet](#), [html-datasheet](#), [General Product Information](#), [Approvals](#), [CE declaration of conformity](#), [RoHS](#), [CHINA-RoHS](#), [REACH](#), [Distributor-Stock-Check](#), [Detailed request for product](#), [SPICE Library](#)

Technical Data

Rated voltage	up to 440 VAC
Rated Current	0.6 - 6.3 A @ Ta 40 °C
Rated inductance	0.6 - 50 mH, Tol. -30% +50%
Power Operating Frequency	50 - 400 Hz
Terminal Type	THT
Weight	3 - 30 g
Material: Housing	UL 94V-0
Sealing Compound	UL 94V-0

Test Voltage	1.8 kV, 50 Hz, 1 min., winding to winding
Isolation Voltage	2 kV eff., winding to ambient
Climatic Category	25/100/21 acc. to IEC 60068-1
Allowable Operation Temp.	-25 °C to 100 °C

Detailed information on product approvals, code requirements, usage instructions and detailed test conditions can be looked up in [General Product Information](#)

Dimension

Case 50-2, 51-2, 52-2

Case 09-2

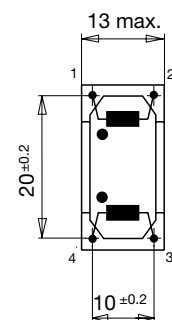
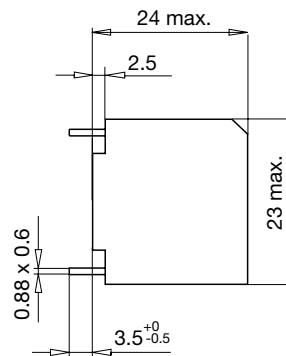
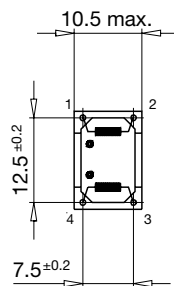
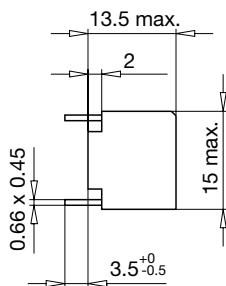

Case 19-2

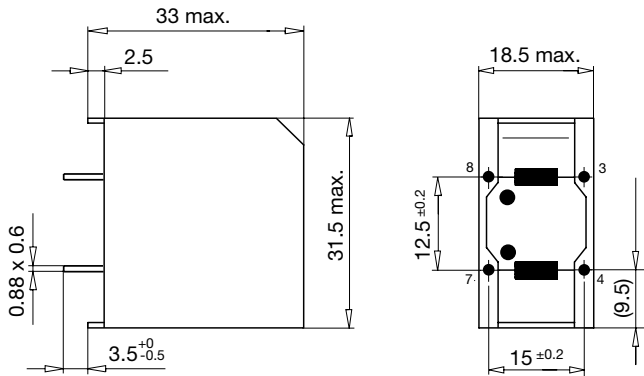

Impedance curves

DFKH-14-xxxx

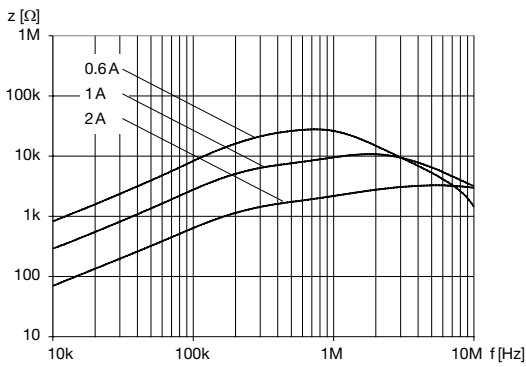

DFKH-22-xxxx

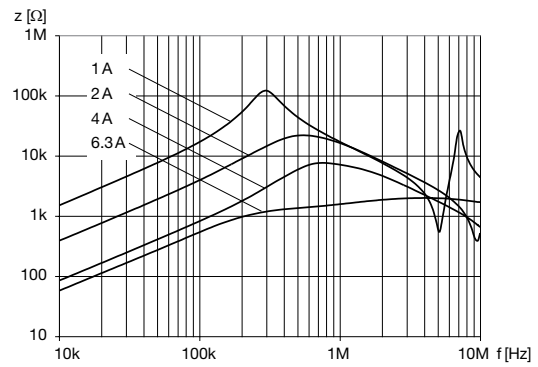

DFKH-31-xxxx

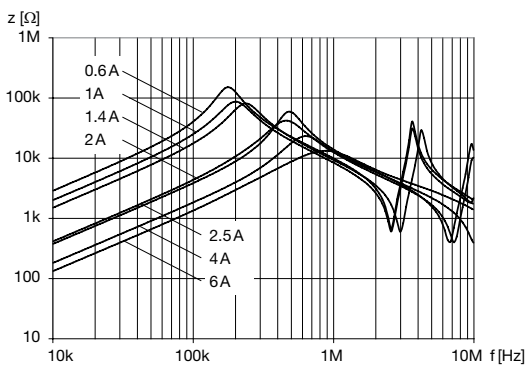

All Variants

I_n [A]	L_n [mH]	R_{cu} [mΩ]	Power _{loss} [W]	f_{RES} [MHz]	Weight [g]	Housings	Packing unit [pcs.]	Order Number
0.6	11	600	0.5	0.5	3g	50-2	100	DFKH-14-0001
0.6	50	1200	0.9	0.15	22g	19-2	70	DFKH-31-0001
1	20	500	1	0.25	10g	09-2	50	DFKH-22-0002
1	33	700	1.4	0.25	30g	19-2	70	DFKH-31-0002
1	4	250	0.5	1.2	3g	51-2	100	DFKH-14-0002
1.4	27	470	1.8	0.3	30g	19-2	70	DFKH-31-0003
2	1	65	0.5	2.5	3g	52-2	100	DFKH-14-0003

I_n [A]	L_n [mH]	R_{cu} [mΩ]	Power _{loss} [W]	f_{RES} [MHz]	Weight [g]	Housings	Packing unit [pcs.]	Order Number
2	6	150	1.3	0.6	10 g	09-2	50	DFKH-22-0003
2	6.8	150	1.2	0.5	30 g	19-2	70	DFKH-31-0005
2.5	5.6	110	-	-	30 g	19-2	70	DFKH-31-0006
4	1.5	36	1.2	1.5	10 g	09-2	50	DFKH-22-0004
4	3.3	58	1.8	0.8	30 g	19-2	70	DFKH-31-0007
6	2	24	1.8	1.2	30 g	19-2	70	DFKH-31-0008
6.3	0.6	15	1.4	2.5	10 g	09-2	50	DFKH-22-0005

Most Popular.

Availability for all products can be searched real-time: <http://www.schurter.com/en/Stock-Check/Stock-Check-SCHURTER>