

**ebm-papst St. Georgen GmbH & Co. KG**

Hermann-Papst-Str. 1

D-78112 St. Georgen

Phone +49 (0) 7724 81-0

Fax +49 (0) 7724 81-1309

info2@de.ebmpapst.com

www.ebmpapst.com

**Nominal data**

Type	3900	
Phase		1~
Nominal voltage	VAC	115
Frequency	Hz	60
Speed (rpm)	min <sup>-1</sup>	3150
Power consumption	W	9.0
Min. ambient temperature	°C	-20
Max. ambient temperature	°C	80
Air flow	m <sup>3</sup> /h	70
Sound power level	B	5.1
Sound pressure level	dB(A)	40

ml = Max. load · me = Max. efficiency · fa = Free air · cs = Customer specification · ce = Customer equipment  
Subject to change



**Technical description**

<b>Weight</b>	0.280 kg
<b>Dimensions</b>	92 x 92 x 25 mm
<b>Impeller material</b>	Mineral-reinforced PA plastic
<b>Housing material</b>	Die-cast aluminum
<b>Part no.</b>	9282708116
<b>Airflow direction</b>	Exhaust over struts
<b>Direction of rotation</b>	Counterclockwise, viewed toward rotor
<b>Storage</b>	Sintec sleeve bearing
<b>Service life L10 at 40 °C</b>	60000 h
<b>Service life L10 at maximum temperature</b>	22500 h
<b>Cable</b>	2 flat plugs 2.8 x 0.5 mm. Housing with grounding lug for M4 screw.
<b>Motor protection</b>	Protected from overload by impedance protection
<b>Approval</b>	VDE, CSA, UL, CE

## Product drawing

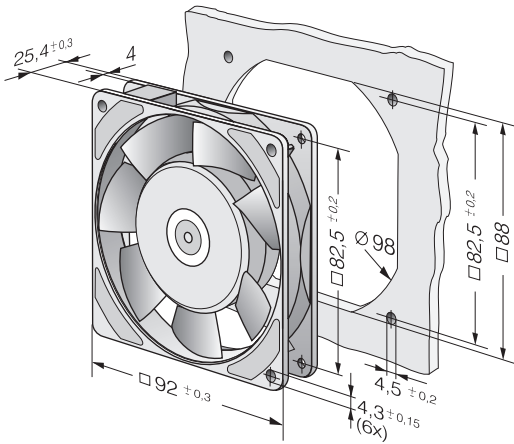

## Curves: Air performance

