

LID

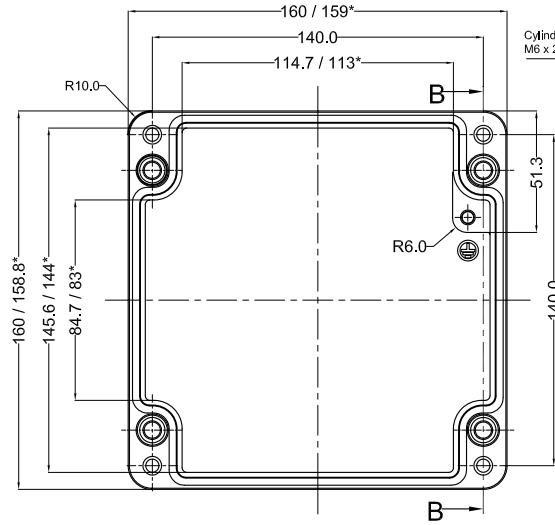

Cylinder Screw
M6 x 25/10 similar to DIN 84

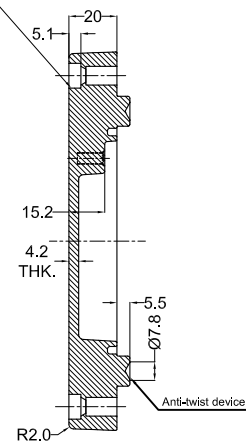

SECTION B-B

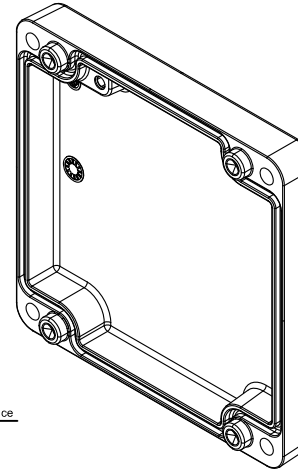

* = Conical form tapering downward.
Untoleranced dimensions per GTA 13/5 - DIN 1688

ACCESSORIES		
PART NAME	QTY.	AVILABILITY
MOUNTING PLATE	1	Y
EXTERNAL HINGE	2	Y
INTERNAL HINGE	2	Y
MOUNTING BRACKETS	4	Y
NEOPRENE/SILICON GASKET	1	Y
DIN RAIL TS15	-	N
DIN RAIL TS35	1	Y

BASE

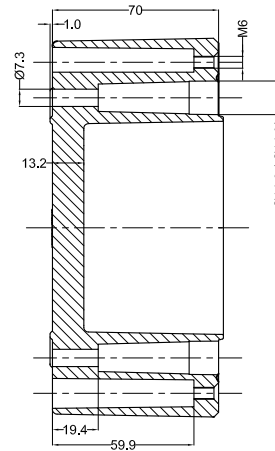
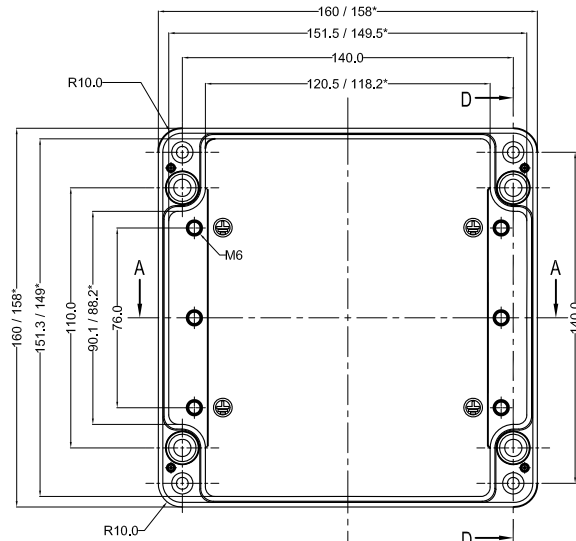

SECTION D-D

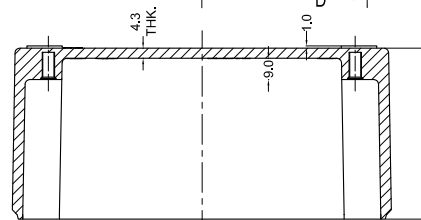
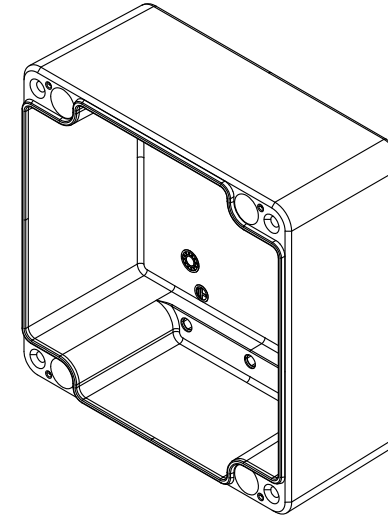

SECTION A-A

PROPERTY OF RaychemRPG (P) LTD.
ALL RIGHTS RESERVED AND/OR PHOTOCOPYING THIS DOCUMENT
TO A PERSON WITHOUT RaychemRPG (P)LTD. WRITTEN AUTHORIZATION IS PROHIBITED

QUANTITY 1	MATERIAL :- AlSi12 DIN230	MACH.NAME -	DATE 08/05/12	SIGN MANOJ	NAME DRAWN
TOLERANCE ±0.2 DIMENSIONS ±0.2 HOLES ±1.0° ANGLES		WEIGHT: FINISH: - NATURAL	TITLE :- JUNCTION BOX 160 x 160 x 91	DATE 08/05/12	NAME PAVAN CHECKED
ALL DIMENSION ARE IN MM		Raychem RPG (P) Limited	SCALE	PARTNO. 0	
RJ 15		Ceat Mahal Annexe, Dr. Annie Besant Road , Worli , Mumbai 400030 Web : www.raychemrpg.com	REV 0	DRG. NO. AJB-16016091	