

Single phase - general purpose

Comprehensive family of single and multi-stage chassis mount filters. Throughout the power range, a high level of performance is provided within various sizes and styles of metal enclosure and termination options.

Designed to provide economic solutions to a multitude of general purpose filtering requirements; industrial power equipment, office, business and medical equipments.

The two stage FAS series is specifically designed to suppress RFI generated by switch mode power supply applications.

- Current ratings from 0.5A to 40A
- High symmetric and asymmetric attenuation
- Earth line choke and medical versions available
- Custom designs to client specifications

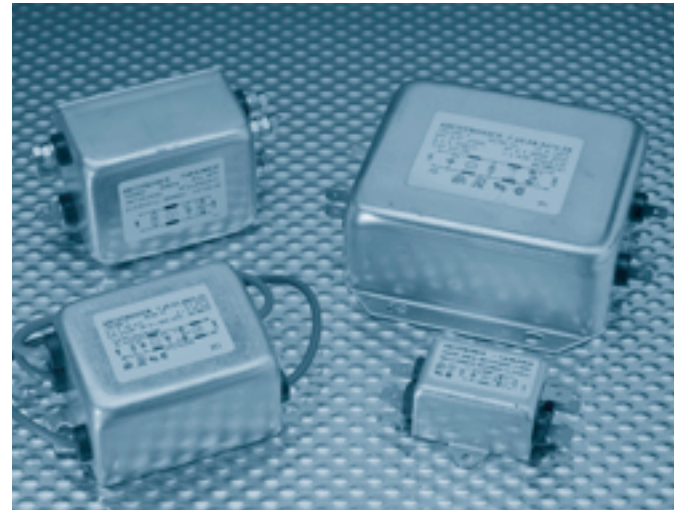

Mechanical Specifications

Manufacture: metal case and cover, internal components sealed with self-extinguishing resin.

Connections: faston 6.3 x 0.8mm ($\leq 16A$),
flexible leads, screws M4 ($\leq 40A$)
ground terminal connected to case.

Electrical Specifications

Rated voltage (V_R): max 250V, 50/60Hz

Rated current (I_R): referred to room temperature = 40°C

Leakage current (I_L): at 220V, 50Hz, max value

Voltage test (2_s): line to ground 3000Vdc or 1800Vac
line to line 1700Vdc

Climatic category: HPF (25/085/21);

Temperature range: -25°C to +85°C

Dimensions (mm)

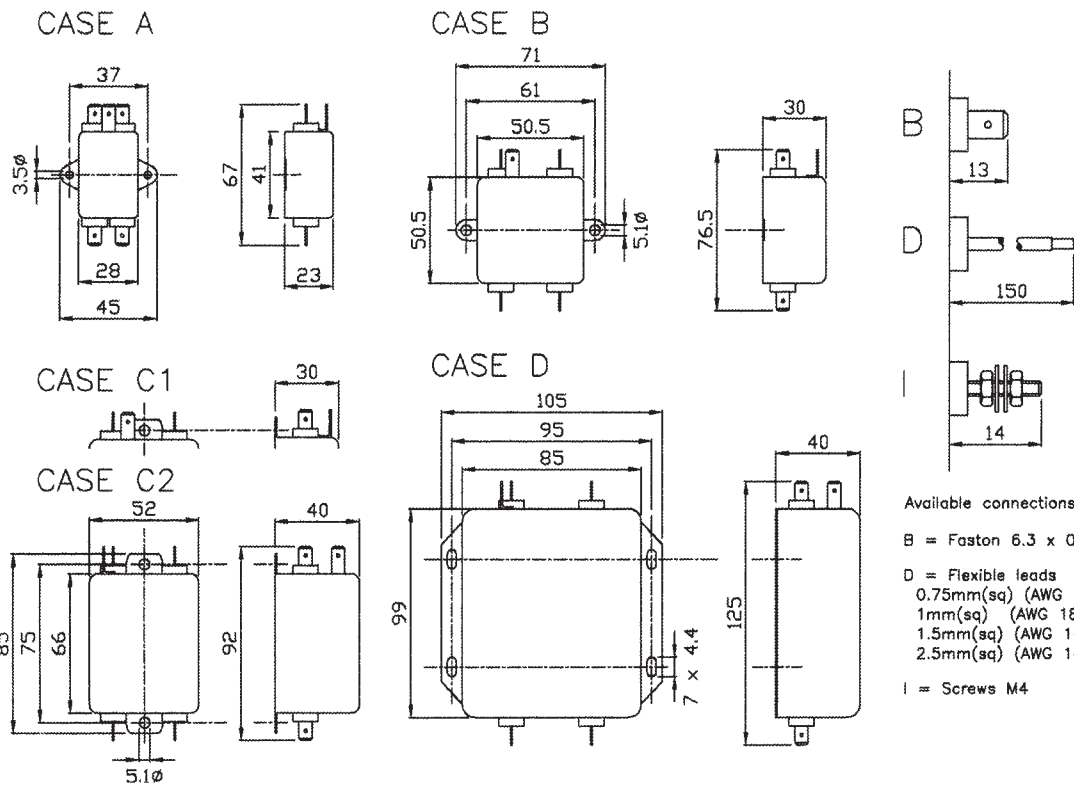

Available connections

B = Faston 6.3 x 0.8 ($\leq 16A$)

D = Flexible leads
0.75mm(sq) (AWG 20) for $I_r \leq 2A$
1mm(sq) (AWG 18) for $2A < I_r \leq 3A$
1.5mm(sq) (AWG 16) for $3A < I_r \leq 9A$
2.5mm(sq) (AWG 14) for $I_r > 9A$

I = Screws M4

Chassis Mount Filters

F.AI-F.AM-F.AK-F.AR-F.AS series

Filter Range

F.AI Code	I _r (A)	L (mH)	C _x (μF)	C _y (pF)	I _L (mA)	R (MΩ)	Circ Diag	Case
F.AI.DB.2150.ZA	1.5	2x10	0.015	2x2200	2x0.2		A	A
F.AI.DB.2150.ZB	1	2x10	0.015	2x2200	2x0.2		A	A
F.AI.DB.2150.ZC	3	2x2	0.015	2x2200	2x0.2		A	A
F.AI.DB.2150.ZD	6.5	2x1	0.015	2x2200	2x0.2		A	A
F.AI.D-.2330.ZA	10	2x0.5	0.033	2x2200	2x0.2	1	B	B
F.AI.D-.2330.ZB	20	2x0.5	0.033	2x2200	2x0.2	1	B	B
F.AI.D-.2330.ZC	30	2x0.6	0.033	2x2200	2x0.2	1	B	D
F.AI.D-.3100.ZA	5	2x1	0.1	2x3200	2x0.29	1	B	B
F.AI.D-.3100.ZB	5	2x1.7	0.1	2x3200	2x0.29	1	B	B

B = Faston 6.3x0.8 mm
D = Flexible leads
I = Screws M4

FIL2150 = F.AI.DB.2150.ZA
FIL2150-3 = F.AI.DB.2150.ZC
FIL2150-6,5 = F.AI.DB.2150.ZD
FIL2150-10 = F.AI.DB.2330.ZA

F.AK Code	I _r (A)	L ₁ (mH)	L ₂ (mH)	C _{x1} (μF)	C _{x2} (μF)	C _{x3} (pF)	C _{y1} (pF)	C _{y2} (pF)	I _L (mA)	R (MΩ)	Circ Diag	Case
FAK.D-.3300.ZA	3	2x2	2x2	0.15	0.15		2x2200		2x0.2	1	E	C1
FAK.D-.3300.ZB	6	2x1	2x1	0.15	0.15		2x2200		2x0.2	1	E	C1
FAK.D-.3300.ZC	10	2x0.5	2x0.5	0.15	0.15		2x2200		2x0.2	1	E	C2
FAK.D-.3300.ZD	20	2x0.5	2x0.5	0.15	0.15		2x2200		2x0.2	1	E	D
FAK.D-.3570.ZA	2.5	2x1	2x25		0.47	0.1	2x3300	2x3300	2x0.6	0.68	E	D
FAK.D-.3810.ZA	10	2x2.3	2x2.3	0.27	0.27	0.27	2x5500	2x1000	2x0.6	0.33	E	D
FAK.D-.3940.ZA	3	2x4.7	2x4.7	0.47	0.47		2x4700		2x0.5	0.24	F	C2

B = Faston 6.3x0.8 mm
D = Flexible leads
I = Screws M4

■ UL approval only

F.AM Code	I _r (A)	L (mH)	C _{x1} (μF)	C _{x2} (μF)	C _y (pF)	I _L (mA)	R (MΩ)	Circ Diag	Case
F.AM.D-.3200.ZA	1	2x40	0.1	0.1	2x4700	2x0.43	0.68	C	B
F.AM.D-.3200.ZB	5	2x1	0.1	0.1	2x3200	2x0.29	0.68	C	B
F.AM.D-.3200.ZC	10	2x0.5	0.1	0.1	2x2200	2x0.20	0.68	C	B
F.AM.D-.3200.ZD	20	2x0.5	0.1	0.1	2x2200	2x0.20	0.68	C	C2
F.AM.D-.3200.ZE	30	2x0.6	0.1	0.1	2x2200	2x0.20	0.68	C	D
▲ F.AM.D-.3440.ZA	10	2x1	0.22	0.22	2x4700	2x0.43	0.47	D	B
F.AM.D-.3470.ZA	6.5	2x4		0.47	2x1000	2x0.09	0.68	C	C2
F.AM.D-.3600.ZC	16	2x1		0.6	2x2500	2x0.23	0.47	C	C2
F.AM.D-.3600.ZD	22	2x0.2		0.6	2x2500	2x0.23	0.47	C	C2
▲ F.AM.D-.3600.ZE	20	2x1		0.6	2x4700	2x0.43	0.47	D	C2
▲ F.AM.D-.3600.ZF	40	2x0.23		0.6	2x4700	2x0.43	0.47	D	C2
▲ F.AM.D-.3600.ZH	30	2x0.23		0.6	2x4700	2x0.43	0.47	D	C2
▲ F.AM.D-.3600.ZK	25	2x0.5	0.6		2x4700	2x0.43	0.47	D	C2
▲ F.AM.D-.3600.ZL	25	2x0.5	0.6		2x22000	2x2.0	0.47	D	C2
F.AM.D-.3940.ZA	4.5	2x20	0.47	0.47	2x10000	2x0.91	0.33	C	C2
F.AM.D-.3940.ZB	3.3	2x13	0.47	0.47	2x6800	2x0.62	0.33	C	C2
■ F.AM.D-.4100.ZB	16	2x0.5		1.0	2x2500	2x0.23	0.33	D	C2
▲ F.AM.D-.4160.ZA	25	2x0.5	1.0	0.68	2x22000	2x2.0	0.47	C	C2

B = Faston 6.3x0.8mm
D = Flexible leads
I = Screws M4

▲ no approvals
■ UL approval only

Circuit diagram

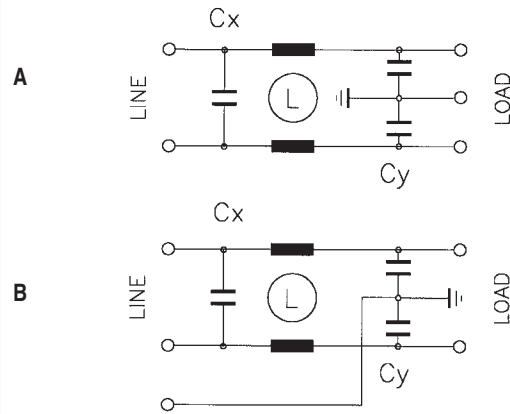

Circuit diagram

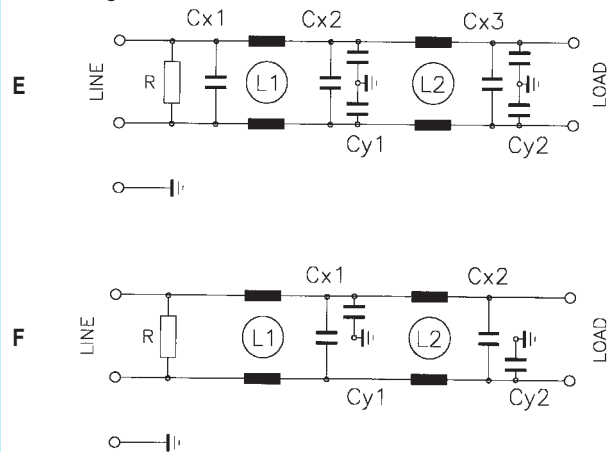

Circuit diagram

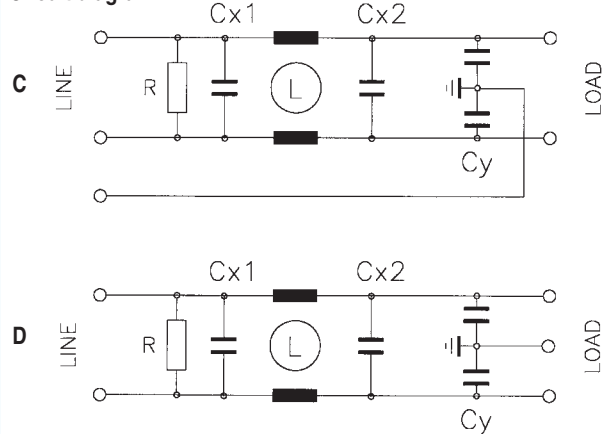

FIL3600 = F.AM.DB.3600.ZC
FIL3640 = F.AM.DB.3600.ZF

Chassis Mount Filters

F.AI-F.AM-F.AK-F.AR-F.AS series

F.AR Code	I _R (A)	L ₁ (mH)	L ₂ (mH)	C _{x1} (μF)	C _{x2} (μF)	C _{y1} (pF)	C _{y2} (pF)	I _L (mA)	R (MΩ)	Circ	Case
F.AR.D-.3620.ZA	1.5	2x7	2x7	0.47	0.15		2x2200	2x0.2	0.47	G	C2
F.AR.D-.3620.ZB	2.5	2x12	2x2	0.47	0.15		2x2200	2x0.2	0.47	G	C2
F.AR.D-.3620.ZC	5	2x7	2x7	0.47	0.15		2x2200	2x0.2	0.47	G	C2
F.AR.D-.3620.ZD	8.5	2x10	2x3	0.47	0.15		2x2200	2x0.2	0.47	G	D
▲ F.AR.D-.3940.ZA	0.5	2x40	2x40	0.47	0.47		2x3300	2x0.3	0.33	G	C1

B = Faston 6.3x0.8mm
 D = Flexible leads
 I = Screws M4

▲ No approvals

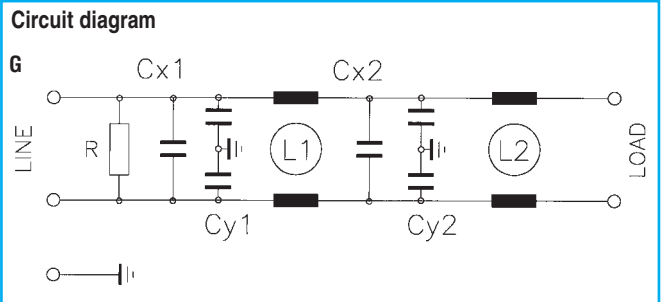

F.AS Code	I _R (A)	L ₁ (mH)	L ₂ (mH)	C _{x1} (μF)	C _y (pF)	I _L (mA)	R (MΩ)	Circ	Case
F.AS.D-.3220.ZA	1	2x22	2x0.3	0.22	2x4700	2x0.43	1	H	B
F.AS.D-.3220.ZB	2.5	2x16	2x0.3	0.22	2x4700	2x0.43	1	H	C2
F.AS.D-.3470.ZA	6.5	2x4	2x0.05	0.47	2x22000	2x2	0.47	H	D
F.AS.D-.3470.ZB	10	2x4	2x0.05	0.47	2x22000	2x2	0.47	H	D
F.AS.D-.3940.ZA	4	2x8	2x0.05	0.94	2x22000	2x2	0.33	H	C2
▲ F.AS.D-.3940.ZC	10	2x4	2x0.05	2x0.47	2x22000	2x2	0.33	H	D

B = Faston 6.3x0.8mm
 D = Flexible leads
 I = Screws M4

▲ No approvals

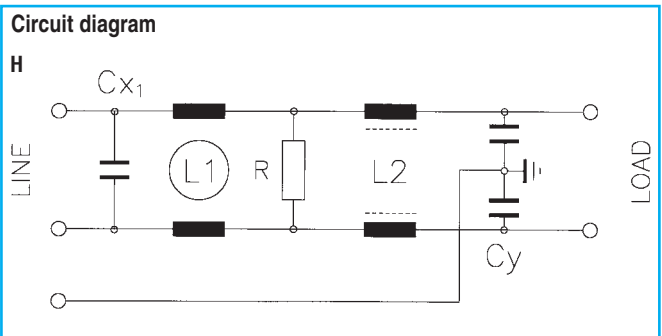

F.AI

Insertion loss (typical): — Asymmetrical (line to ground) - - - Symmetrical (line to line)

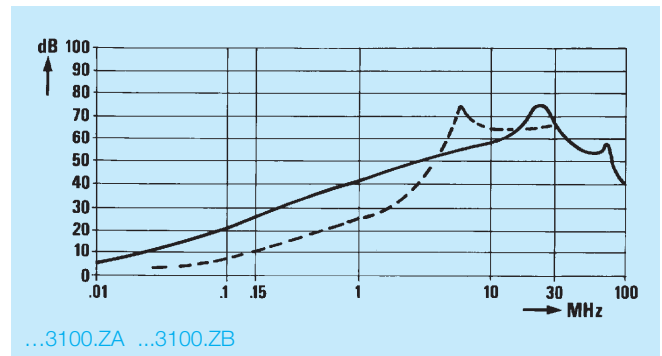
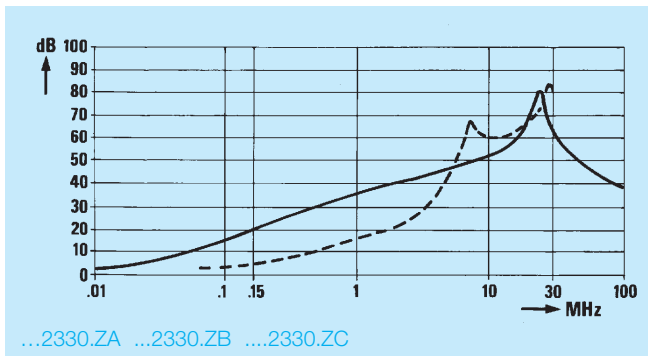
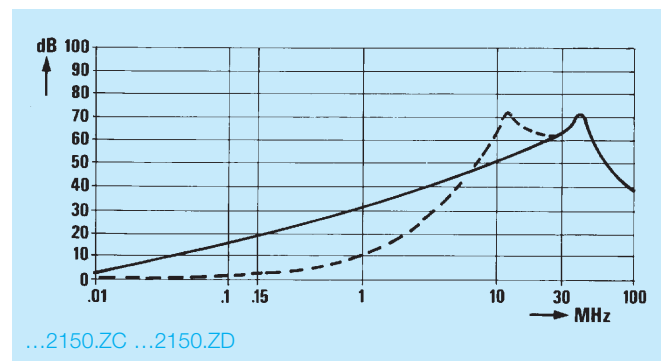
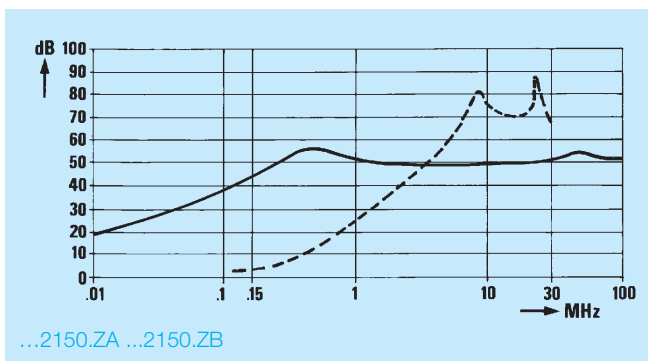

Approvals



F.AK

Insertion loss (typical): — Asymmetrical (line to ground) - - - Symmetrical (line to line)

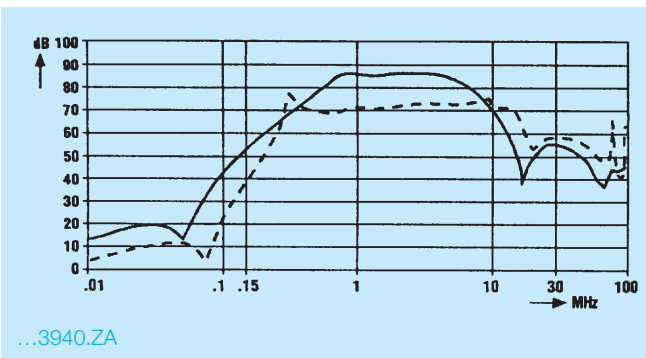
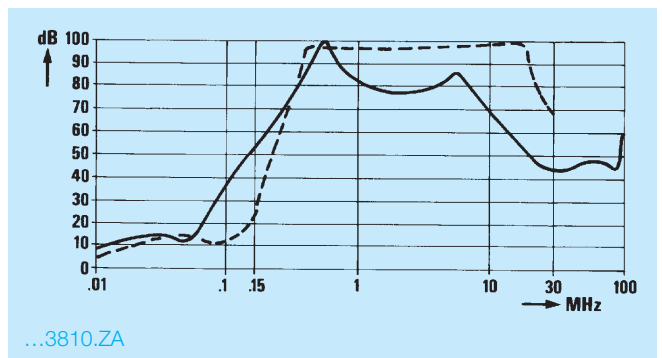
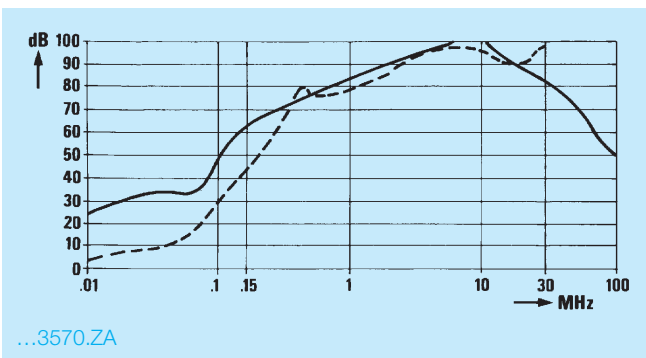
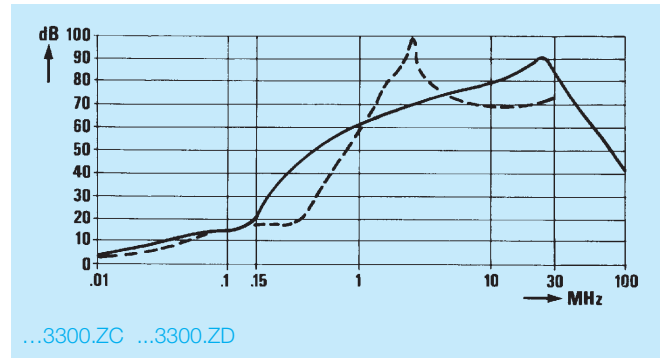
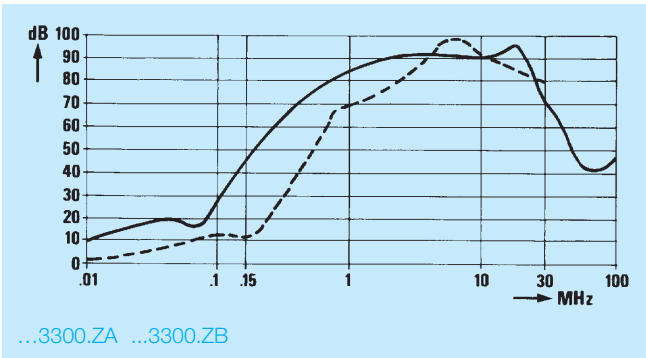

F.AM

Insertion loss (typical): — Asymmetrical (line to ground) - - - Symmetrical (line to line)

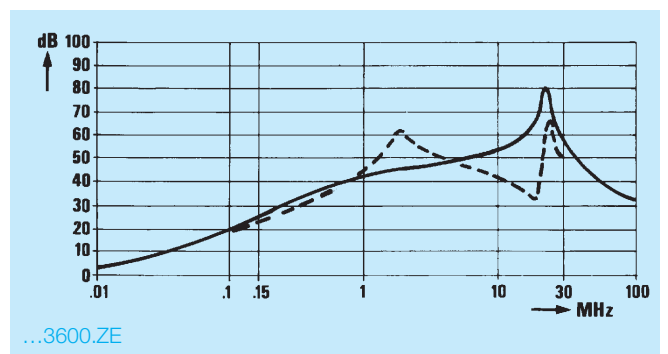
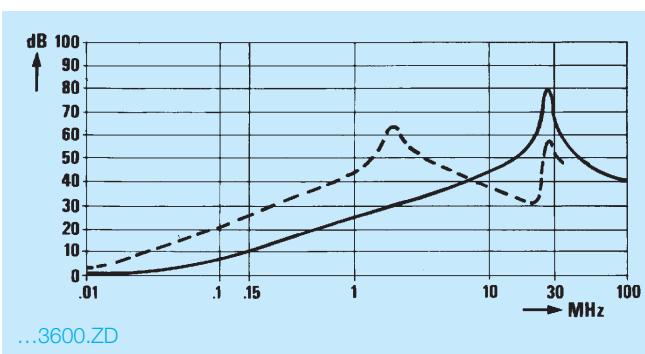
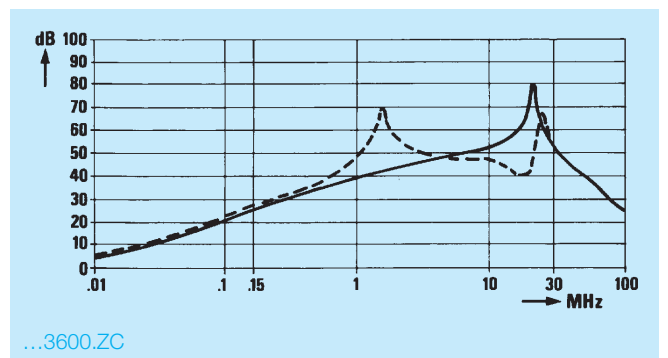
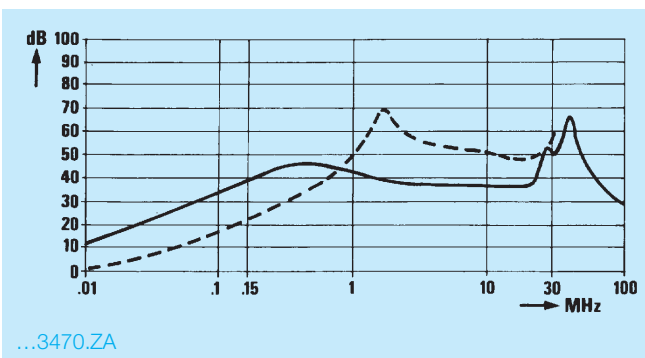
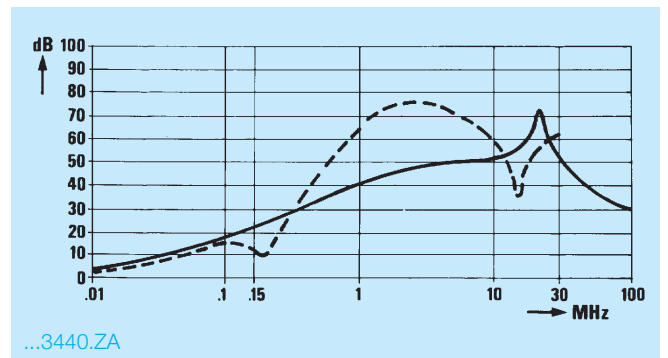
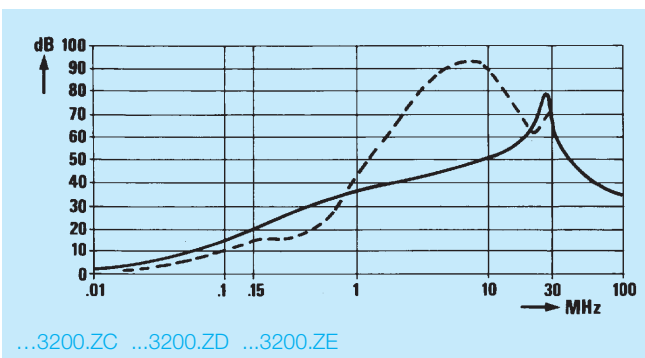
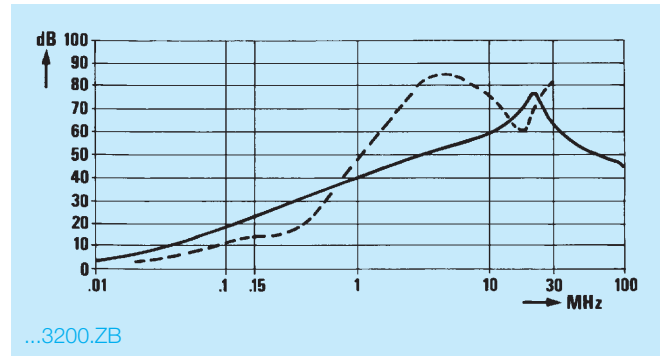
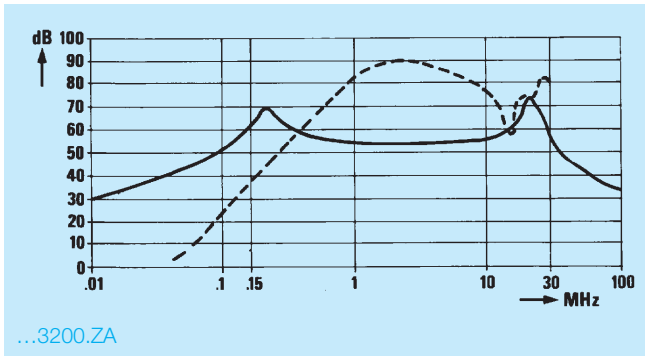

Chassis Mount Filters

F.AI-F.AM-F.AK-F.AR-F.AS series

Insertion loss (typical): — Asymmetrical (line to ground) - - - Symmetrical (line to line)

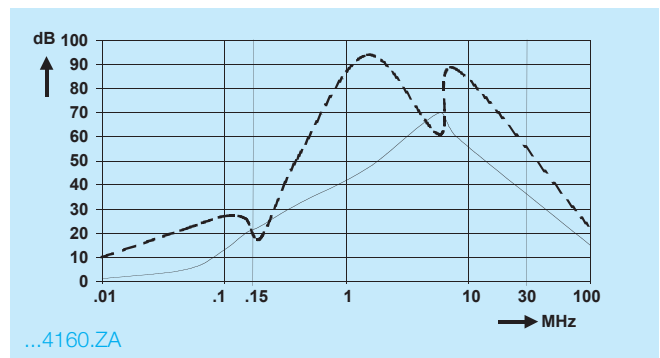
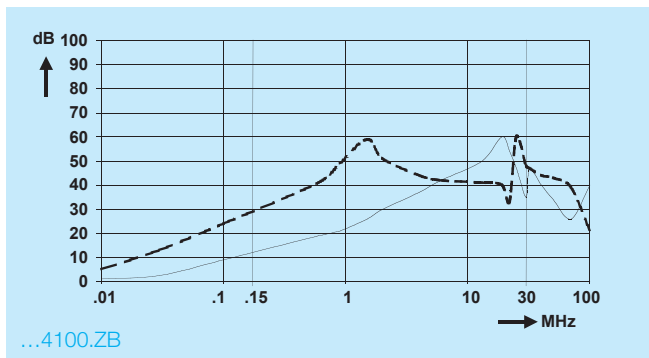
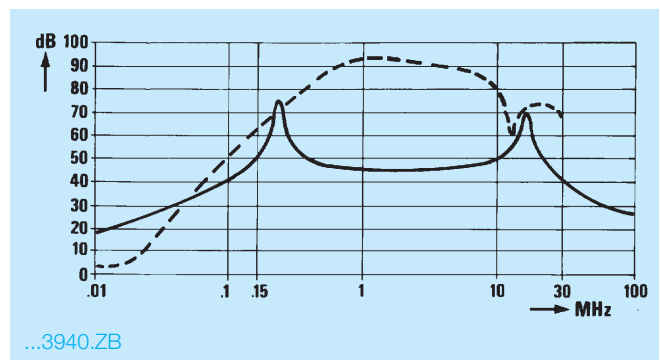
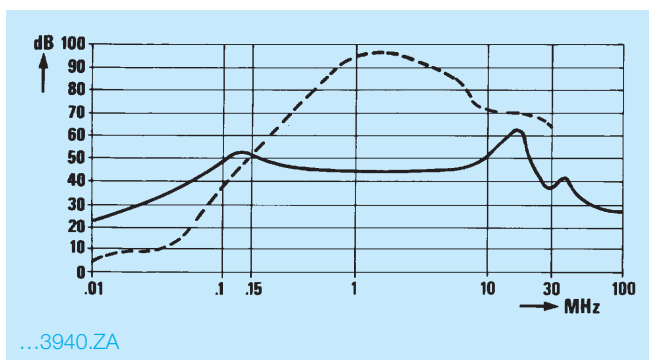
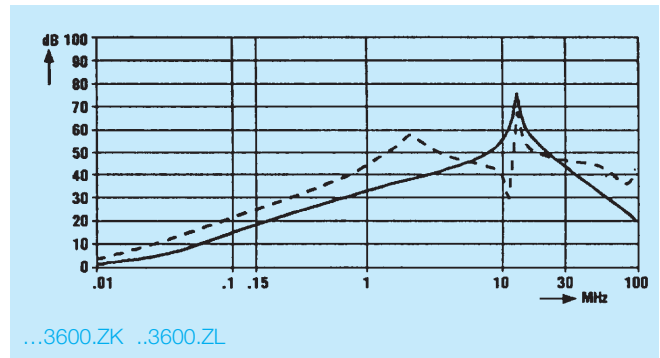
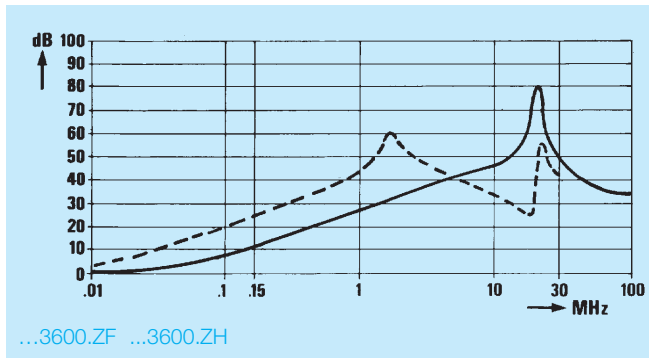

F.AR

Insertion loss (typical): — Asymmetrical (line to ground) - - - Symmetrical (line to line)

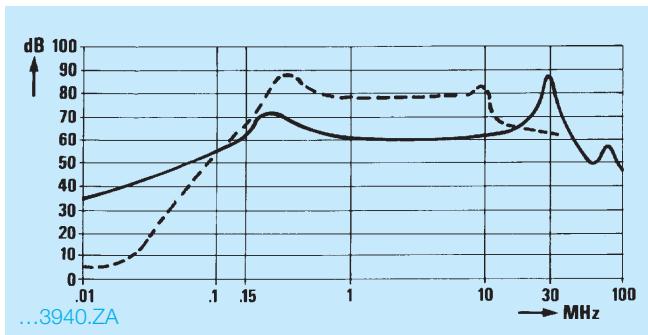
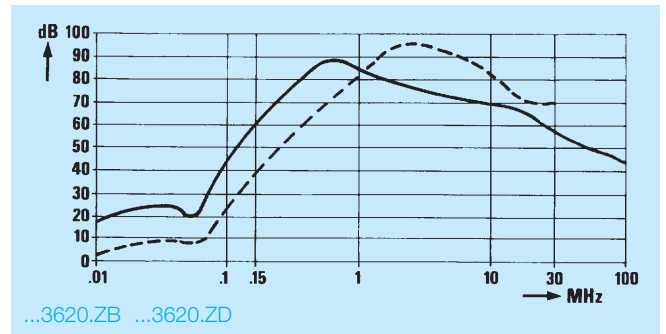
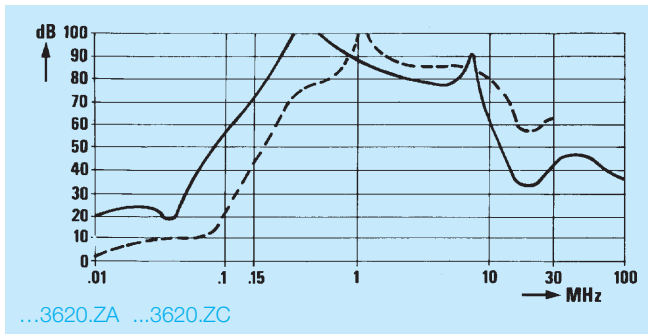

F.AS

