

PC355NT

Mini-Flat Package, High Sensitivity Photocoupler

■ Features

1. High current transfer ratio
(CTR : MIN. 600% at $I_F = 1\text{mA}$, $V_{CE} = 2\text{V}$)
2. Opaque type, mini-flat package
PC355NT (1-channel)
3. Subminiature type
(The volume is smaller than that of our conventional DIP type by as far as 30%)
4. Isolation voltage between input and output
PC355NT•••Viso : 3 750V_{rms}
5. Recognized by UL (NO. E64380)

■ Package Specifications

Model No.	Taping specifications
PC355NT	Taping reel diameter 178mm (750pcs.)

■ Applications

1. Hybrid substrates that require high density mounting.
2. Programmable controllers

■ Outline Dimensions

(Unit : mm)

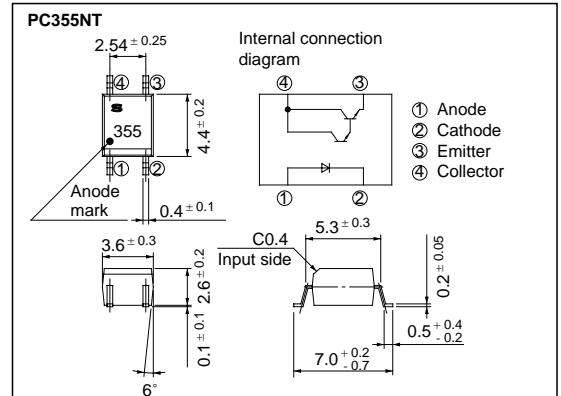

Absolute Maximum Ratings

(Ta = 25°C)

Parameter		Symbol	Rating	Unit
Input	Forward current	I _F	50	mA
	*1 Peak forward current	I _{FM}	1	A
	Reverse voltage	V _R	6	V
	Power dissipation	P	70	mW
Output	Collector-emitter voltage	V _{CEO}	35	V
	Emitter-collector voltage	V _{ECO}	6	V
	Collector current	I _C	80	mA
	Collector power dissipation	P _C	150	mW
Total power dissipation		P _{tot}	170	mW
*2 Isolation voltage		V _{iso}	3 750	V _{rms}
Operating temperature		T _{opr}	- 30 to + 100	°C
Storage temperature		T _{stg}	- 40 to + 125	°C
*3 Soldering temperature		T _{sol}	260	°C

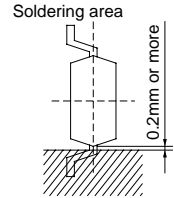

*1 Pulse width <= 100 μs, Duty ratio : 0.001

*2 40 to 60% RH, AC for 1 minute

*3 For 10 seconds

Electro-optical Characteristics

(Ta = 25°C)

Parameter		Symbol	Conditions	MIN.	TYP.	MAX.	Unit	
Input	Forward voltage	V _F	I _F = 20mA	-	1.2	1.4	V	
	Reverse current	I _R	V _R = 4V	-	-	10	μ A	
	Terminal capacitance	C _t	V = 0, f = 1kHz	-	30	250	pF	
Output	Collector dark current	I _{CEO}	V _{CE} = 10V, I _F = 0	-	-	10 ⁻⁶	A	
	Collector-emitter breakdown voltage	BV _{CEO}	I _C = 0.1mA, I _F = 0	35	-	-	V	
	Emitter-collector breakdown voltage	BV _{ECO}	I _E = 10 μA, I _F = 0	6	-	-	V	
Transfer-characteristics	Current transfer ratio	CTR	I _F = 1mA, V _{CE} = 2V	600	1 600	7 500	%	
	Collector-emitter saturation voltage	V _{CE(sat)}	I _F = 20mA, I _C = 1mA	-	0.8	1.0	V	
	Isolation resistance	R _{ISO}	DC500V, 40 to 60% RH	5 x 10 ¹⁰	10 ¹¹	-	Ω	
	Floating capacitance	C _f	V = 0, f = 1MHz	-	0.6	1.0	pF	
	Response time	Rise time	t _r	V _{CE} = 2V, I _C = 2mA	-	60	300	μ s
		Fall time	t _f	R _L = 100Ω	-	53	250	μ s

Fig. 1 Forward Current vs. Ambient Temperature

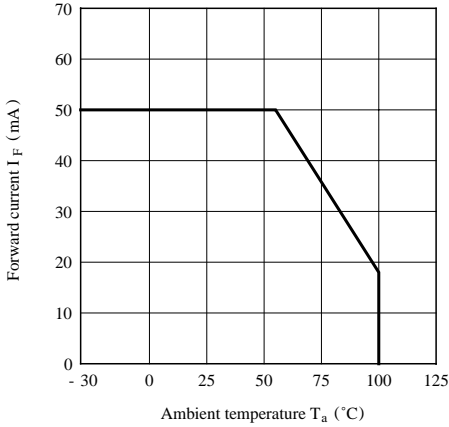

Fig. 2 Diode Power Dissipation vs. Ambient Temperature

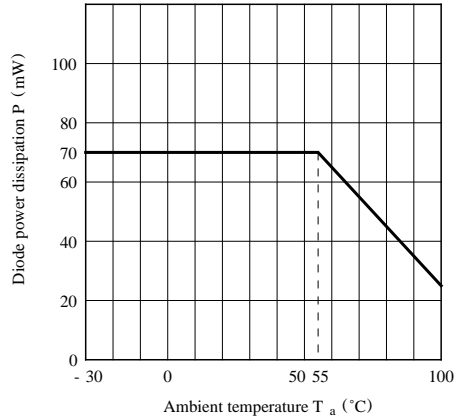

Fig. 3 Collector Power Dissipation vs. Ambient Temperature

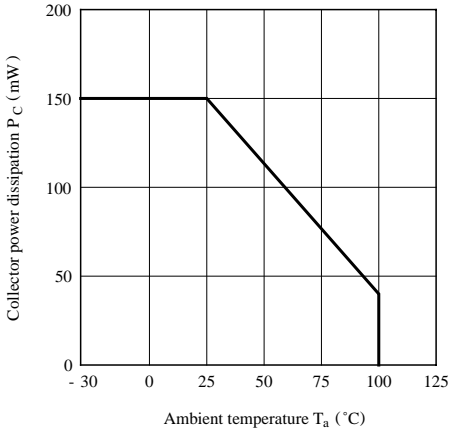

Fig. 4 Total Power Dissipation vs. Ambient Temperature

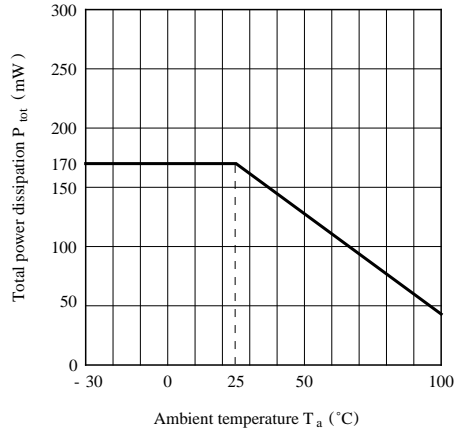

Fig. 5 Peak Forward Current vs. Duty Ratio

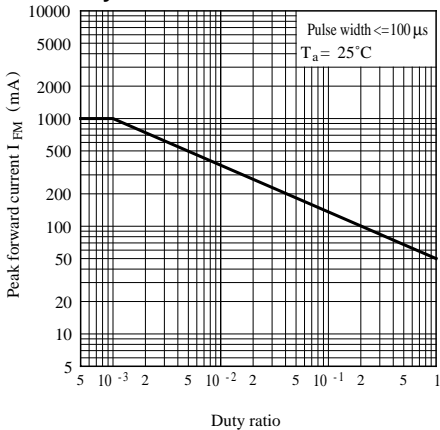

Fig. 6 Forward Current vs. Forward Voltage

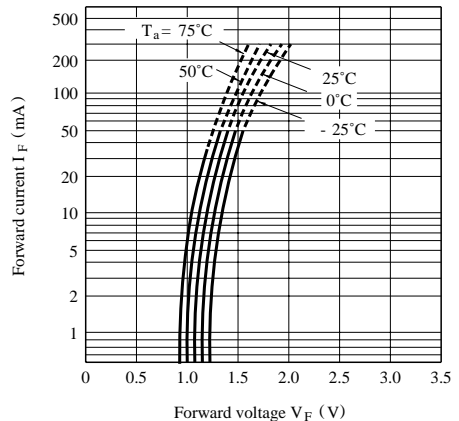

Fig. 7 Current Transfer Ratio vs. Forward Current

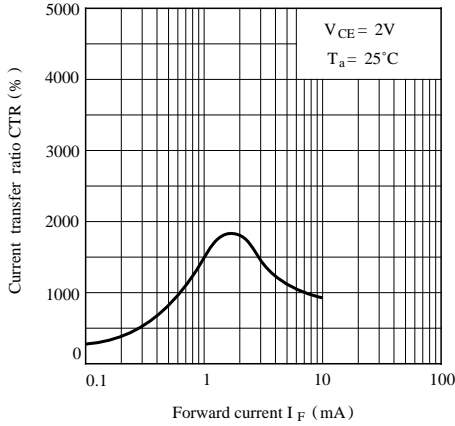

Fig. 8 Collector Current vs. Collector-emitter Voltage

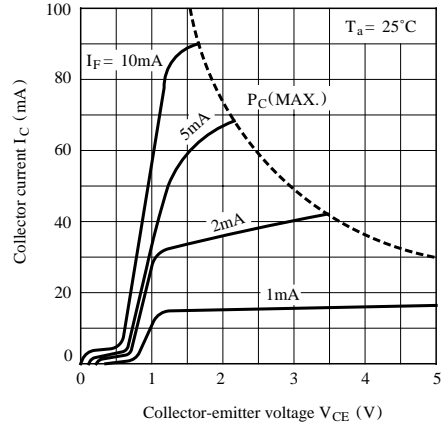

Fig. 9 Relative Current Transfer Ratio vs. Ambient Temperature

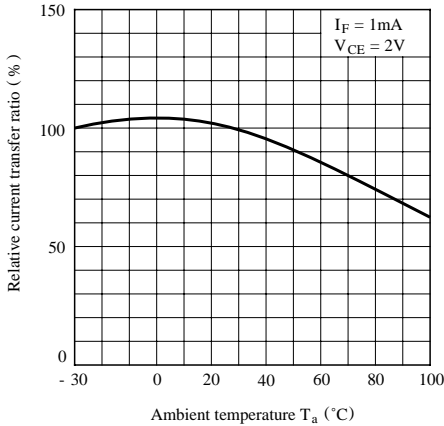

Fig.10 Collector-emitter Saturation Voltage vs. Ambient Temperature

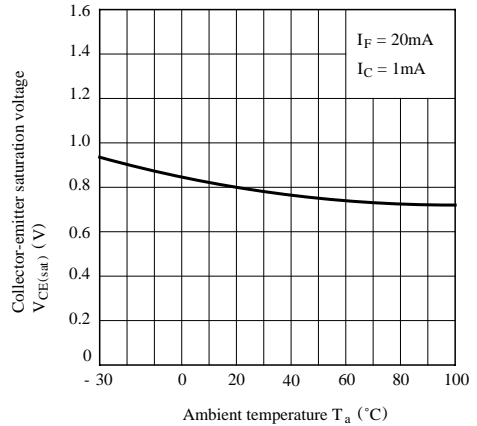

Fig.11 Collector Dark Current vs. Ambient Temperature

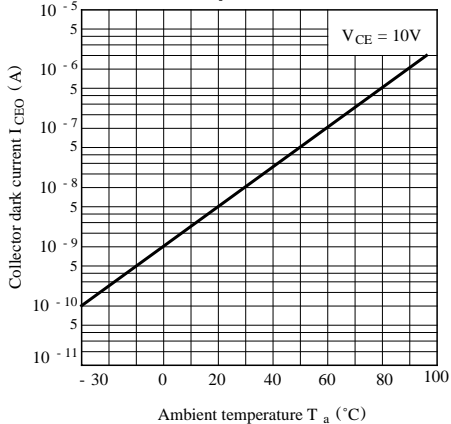
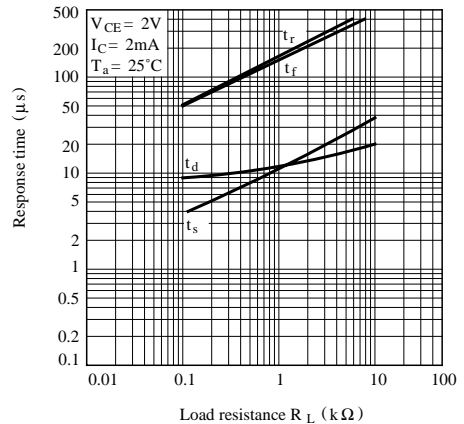

Fig.12 Responce Time vs. Load Resistance



Test Circuit For Response Time

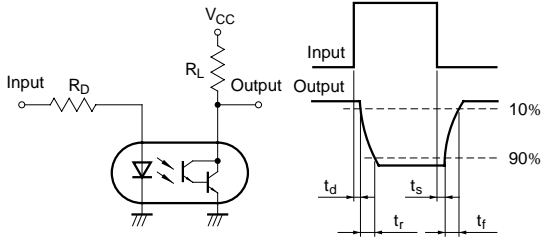
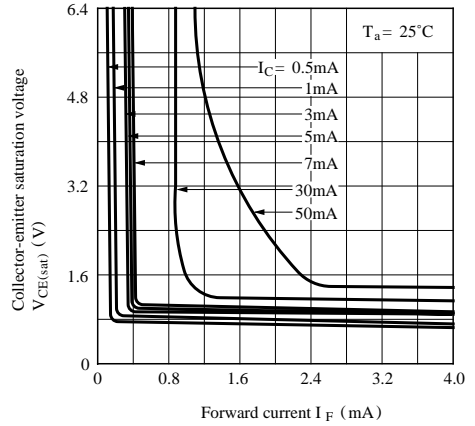
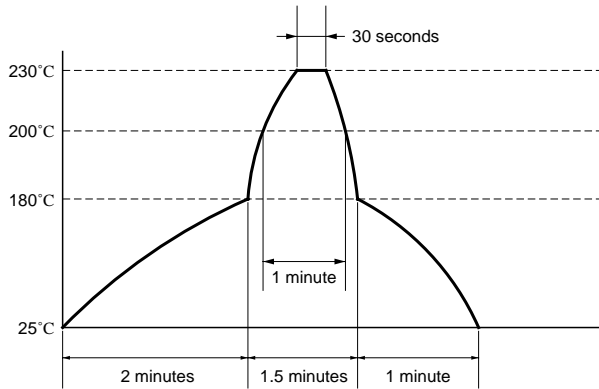

Fig.13 Collector-emitter Saturation Voltage vs. Forward Current



Temperature Profile of Soldering Reflow

(1) One time soldering reflow is recommended within the condition of temperature and time profile shown below.



(2) When using another soldering method such as infrared ray lamp, the temperature may rise partially in the mold of the device.

Keep the temperature on the package of the device within the condition of above (1).

● Please refer to the chapter “Precautions for Use.”