

## Compact, Slim Relays Conforming to EN Standards



- Relays with forcibly guided contacts (EN50205 Class A, certified by VDE).
- Supports the CE marking of machinery (Machinery Directive).
- Helps avoid hazardous machine status when used as part of an interlocking circuit.
- Four-pole and six-pole Relays are available.
- The Relay's terminal arrangement simplifies PWB pattern design.
- Reinforced insulation between inputs and outputs. Reinforced insulation between some poles of different polarity.



For the most recent information on models that have been certified for safety standards, refer to your OMRON website.

Be sure to read the "Safety Precautions" on page 6 and the "Precautions for All Relays with Forcibly Guided Contacts".

## Model Number Structure

### Model Number Legend

G7SA- A B

1      2

**1. NO Contact Poles**

- 2: DPST-NO
- 3: 3PST-NO
- 4: 4PST-NO
- 5: 5PST-NO

**2. NC Contact Poles**

- 1: SPST-NC
- 2: DPST-NC
- 3: 3PST-NC

## Ordering Information

### Relays with Forcibly Guided Contacts

Type	Sealing	Poles	Contact configuration	Rated voltage	Model
Standard	Flux-tight	4 poles	3PST-NO, SPST-NC	12 VDC 18 VDC 21 VDC 24 VDC 48 VDC	G7SA-3A1B
			DPST-NO, DPST-NC		G7SA-2A2B
		6 poles	5PST-NO, SPST-NC		G7SA-5A1B
			4PST-NO, DPST-NC		G7SA-4A2B
			3PST-NO, 3PST-NC		G7SA-3A3B

### Sockets

Type	LED indicator	Poles	Rated voltage	Model
Track-mounting	No	4 poles	---	P7SA-10F
		6 poles		P7SA-14F
	Yes	4 poles	24 VDC	P7SA-10F-ND
		6 poles		P7SA-14F-ND
Back-mounting	No	4 poles	---	P7SA-10P
		6 poles		P7SA-14P

## Specifications

### Ratings

#### Coil (4 poles)

Item	Rated current (mA)	Coil resistance ( $\Omega$ )	Max. voltage (V)	Power consumption (mW)
Rated voltage				
12 VDC	30	400	110%	Approx. 360
18 VDC	20	900		
21 VDC	17.1	1,225		
24 VDC	15	1,600		
48 VDC	7.5	6,400		

#### Coil (6 poles)

Item	Rated current (mA)	Coil resistance ( $\Omega$ )	Max. voltage (V)	Power consumption (mW)
Rated voltage				
12 VDC	41.7	288	110%	Approx. 500
18 VDC	27.8	648		
21 VDC	23.8	882		
24 VDC	20.8	1,152		
48 VDC	10.4	4,606		

- Note:** 1. The rated current and coil resistance are measured at a coil temperature of 23°C with tolerances of  $\pm 15\%$ .  
2. The maximum voltage is based on an ambient operating temperature of 23°C maximum.

### Contacts

Item	Load	Resistive load
Rated load		6 A at 250 VAC, 6 A at 30 VDC
Rated carry current		6 A
Max. switching voltage		250 VAC, 125 VDC
Max. switching current		6 A

### Characteristics of Sockets

Model	P7SA-10F P7SA-10F-ND	P7SA-14F P7SA-14F-ND	P7SA-10P	P7SA-14P
Continuous current	6 A *1			
Dielectric strength	2,500 VAC for 1 min. between poles			
Insulation resistance	1,000 M $\Omega$ min. *2			
Weight	Approx. 44 g	Approx. 59 g	Approx. 9 g	Approx. 10 g

- Note:** Use the P7SA-1□F-ND in the ambient temperature range of  $-20$  to  $70^\circ\text{C}$ .  
Use the P7SA-1□F and P7SA-1□F-ND in the ambient humidity range of 45 to 85%.
- \*1. When operating the P7SA-1□F at a temperature between  $55$  and  $85^\circ\text{C}$ , reduce the continuous current (6 A at  $55^\circ\text{C}$  or less) by 0.1 A for each degree above  $55^\circ\text{C}$ .  
When operating the P7SA-1□F-ND at a temperature between  $50$  and  $70^\circ\text{C}$ , reduce the continuous current (6 A at  $50^\circ\text{C}$  or less) by 0.3 A for each degree above  $50^\circ\text{C}$ .
- \*2. Measurement conditions: Measurement of the same points as for the dielectric strength at 500 VDC.

### Characteristics

Contact resistance *1	100 m $\Omega$ max.	
Operating time *2	20 ms max.	
Response time *3	10 ms max.	
Release time *2	20 ms max.	
Must operate voltage	75% max.	
Must release voltage	10% min.	
Maximum operating frequency	Mechanical	36,000 operations/h
	Rated load	1,800 operations/h
Insulation resistance *4	1,000 M $\Omega$ min.	
Dielectric strength *5 *6	Between coil contacts/different poles (except for poles 3-4 in 4-pole Relays and poles 3-5, 4-6, and 5-6 in 6-pole Relays):	4,000 VAC, 50/60 Hz for 1 min.
	Between different poles (poles 3-4 in 4-pole Relays and poles 3-5, 4-6, and 5-6 in 6-pole Relays):	2,500 VAC, 50/60 Hz for 1 min.
	Between contacts of same polarity:	1,500 VAC, 50/60 Hz for 1 min.
Vibration resistance	10 to 55 to 10 Hz, 0.75-mm single amplitude (1.5-mm double amplitude)	
Shock resistance	Destruction	1,000 m/s <sup>2</sup>
	Malfunction	100 m/s <sup>2</sup>
Durability *7	Mechanical	10,000,000 operations min. (at approx. 36,000 operations/h)
	Electrical	100,000 operations min. (at the rated load and approx. 1,800 operations/h)
Inductive load switching capability *8 (IEC60947-5-1)	AC15 AC240V 2A DC13 DC24V 1A	
Failure rate (P level) (reference value *9)	5 VDC, 1 mA	
Ambient operating temperature *10	12 to 48 VDC: $-40$ to $85^\circ\text{C}$ (with no icing or condensation)	
Ambient operating humidity	5% to 85%	
Weight	4 poles: Approx. 22 g	
	6 poles: Approx. 25 g	

- Note:** 1. The above values are initial values.  
2. Performance characteristics are based on coil temperature of  $23^\circ\text{C}$ .
- \*1. The contact resistance was measured with 1 A at 5 VDC using the voltage-drop method.  
\*2. These times were measured at the rated voltage and an ambient temperature of  $23^\circ\text{C}$ . Contact bounce time is not included.  
\*3. The response time is the time it takes for the normally open contacts to open after the coil voltage is turned OFF. Contact bounce time is included. Measurement conditions: Rated voltage operation, Ambient temperature:  $23^\circ\text{C}$   
\*4. The insulation resistance was measured with a 500-VDC megohmmeter at the same locations as the dielectric strength was measured.  
\*5. Pole 3 refers to terminals 31-32 or 33-34, pole 4 refers to terminals 43-44, pole 5 refers to terminals 53-54, and pole 6 refers to terminals 63-64.  
\*6. When using a P7SA Socket, the dielectric strength between coil contacts/different poles is 2,500 VAC, 50/60 Hz for 1 min.  
\*7. The durability is for an ambient temperature of 15 to  $35^\circ\text{C}$  and an ambient humidity of 25% to 75%. For the durability performance to the load, refer to the Durability Curve.  
\*8. AC15:  $\cos\phi = 0.3$ , DC13: L/R = 48-ms.  
\*9. The failure rate is based on an operating frequency of 300 operations/min.  
\*10. 12 to 48 VDC:  
When operating between  $70$  and  $85^\circ\text{C}$ , reduce the rated carry current of 6 A by 0.1 A for each degree above  $70^\circ\text{C}$ .

# Engineering Data

## Durability Curve

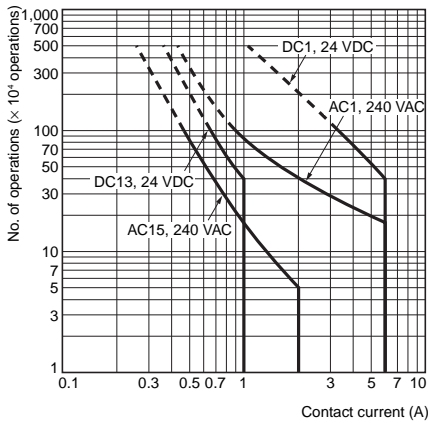

## Dimensions

(Unit: mm)

### Relays with Forcibly Guided Contacts

G7SA-3A1B  
G7SA-2A2B

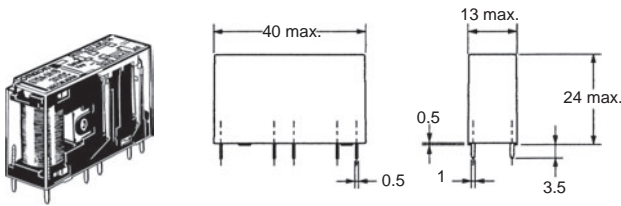

Terminal Arrangement/  
Internal Connection Diagram  
(Bottom View)

G7SA-3A1B

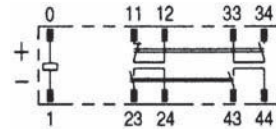

G7SA-2A2B

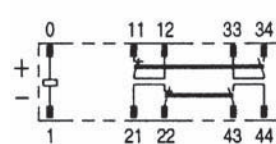

Printed Circuit Board  
Design Diagram  
(Bottom View)

(±0.1 tolerance)

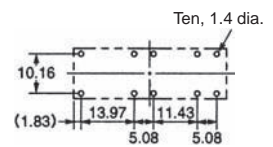

- Note: 1.** Terminals 23-24, 33-34, and 43-44 are normally open. Terminals 11-12 and 21-22 are normally closed.
- 2.** The colors of the cards inside the Relays are as follows: G7SA-3A1B: Blue and G7SA-2A2B: White.

G7SA-5A1B  
G7SA-4A2B  
G7SA-3A3B



Terminal Arrangement/  
Internal Connection Diagram  
(Bottom View)

G7SA-5A1B

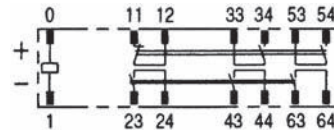

G7SA-4A2B

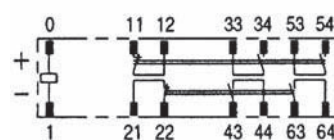

G7SA-3A3B

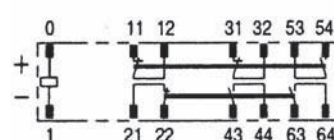

Printed Circuit Board  
Design Diagram  
(Bottom View)

(±0.1 tolerance)

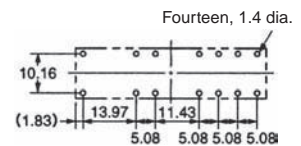

- Note: 1.** Terminals 23-24, 33-34, 43-44, 53-54, and 63-64 are normally open. Terminals 11-12, 21-22, and 31-32 are normally closed.
- 2.** The colors of the cards inside the Relays are as follows: G7SA-5A1B: Blue, G7SA-4A2B: White, and G7SA-3A3B: Yellow.

Sockets

Track-mounting Socket  
P7SA-10F, P7SA-10F-ND

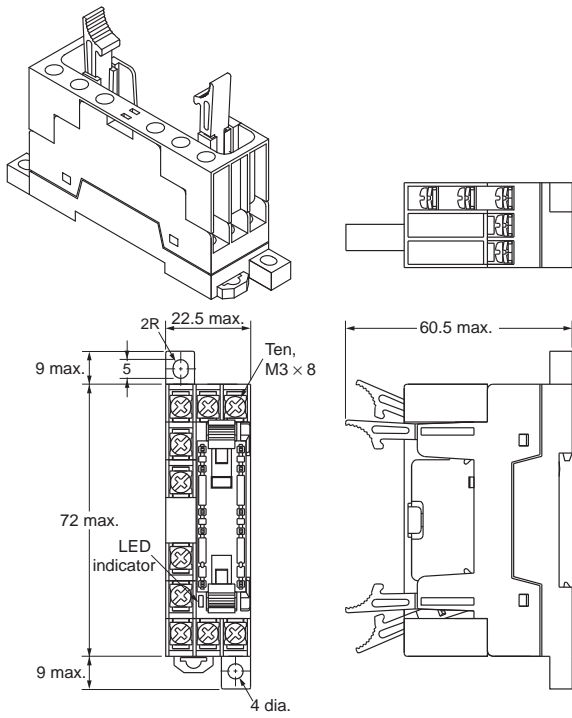

Note 1: The socket is shown with the finger cover removed.  
2: Only the -ND Sockets have LED indicators (orange)

Terminal Arrangement/Internal Connection Diagram  
(Top View)

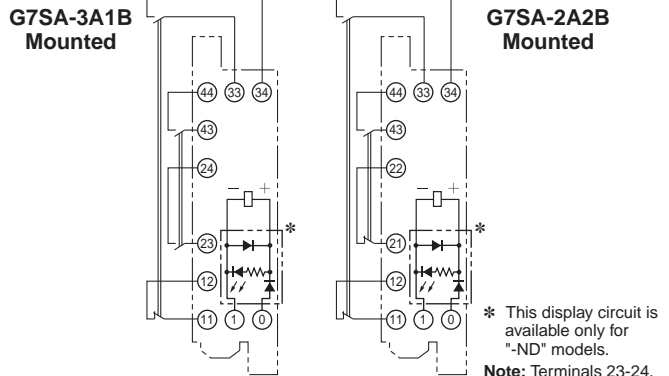

\* This display circuit is available only for "-ND" models.  
Note: Terminals 23-24, 33-34, and 43-44 are normally open. Terminals 11-12 and 21-22 are normally closed.

Mounting Hole Placement Diagram  
(Top View)

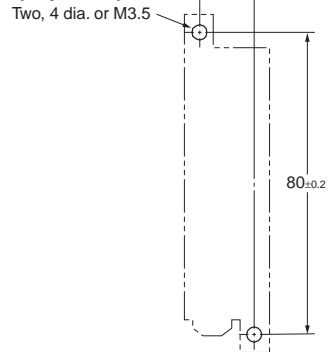

Track-mounting Socket  
P7SA-14F, P7SA-14F-ND

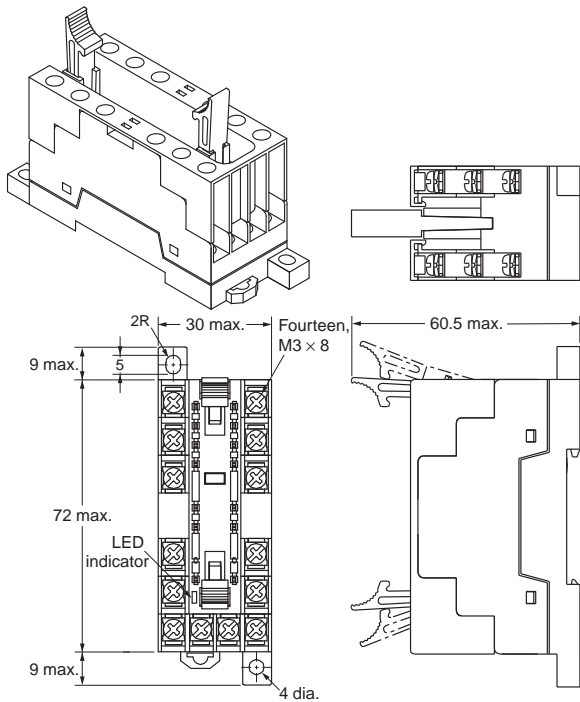

Note 1: The socket is shown with the finger cover removed.  
2: Only the -ND Sockets have LED indicators (orange).

Terminal Arrangement/Internal Connection Diagram  
(Top View)

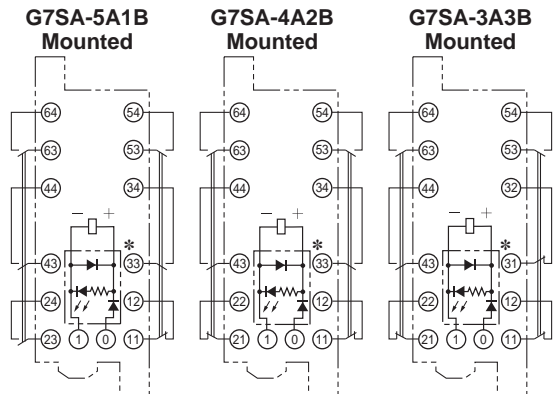

\* This display circuit is available only for "-ND" models.  
Note: Terminals 23-24, 33-34, 43-44, 53-54, and 63-64 are normally open. Terminals 11-12, 21-22, and 31-32 are normally closed.

Mounting Hole Placement Diagram  
(Top View)

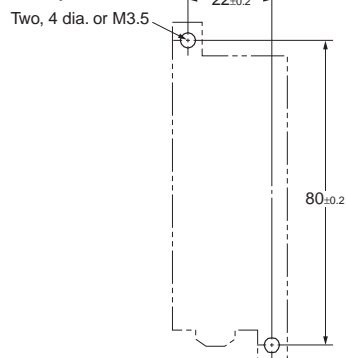

## Back-mounting Socket (for PCB) P7SA-10P

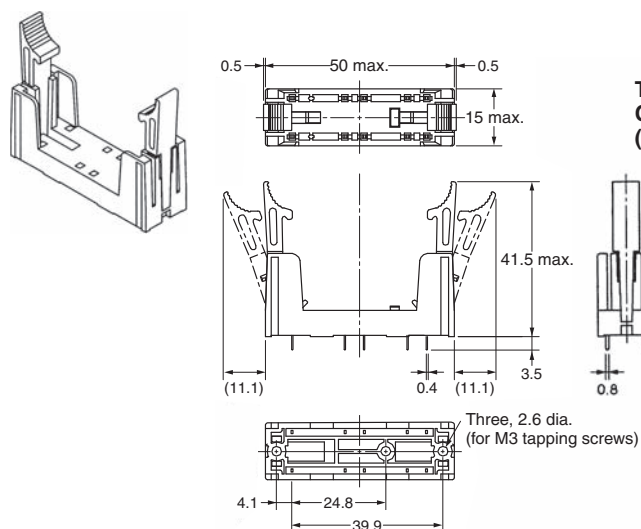

### Terminal Arrangement/Internal Connection Diagram (Bottom View)

#### G7SA-3A1B Mounted

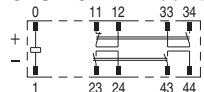

#### G7SA-2A2B Mounted

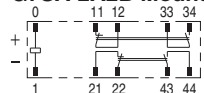

### Mounting Hole Placement (Bottom View)

(±0.1 tolerance)

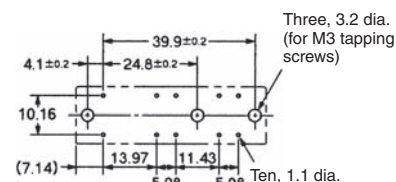

**Note:** Terminals 23-24, 33-34, and 43-44 are normally open. Terminals 11-12 and 21-22 are normally closed.

## Back-mounting Socket (for PCB) P7SA-14P

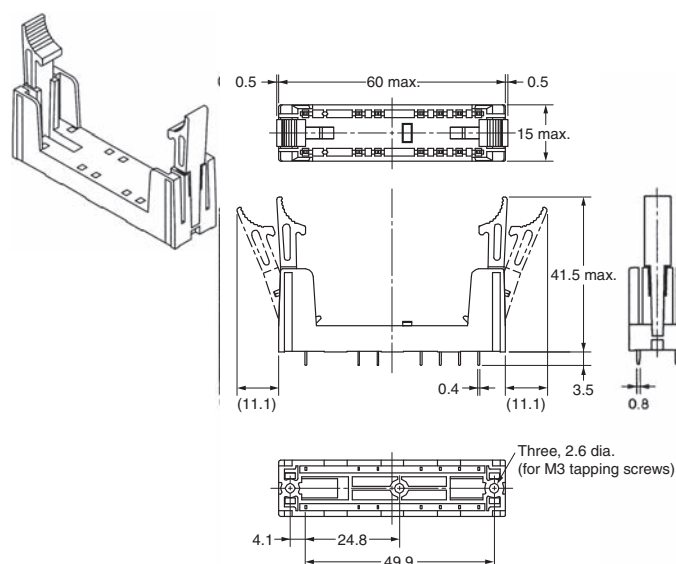

### Terminal Arrangement/Internal Connection Diagram (Bottom View)

#### G7SA-5A1B Mounted

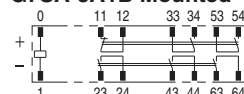

#### G7SA-4A2B Mounted



#### G7SA-3A3B Mounted

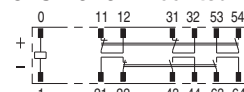

### Mounting Hole Placement (Bottom View)

(±0.1 tolerance)

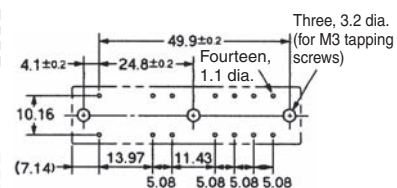

**Note:** Terminals 23-24, 33-34, 43-44, 53-54, and 63-64 are normally open. Terminals 11-12, 21-22, and 31-32 are normally closed.

## Certified Standards

### G7SA

- EN Standards, VDE Certified
  - EN61810-1 (Electromechanical non-specified time all-or-nothing relays)
  - EN50205 (Relays with forcibly guided (linked) contacts)
- UL standard UL508 Industrial Control Devices
- CSA standard CSA C22.2 No. 14 Industrial Control Devices
- South Korea S-mark certified (Rated voltage 24VDC only)
  - KS C IEC 61810-1
  - EN 50205

### P7SA

- UL standard UL508 Industrial Control Devices
- CSA standard CSA C22.2 No. 14 Industrial Control Devices

## Forcibly Guided Contacts (from EN50205)

If an NO contact becomes welded, all NC contacts will maintain a minimum distance of 0.5 mm when the coil is not energized. Likewise if an NC contact becomes welded, all NO contacts will maintain a minimum distance of 0.5 mm when the coil is energized.

## Safety Precautions

Be sure to read the precautions for “*Precautions for All Relays*” and “*Precautions for All Relays with Forcibly Guided Contacts*” in the website at:<http://www.ia.omron.com/>.

### Precautions for Correct Use

**Supplementary comments on what to do or avoid doing, to prevent failure to operate, malfunction or undesirable effect on product performance.**

#### Wiring

- Use one of the following wires to connect to the P7SA-10F/10F-ND/14F/14F-ND.  
Stranded wire: 0.75 to 1.5 mm<sup>2</sup>  
Solid wire: 1.0 to 1.5 mm<sup>2</sup>
- Tighten each screw of the P7SA-10F/10F-ND/14F/14F-ND to a torque of 0.78 to 0.98 N·m.
- Wire the terminals correctly with no mistakes in coil polarity, otherwise the G7SA will not operate.
- If you use the P7SA-□F-ND, the release time and the response time of the G7SA will be longer because the P7SA-□F-ND has a built-in diode to absorb coil surge. Confirm operation under actual conditions before you use the P7SA-□F-ND.

#### Cleaning

The G7SA is not of enclosed construction. Therefore, do not wash the G7SA with water or detergent.

#### Mounting

The G7S can be installed in any direction.

#### Direction for Inserting and Removing the Relay

When you insert the Relay into the Socket or remove the Relay from the Socket, keep the Relay perpendicular to the surface of the Socket.

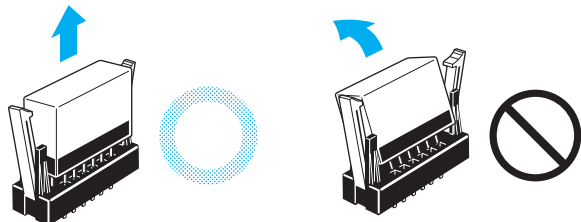

If you hold the Relay at an angle when you insert or remove it, the Relay pins may be bent and Socket contact failure may occur.



## Terms and Conditions Agreement

### Read and understand this catalog.

Please read and understand this catalog before purchasing the products. Please consult your OMRON representative if you have any questions or comments.

### Warranties.

(a) Exclusive Warranty. Omron's exclusive warranty is that the Products will be free from defects in materials and workmanship for a period of twelve months from the date of sale by Omron (or such other period expressed in writing by Omron). Omron disclaims all other warranties, express or implied.

(b) Limitations. OMRON MAKES NO WARRANTY OR REPRESENTATION, EXPRESS OR IMPLIED, ABOUT NON-INFRINGEMENT, MERCHANTABILITY OR FITNESS FOR A PARTICULAR PURPOSE OF THE PRODUCTS. BUYER ACKNOWLEDGES THAT IT ALONE HAS DETERMINED THAT THE PRODUCTS WILL SUITABLY MEET THE REQUIREMENTS OF THEIR INTENDED USE.

Omron further disclaims all warranties and responsibility of any type for claims or expenses based on infringement by the Products or otherwise of any intellectual property right. (c) Buyer Remedy. Omron's sole obligation hereunder shall be, at Omron's election, to (i) replace (in the form originally shipped with Buyer responsible for labor charges for removal or replacement thereof) the non-complying Product, (ii) repair the non-complying Product, or (iii) repay or credit Buyer an amount equal to the purchase price of the non-complying Product; provided that in no event shall Omron be responsible for warranty, repair, indemnity or any other claims or expenses regarding the Products unless Omron's analysis confirms that the Products were properly handled, stored, installed and maintained and not subject to contamination, abuse, misuse or inappropriate modification. Return of any Products by Buyer must be approved in writing by Omron before shipment. Omron Companies shall not be liable for the suitability or unsuitability or the results from the use of Products in combination with any electrical or electronic components, circuits, system assemblies or any other materials or substances or environments. Any advice, recommendations or information given orally or in writing, are not to be construed as an amendment or addition to the above warranty.

See <http://www.omron.com/global/> or contact your Omron representative for published information.

### Limitation on Liability; Etc.

OMRON COMPANIES SHALL NOT BE LIABLE FOR SPECIAL, INDIRECT, INCIDENTAL, OR CONSEQUENTIAL DAMAGES, LOSS OF PROFITS OR PRODUCTION OR COMMERCIAL LOSS IN ANY WAY CONNECTED WITH THE PRODUCTS, WHETHER SUCH CLAIM IS BASED IN CONTRACT, WARRANTY, NEGLIGENCE OR STRICT LIABILITY.

Further, in no event shall liability of Omron Companies exceed the individual price of the Product on which liability is asserted.

### Suitability of Use.

Omron Companies shall not be responsible for conformity with any standards, codes or regulations which apply to the combination of the Product in the Buyer's application or use of the Product. At Buyer's request, Omron will provide applicable third party certification documents identifying ratings and limitations of use which apply to the Product. This information by itself is not sufficient for a complete determination of the suitability of the Product in combination with the end product, machine, system, or other application or use. Buyer shall be solely responsible for determining appropriateness of the particular Product with respect to Buyer's application, product or system. Buyer shall take application responsibility in all cases.

NEVER USE THE PRODUCT FOR AN APPLICATION INVOLVING SERIOUS RISK TO LIFE OR PROPERTY OR IN LARGE QUANTITIES WITHOUT ENSURING THAT THE SYSTEM AS A WHOLE HAS BEEN DESIGNED TO ADDRESS THE RISKS, AND THAT THE OMRON PRODUCT(S) IS PROPERLY RATED AND INSTALLED FOR THE INTENDED USE WITHIN THE OVERALL EQUIPMENT OR SYSTEM.

### Programmable Products.

Omron Companies shall not be responsible for the user's programming of a programmable Product, or any consequence thereof.

### Performance Data.

Data presented in Omron Company websites, catalogs and other materials is provided as a guide for the user in determining suitability and does not constitute a warranty. It may represent the result of Omron's test conditions, and the user must correlate it to actual application requirements. Actual performance is subject to the Omron's Warranty and Limitations of Liability.

### Change in Specifications.

Product specifications and accessories may be changed at any time based on improvements and other reasons. It is our practice to change part numbers when published ratings or features are changed, or when significant construction changes are made. However, some specifications of the Product may be changed without any notice. When in doubt, special part numbers may be assigned to fix or establish key specifications for your application. Please consult with your Omron's representative at any time to confirm actual specifications of purchased Product.

### Errors and Omissions.

Information presented by Omron Companies has been checked and is believed to be accurate; however, no responsibility is assumed for clerical, typographical or proofreading errors or omissions.

2014.1

In the interest of product improvement, specifications are subject to change without notice.

**OMRON Corporation**  
Industrial Automation Company

<http://www.ia.omron.com/>

(c)Copyright OMRON Corporation 2014 All Right Reserved.