

Extrusion designed for 60mm wide x 80mm long PCBs.

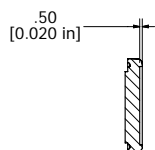

SECTION A-A

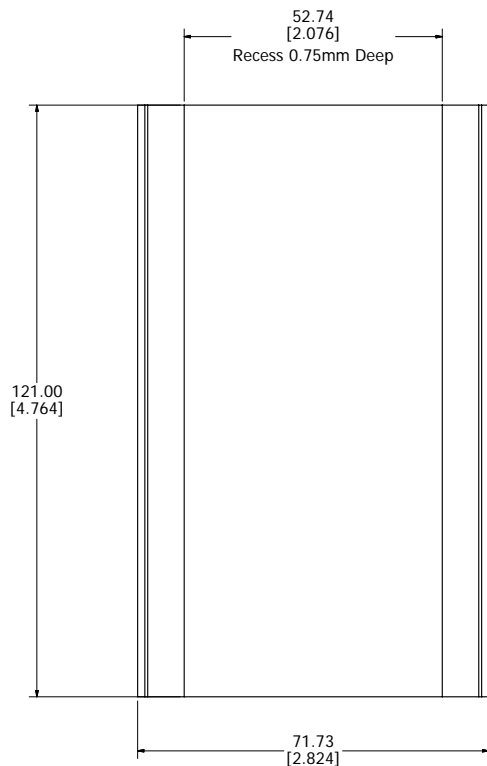
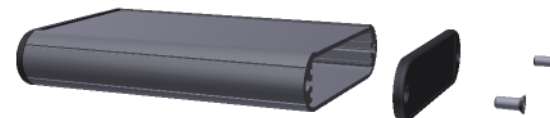
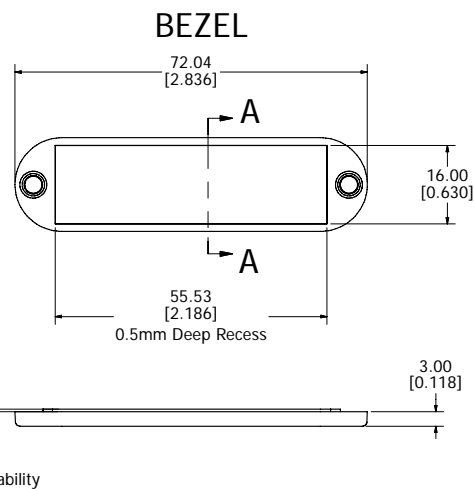

Enclosures can be Factory Modified (Milling, Drilling, Printing etc.)
Solid models of this enclosure available in STEP or IGES.
Contact Factory mjm@hammondmfg.com

NOTE	
Purchased assembly includes box, plastic bezels, #6 Taptight screws and self adhesive rubber feet.	
Box made from Extruded Aluminum 6063.	
Bezels made from polycarbonate.	

1455B1202	
PART NUMBERS	
Clear Anodized	1455B1202
Black Anodized	1455B1202BK
ACCESSORIES	
See website for accessories.	

HAMMOND MANUFACTURING™
1455B1202
www.hammondmfg.com