

THIS DOCUMENT IS THE PROPERTY OF KEYSTONE ELECTRONICS CORP. AND SHALL NOT BE REPRODUCED, DISTRIBUTED OR USED AS A BASIS FOR MANUFACTURE WITHOUT PRIOR WRITTEN PERMISSION FROM KEYSTONE ELECTRONICS CORP.

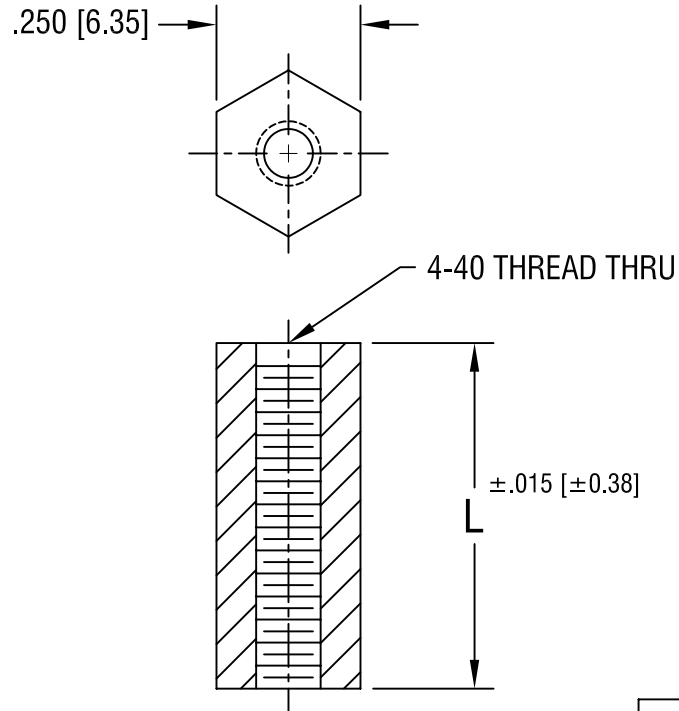

PART NO.	'L' DIM.
8440A	.250 [6.35]
8440B	.375 [9.52]
8440C	.500 [12.70]
8440D	.625 [15.87]
8440E	.750 [19.05]
8440F	.875 [22.22]
8440G	1.000 [25.4]

KEYSTONE ELECTRONICS CORP.			
ASTORIA, N.Y. 11105-2017			
PART NAME			
HEX STANDOFF, FLAME RETARDANT			
MATERIAL			
NYLON 6/6 UL 94V-0			
FINISH		DRN BY	DATE
-		BOONE	1.25.96
		APPD	SCALE
			3X
TOLERANCES	INCH [MM]	CODE	DWG NO.
DECIMAL	$\pm .005$ [± 0.15]	C/M	8440-
ANGULAR	$\pm 1^\circ$		
UNLESS OTHERWISE SPECIFIED			

DATE	DESCRIPTION	REV.