

**Data sheet | Item number: 2091-1123**

1-conductor female plug; 1.5 mm<sup>2</sup>; Pin spacing 3.5 mm; 3-pole; 1,50 mm<sup>2</sup>;  
light gray

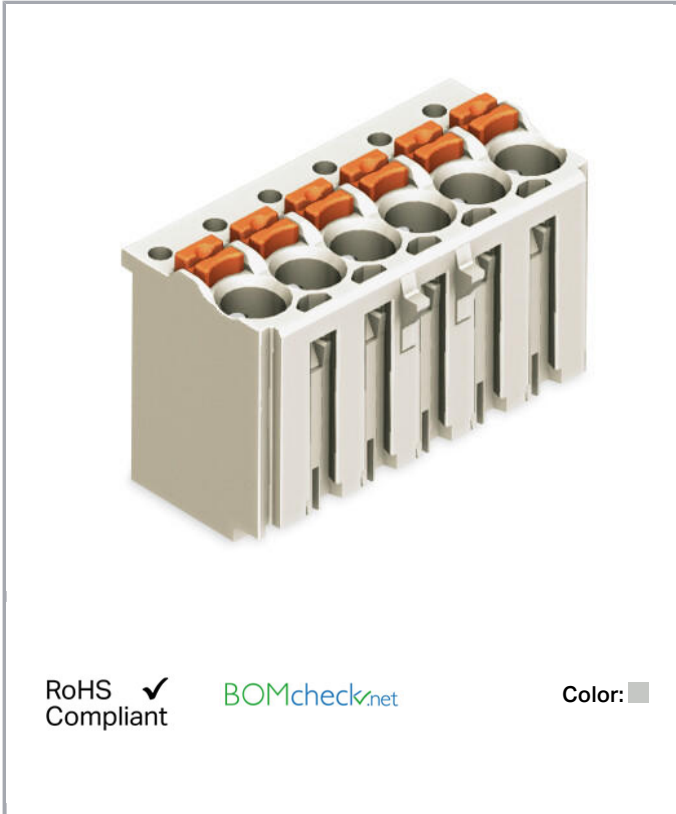

[www.wago.com/2091-1123](http://www.wago.com/2091-1123)



Subject to changes. Please also observe the further product documentation!

WAGO Kontakttechnik GmbH & Co. KG  
Hansastr. 27  
32423 Minden  
Phone: +49571 887-0 | Fax: +49571 887-169  
Email: [info.de@wago.com](mailto:info.de@wago.com) | Web: [www.wago.com](http://www.wago.com)

Do you have any questions about our products?  
We are always happy to take your call at +49 (571) 887-44222.

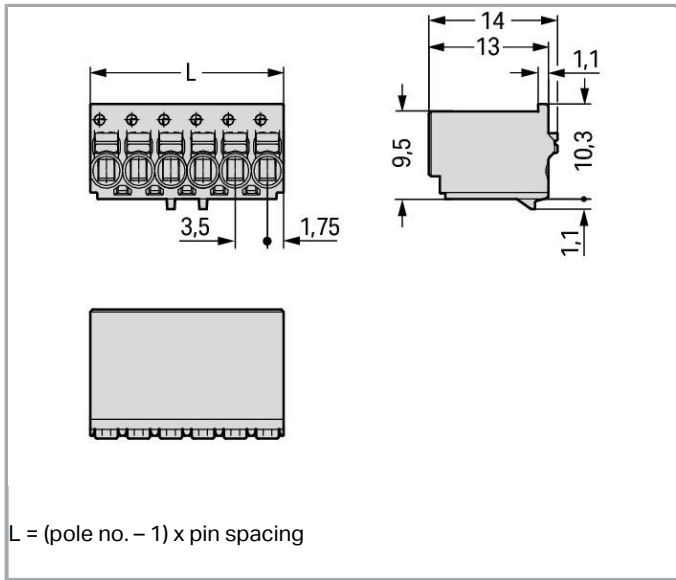

### Item description

- Universal connection of all conductor types
- Simple, push-in termination of solid and ferruled conductors
- Easy-to-use design does not require special tools
- Ability to wire while mated or unmated
- Testing parallel to conductor entry – tip contact
- Also available with gripping plates
- Integrated locking latches prevent accidental disconnection

### Safety information 1:

The **picoMAX® pluggable connection system** is designed without breaking capacity for compliance with DIN EN 61984. When used as intended, MCS Connectors shall not be connected/disconnected when live or under load. The circuit design should ensure header pins, which can be touched, are not live when unmated.

### Data

#### Electrical data

#### Ratings per IEC/EN 60664-1

Rated voltage (III / 3)	160 V
Rated impulse voltage (III / 3)	2.5 kV
Rated voltage (III / 2)	160 V
Rated impulse voltage (III / 2)	2.5 kV

Subject to changes. Please also observe the further product documentation!

WAGO Kontakttechnik GmbH & Co. KG  
 Hansastr. 27  
 32423 Minden  
 Phone: +49571 887-0 | Fax: +49571 887-169  
 Email: [info.de@wago.com](mailto:info.de@wago.com) | Web: [www.wago.com](http://www.wago.com)

Do you have any questions about our products?  
 We are always happy to take your call at +49 (571) 887-44222.



Rated voltage (II / 2)	320 V
Rated impulse voltage (II / 2)	2.5 kV
Rated current	10 A
Legend (ratings)	(III / 2) $\triangleq$ Overvoltage category III / Pollution degree 2

### Approvals per UL 1059

Rated voltage UL (Use Group B)	300 V
Rated current UL (Use Group B)	10 A
Rated voltage UL (Use Group D)	300 V
Rated current UL (Use Group D)	10 A
Approvals per	UL 1059

### Connection data

Connection technology	Push-in CAGE CLAMP <sup>®</sup>
Actuation type	Push-button
Solid conductor	0,2 ... 1,5 mm <sup>2</sup> / 24 ... 14 AWG
Fine-stranded conductor	0,2 ... 1,5 mm <sup>2</sup> / 24 ... 14 AWG
Fine-stranded conductor with ferrule with plastic collar	0,25 ... 0,75 mm <sup>2</sup>
Fine-stranded conductor with ferrule without plastic collar	0,25 ... 1,5 mm <sup>2</sup>
Strip length	8 ... 9 mm / 0.31 ... 0.35 inch
No. of poles	3
Total number of connection points	3
Total number of potentials	3
Number of connection types	1
Number of levels	1

### Geometrical Data

Pin spacing	3,5 mm / 0.138 inch
Width	10,5 mm / 0.413 inch
Height	14 mm / 0.551 inch
Depth	11,4 mm / 0.449 inch

### Plug connection

Contact type (pluggable connector)	Female connector/socket
Connector connection type	for conductors
Mismating protection	No

Subject to changes. Please also observe the further product documentation!

## Material Data

Color	light gray
Material group	I
Insulating material	Polyphthalamide (PPA GF)
Flammability class per UL94	V0
Clamping spring material	Chrome nickel spring steel (CrNi)
Contact material	Electrolytic copper (E <sub>Cu</sub> )
Contact plating	tin-plated
Fire load	0.034 MJ
Weight	1.4 g

## Environmental Requirements

Limit temperature range	-60 ... +100 °C
-------------------------	-----------------

## Commercial data

Product Group	26 (picoMAX)
Packaging type	BOX
Country of origin	DE
GTIN	4050821160762
Customs Tariff No.	85366990990

## Approvals / Certificates

### Country specific Approvals

Logo	Approval	Additional Approval Text	Certificate name
	<b>CB</b> DEKRA Certification B.V.	IEC 61984	NL-49736 /A1
	<b>CSA</b> DEKRA Certification B.V.	C22.2	2362521
	<b>KEMA/KEUR</b> DEKRA Certification B.V.	EN 61984	71-102260 REV.1









### UL-Approvals

Certificate

Subject to changes. Please also observe the further product documentation!

Logo	Approval	Additional Approval Text	name
	UL Underwriters Laboratories Inc.	UL 1977	20190909- E45171

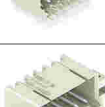
## Counterpart

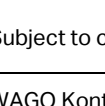

	<b>Item no.2091-1403</b> THT male header; 1.0 mm Ø solder pin; straight; Pin spacing 3.5 mm; 3-pole; light gray	<a href="http://www.wago.com/2091-1403">www.wago.com/2091-1403</a>
	<b>Item no.2091-1403/005-000</b> THT male header; 1.0 mm Ø solder pin; straight; clamping collar; Pin spacing 3.5 mm; 3-pole; light gray	<a href="http://www.wago.com/2091-1403/005-000">www.wago.com/2091-1403/005-000</a>
	<b>Item no.2091-1403/200-000</b> THR male header; 1.0 mm Ø solder pin; straight; Pin spacing 3.5 mm; 3-pole; light gray	<a href="http://www.wago.com/2091-1403/200-000">www.wago.com/2091-1403/200-000</a>
	<b>Item no.2091-1403/205-000</b> THR male header; 1.0 mm Ø solder pin; straight; clamping collar; Pin spacing 3.5 mm; 3-pole; light gray	<a href="http://www.wago.com/2091-1403/205-000">www.wago.com/2091-1403/205-000</a>
	<b>Item no.2091-1423</b> THT male header; 1.0 mm Ø solder pin; angled; Pin spacing 3.5 mm; 3-pole; light gray	<a href="http://www.wago.com/2091-1423">www.wago.com/2091-1423</a>
	<b>Item no.2091-1423/200-000/997-406</b> THR male header; 1.0 mm Ø solder pin; angled; in tape-and-reel packaging; Pin spacing 3.5 mm; 3-pole; light gray	<a href="http://www.wago.com/2091-1423/200-000/997-406">www.wago.com/2091-1423/200-000/997-406</a>
	<b>Item no.2091-1423/200-000</b> THR male header; 1.0 mm Ø solder pin; angled; Pin spacing 3.5 mm; 3-pole; light gray	<a href="http://www.wago.com/2091-1423/200-000">www.wago.com/2091-1423/200-000</a>
	<b>Item no.2091-1423/205-000</b> THR male header; 1.0 mm Ø solder pin; angled; clamping collar; Pin spacing 3.5 mm; 3-pole; light gray	<a href="http://www.wago.com/2091-1423/205-000">www.wago.com/2091-1423/205-000</a>
	<b>Item no.2091-1423/005-000</b> THT male header; 1.0 mm Ø solder pin; angled; clamping collar; Pin spacing 3.5 mm; 3-pole; light gray	<a href="http://www.wago.com/2091-1423/005-000">www.wago.com/2091-1423/005-000</a>
	<b>Item no.2091-1503/002-000</b> 1-conductor male connector; Gripping plate; 1.5 mm <sup>2</sup> ; Pin spacing 3.5 mm; 3-pole; 1,50 mm <sup>2</sup> ; light gray	<a href="http://www.wago.com/2091-1503/002-000">www.wago.com/2091-1503/002-000</a>

Subject to changes. Please also observe the further product documentation!

	<b>Item no.2091-1503/002-3000</b> 1-conductor male connector; Gripping plate; direct marking; 1.5 mm <sup>2</sup> ; Pin spacing 3.5 mm; 3-pole; 1,50 mm <sup>2</sup> ; light gray	<a href="http://www.wago.com/2091-1503/002-3000">www.wago.com/2091-1503/002-3000</a>
	<b>Item no.2091-1523/002-000</b> 1-conductor male connector; Integrated release lever; 1.5 mm <sup>2</sup> ; Pin spacing 3.5 mm; 3-pole; 1,50 mm <sup>2</sup> ; light gray	<a href="http://www.wago.com/2091-1523/002-000">www.wago.com/2091-1523/002-000</a>
	<b>Item no.2091-1523/002-3000</b> 1-conductor male connector; Integrated release lever; direct marking; 1.5 mm <sup>2</sup> ; Pin spacing 3.5 mm; 3-pole; 1,50 mm <sup>2</sup> ; light gray	<a href="http://www.wago.com/2091-1523/002-3000">www.wago.com/2091-1523/002-3000</a>
	<b>Item no.2091-1523/020-3000</b> 1-conductor male connector; Snap-in mounting feet; Integrated release lever; direct marking; 1.5 mm <sup>2</sup> ; Pin spacing 3.5 mm; 3-pole; 1,50 mm <sup>2</sup> ; light gray	<a href="http://www.wago.com/2091-1523/020-3000">www.wago.com/2091-1523/020-3000</a>
	<b>Item no.2091-1524/020-000</b> 1-conductor male connector; Snap-in mounting feet; Integrated release lever; 1.5 mm <sup>2</sup> ; Pin spacing 3.5 mm; 4-pole; 1,50 mm <sup>2</sup> ; light gray	<a href="http://www.wago.com/2091-1524/020-000">www.wago.com/2091-1524/020-000</a>
	<b>Item no.2091-1703</b> Solder pin strip; 1.0 mm Ø solder pin; straight; Pin spacing 3.5 mm; 3-pole; black	<a href="http://www.wago.com/2091-1703">www.wago.com/2091-1703</a>
	<b>Item no.2091-1703/200-000</b> Solder pin strip; 1.0 mm Ø solder pin; straight; Pin spacing 3.5 mm; 3-pole; black	<a href="http://www.wago.com/2091-1703/200-000">www.wago.com/2091-1703/200-000</a>
	<b>Item no.2091-1723</b> Solder pin strip; 1.0 mm Ø solder pin; angled; Pin spacing 3.5 mm; 3-pole; black	<a href="http://www.wago.com/2091-1723">www.wago.com/2091-1723</a>
	<b>Item no.2091-1723/200-000</b> Solder pin strip; 1.0 mm Ø solder pin; angled; Pin spacing 3.5 mm; 3-pole; black	<a href="http://www.wago.com/2091-1723/200-000">www.wago.com/2091-1723/200-000</a>

## Compatible products

### tools

	<b>Item no.: 2092-1630</b> Unlocking tool; orange	<a href="http://www.wago.com/2092-1630">www.wago.com/2092-1630</a>
	<b>Item no.: 210-719</b> Operating tool; Blade: 2.5 x 0.4 mm; with a partially insulated shaft	<a href="http://www.wago.com/210-719">www.wago.com/210-719</a>

### Strain relief plate

	<b>Item no.: 2091-1601</b> Gripping plate; light gray	<a href="http://www.wago.com/2091-1601">www.wago.com/2091-1601</a>
--	--	--

Subject to changes. Please also observe the further product documentation!



Item no.: 2091-1601/002-000  
Gripping plate with sliding connector release; light gray

[www.wago.com/2091-1601/002-000](http://www.wago.com/2091-1601/002-000)

Coding



Item no.: 2091-1610  
Coding key carrier; suitable for 3.5 mm pin spacing; orange

[www.wago.com/2091-1610](http://www.wago.com/2091-1610)

check



Item no.: 735-500  
Test pin; 1 mm Ø; with solder connection for test wire

[www.wago.com/735-500](http://www.wago.com/735-500)

Downloads

Documentation

Additional Information

Technical explanations	3.4.2019	pdf 3.6 MB	Download
------------------------	----------	---------------	----------

CAD/CAE-Data

CAD data

2D/3D Models 2091-1123	URL	Download
------------------------	-----	----------

Installation Notes

Locking

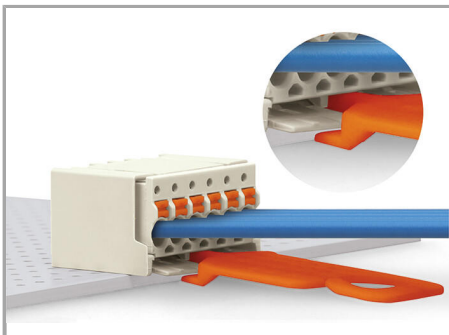

Disconnecting female connector via unlocking tool. Plug unlocking tool into the male header's locking latch.

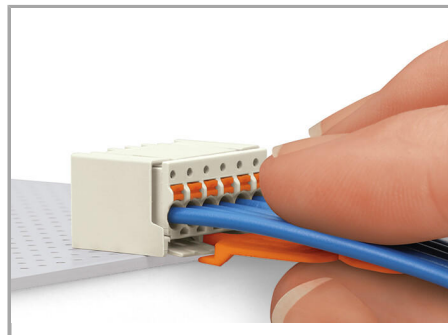

Insert unlocking tool until it hits backstop. Wedge opens locking latch.

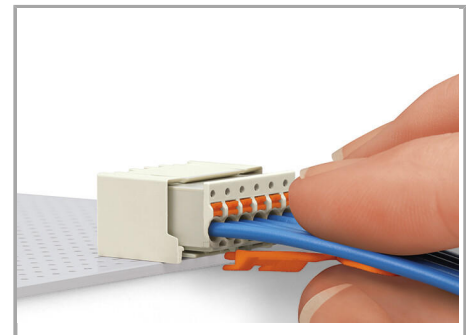

Pull on both unlocking tool and conductors to remove female connector from male header.

Inserting a conductor

Subject to changes. Please also observe the further product documentation!

WAGO Kontakttechnik GmbH & Co. KG  
Hansastr. 27  
32423 Minden  
Phone: +49571 887-0 | Fax: +49571 887-169  
Email: [info.de@wago.com](mailto:info.de@wago.com) | Web: [www.wago.com](http://www.wago.com)

Do you have any questions about our products?  
We are always happy to take your call at +49 (571) 887-44222.

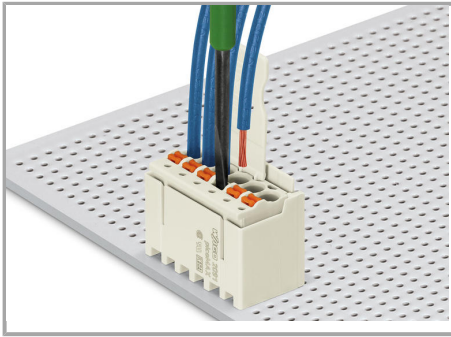

Inserting fine-stranded conductor into mated female connector via push-button.

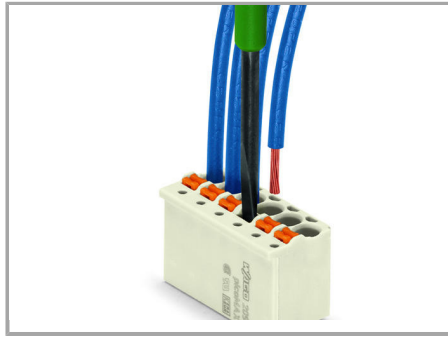

Inserting fine-stranded conductor into unmated female connector via push-button.

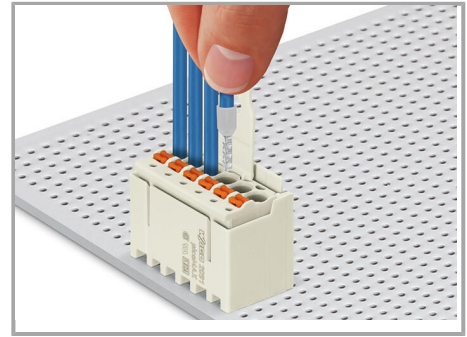

Inserting solid and ferruled conductors via push-in termination

### Marking



Pole marking via factory direct printing.

### Coding

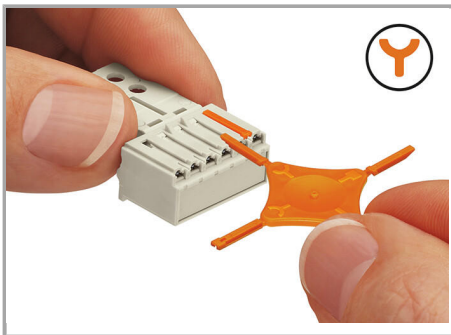

Coding a female connector (via coding key carrier and two keys for female connector, see symbol).

### Testing

Subject to changes. Please also observe the further product documentation!



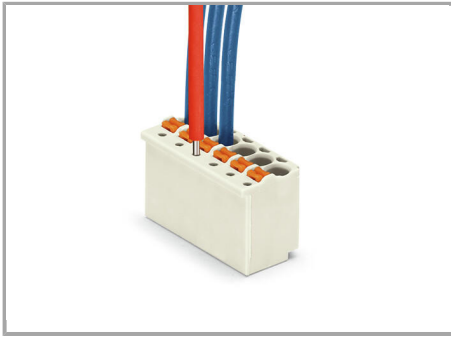

Testing with 1 mm Ø test pin, tip contact.

## Product family

**picoMAX**

[Show all products from the family](#)

Subject to changes. Please also observe the further product documentation!