

| | | |
|----------------|------|----------------------------|
| Model produktu | Z-44 | |
| Format: | A4 | Materiał: Polystyrene (PS) |
| Skala: | 1:1 | Tolerancja: +/- 0.1 |

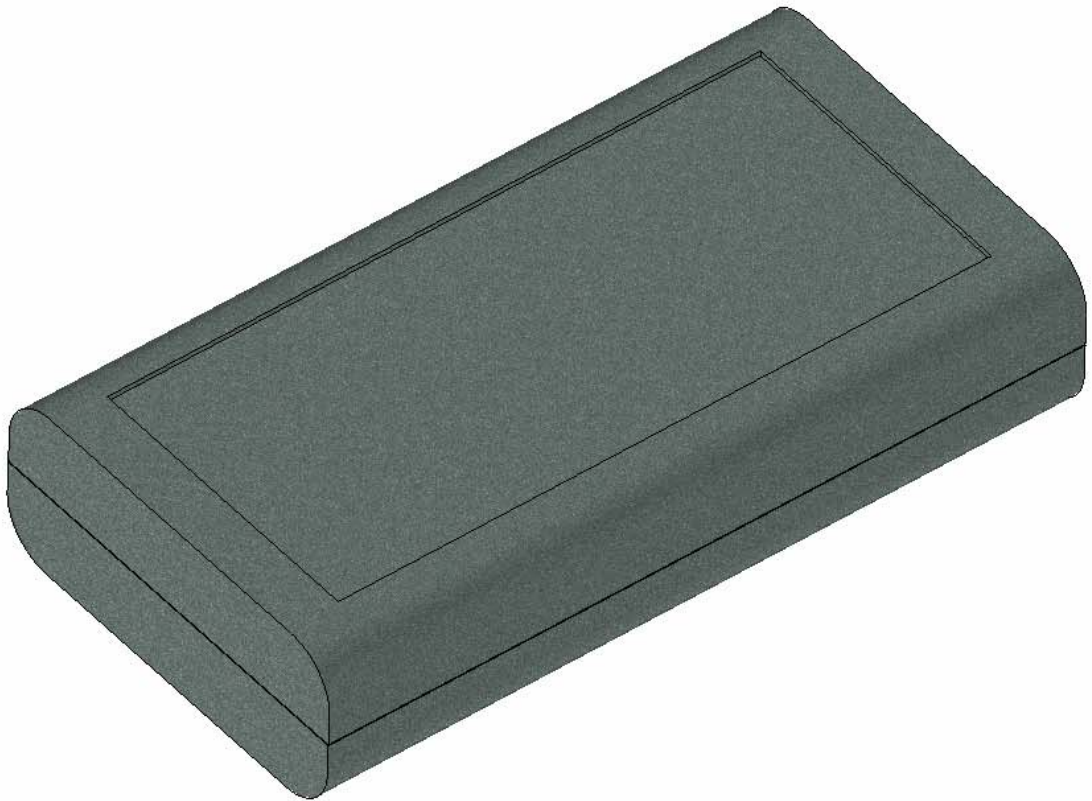

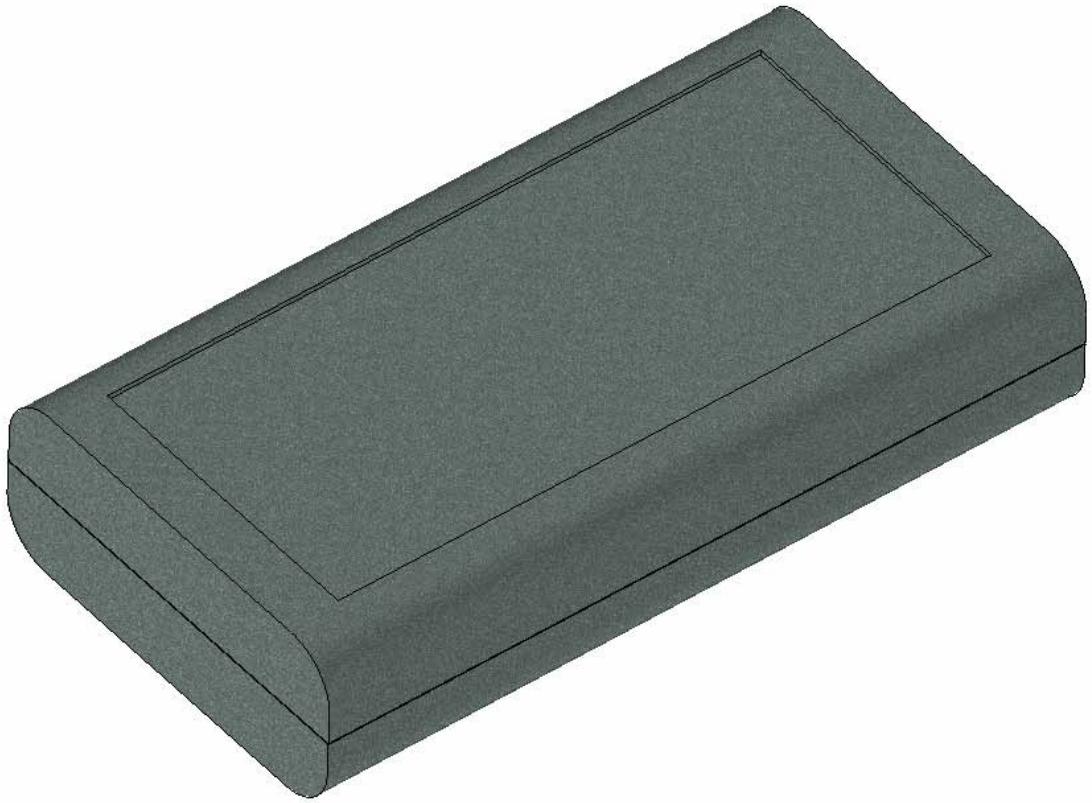

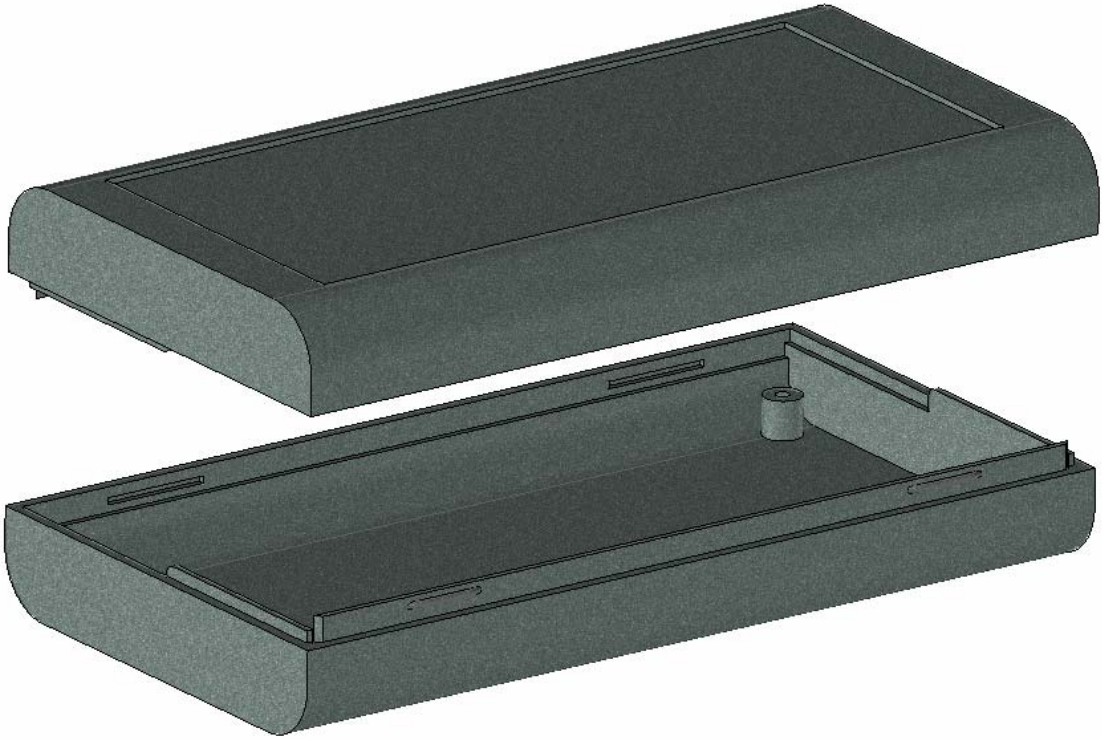

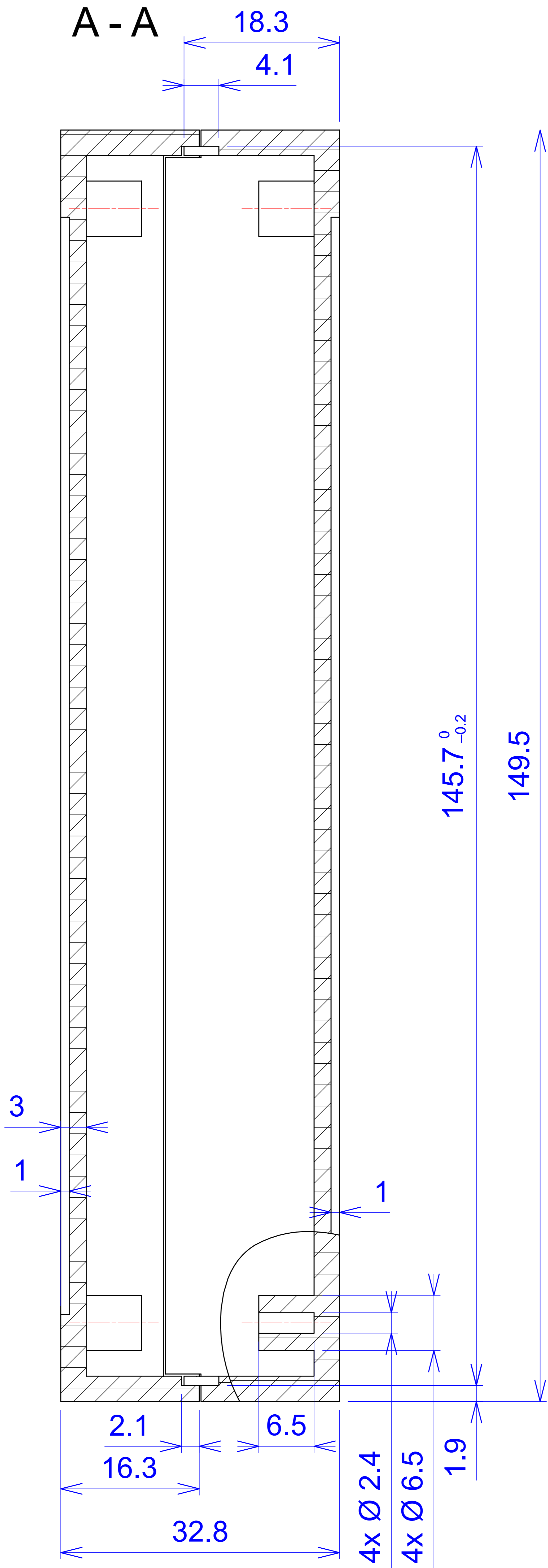

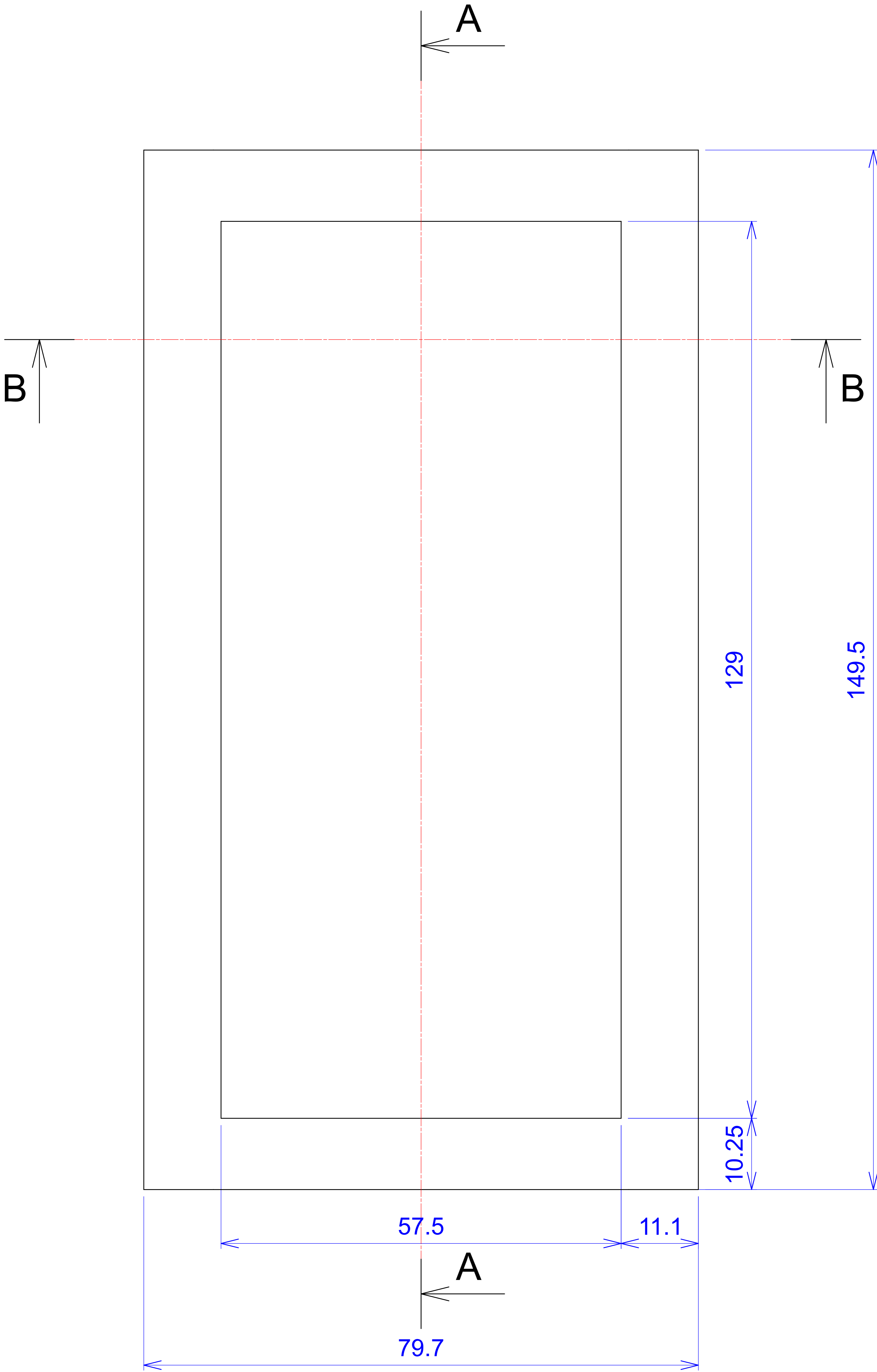

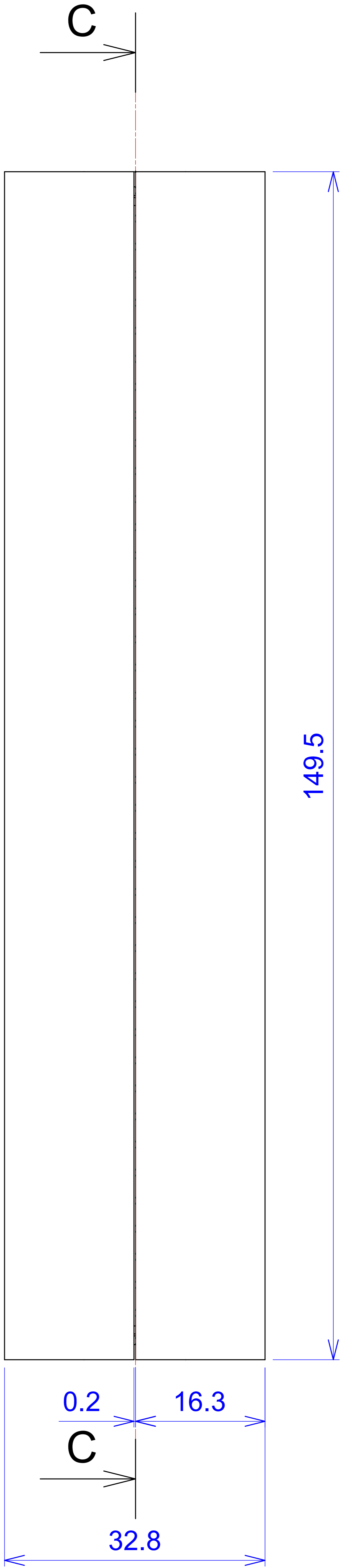

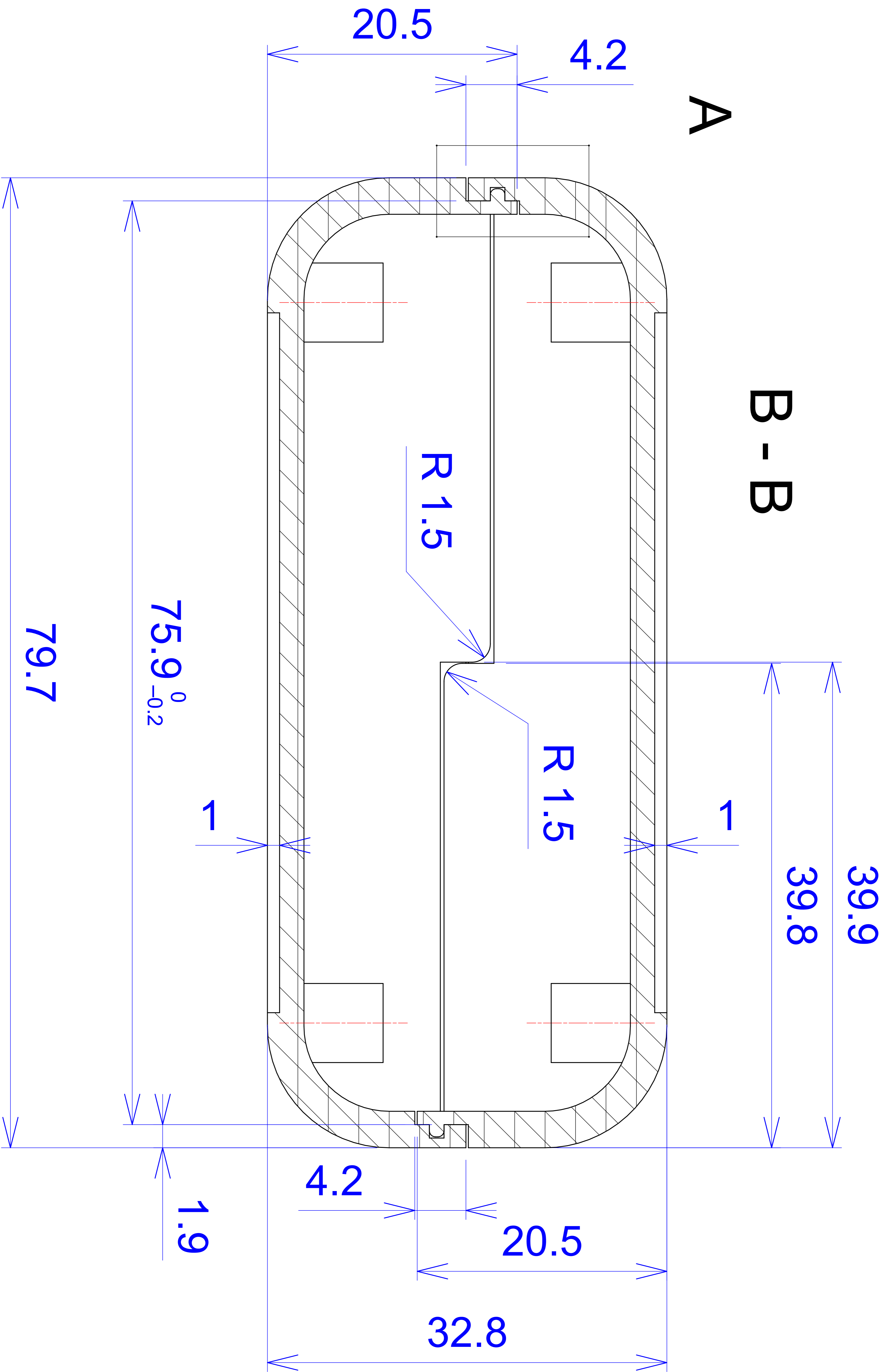

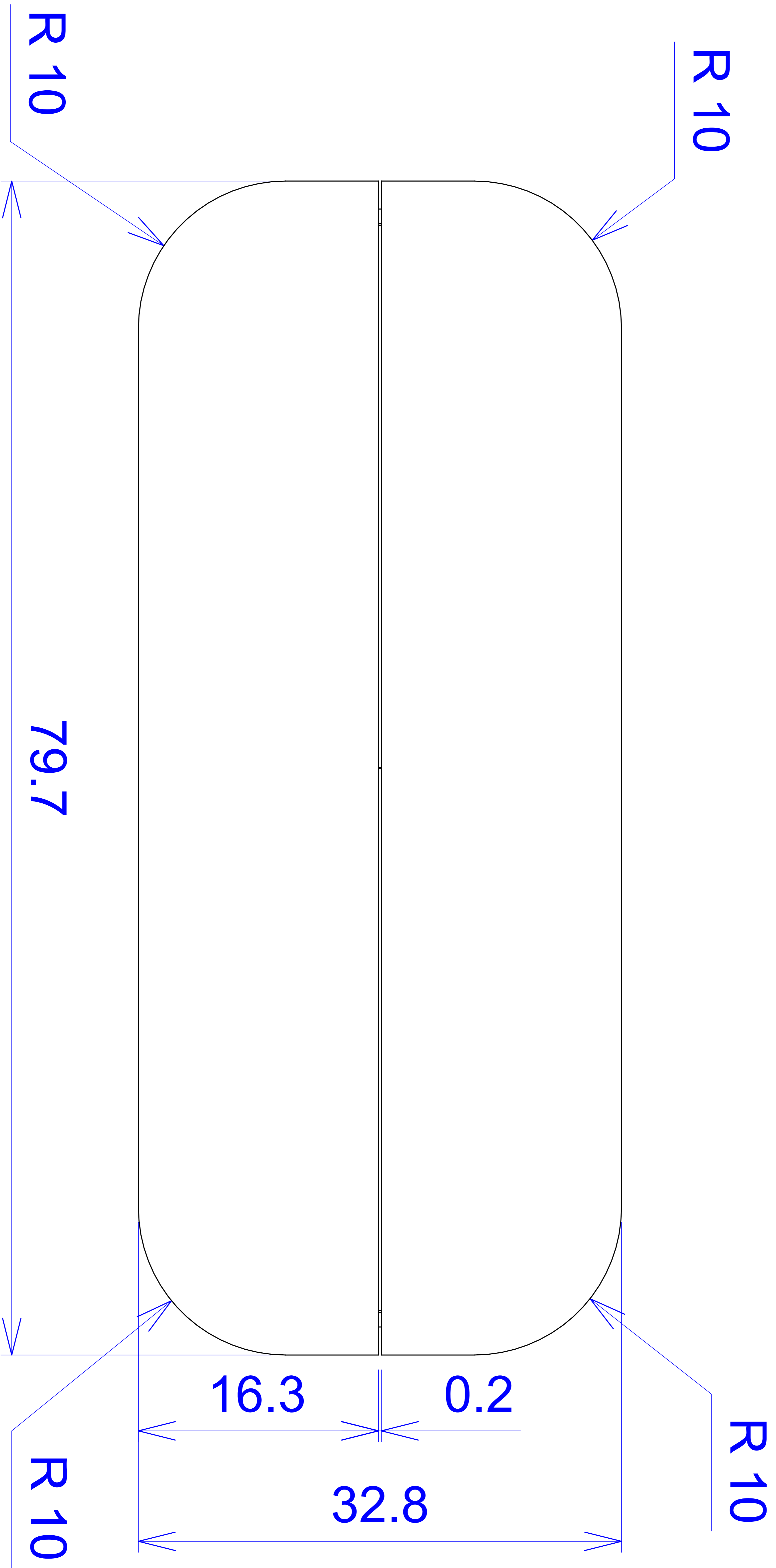

C - C

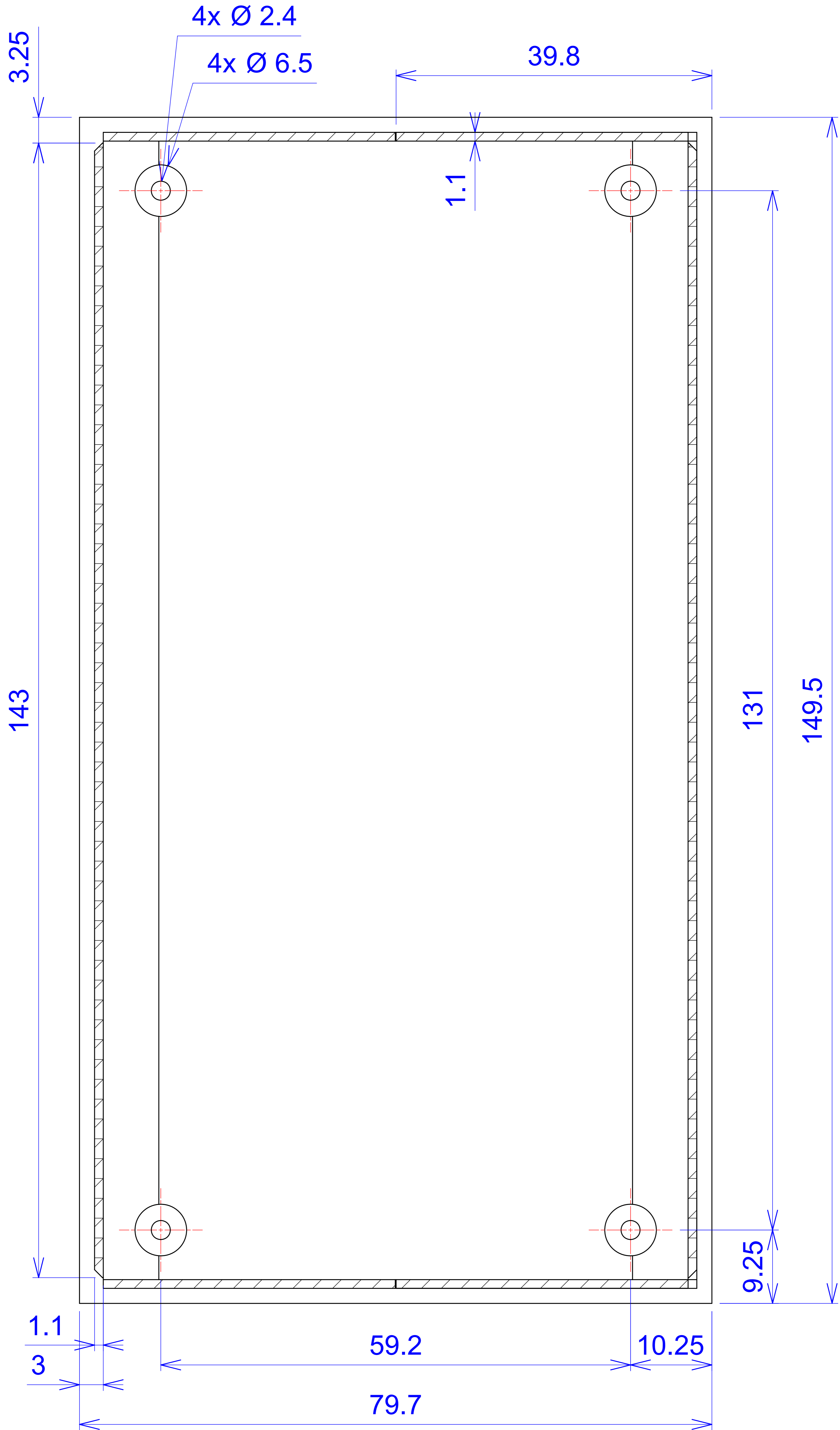

A

