

PRELIMINARY SPEC

Part Number: KAS-4805SELS/5

Hyper Orange

Features

- DIMENSION: 48mm X 5mm X 1.6mm.
- INSTANT LIGHT.
- LINEAR TYPE.
- HIGH EFFICIENCY.
- LONG OPERATING LIFE.
- LOW POWER CONSUMPTION.
- MORE ENERGY EFFICIENT THAN INCANDESCENT, MOST HALOGEN LAMPS, AND FLUORESCENT LAMP.
- RoHS COMPLIANT.

Description

The package containing fifteen chips is capable of providing high brightness.

High thermal dissipation efficiency is achieved by incorporating aluminium as reflector and also substrate to ensure long operating life.

The Hyper Orange device is made with TS AlInGaP light emitting diode.

Applications

- Ceiling lights.
- Contour lights.
- Decoration lights.
- General lighting.
- Architectural lighting.

Package Dimensions

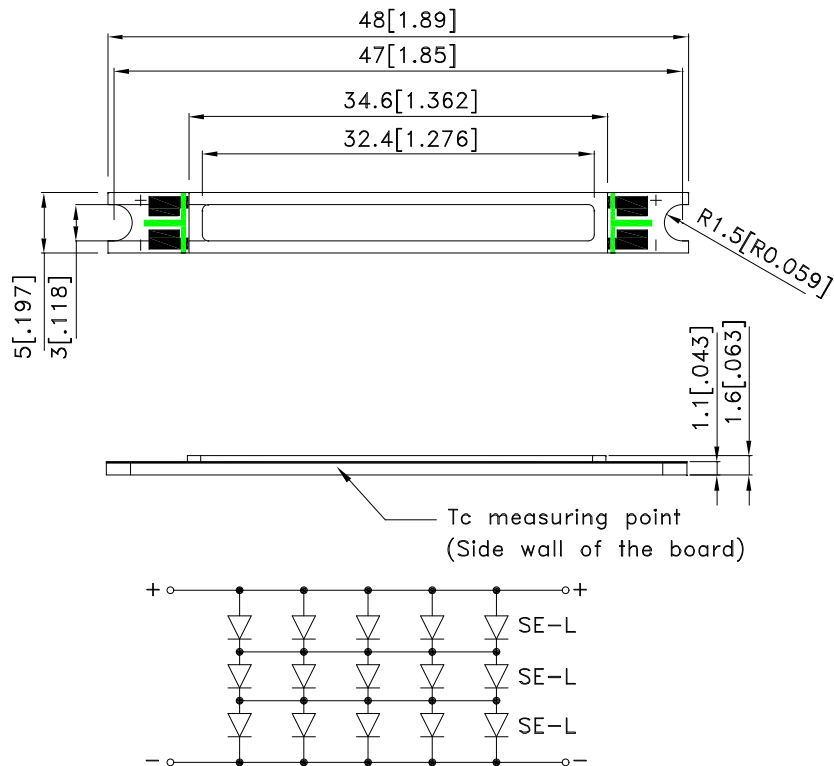

Notes:

1. All dimensions are in millimeters (inches).
2. Tolerance is $\pm 0.25(0.01)$ unless otherwise noted.
3. Specifications are subject to change without notice.



Handling Precautions

Compare to epoxy encapsulant that is hard and brittle, silicone is softer and flexible. Although its characteristic significantly reduces thermal stress, it is more susceptible to damage by external mechanical force.

As a result, special handling precautions need to be observed during assembly using silicone encapsulated LED products. Failure to comply might leads to damage and premature failure of the LED.

1. Do not directly touch or handle the silicone lens surface. It may damage the internal circuitry.

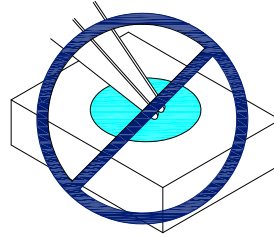
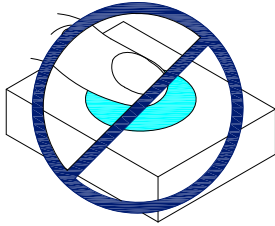

2. Do not stack together assembled PCBs containing exposed LEDs. Outside impact may scratch the silicone lens or damage the internal circuitry.

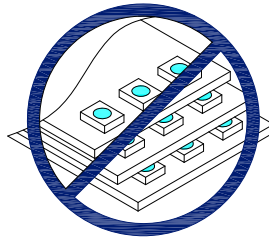

Absolute Maximum Ratings

Parameter	Symbol	Rating	Units
Forward Current	I _F	500	mA
Forward Pulse Current [1]	I _{FP}	700	mA
Power Dissipation	P _d	4.75	W
LED Junction Temperature	T _j	110	°C
Operating Temperature	T _{opr}	-30~+100	°C
Storage Temperature	T _{stg}	-40~+120	°C
Case Temperature	T _c	100	°C

Note:

1. 1/10 Duty Cycle, 0.1ms Pulse Width.

Electrical / Optical Characteristics

Part Name	Device	Parameter	Symbol	Min.	Typ.	Max.	Units	Conditions
KAS-4805SELS/5	Orange	Forward Voltage [2]	V _F	8.5	9	9.5	V	I _F =500mA
		Luminous Flux [3]	Φ _v	60	75	-	lm	I _F =500mA
		Wavelength at peak emission[4]	λ _{peak}	-	626	-	nm	I _F =500mA
		Dominant Wavelength	λ _{dom}	-	618	-	nm	I _F =500mA
		Spectral bandwidth at 50%Φ _{REL} MAX	Δλ _{1/2}	-	20	-	nm	I _F =500mA
		Temperature coefficient of λ _{peak}	TCλ _{peak}	-	0.11	-	nm/°C	I _F =500mA
		Temperature coefficient of λ _{dom}	TCλ _{dom}	-	0.09	-	nm/°C	I _F =500mA
		Temperature coefficient of Forward Voltage	ΔλV _F /ΔT	-	-3.8	-	mV/°C	I _F =500mA
		Thermal Resistance	R _{th j-c}	-	3.5	-	°C/W	I _F =500mA
		Emission Angle	2 θ 1/2 X direction	-	130	-	°	I _F =500mA
2 θ 1/2 Y direction	-		130	-	°	I _F =500mA		

Notes:

2. Forward Voltage is measured with an accuracy of +/-0.1V.

3. Flux is measured with an accuracy of +/-15%.

4. Wavelength : +/-0.1nm.

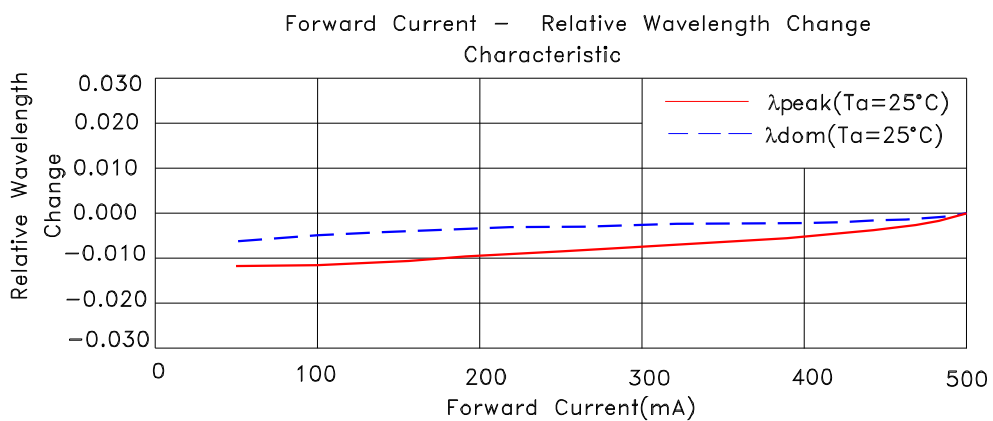
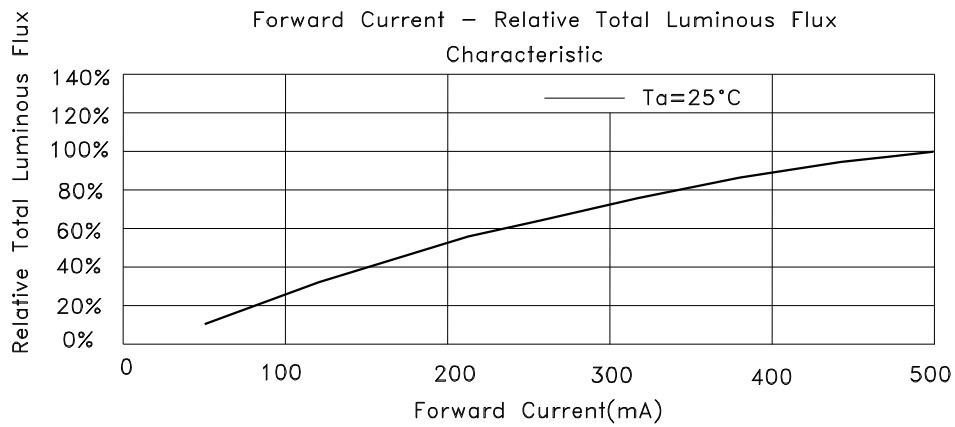
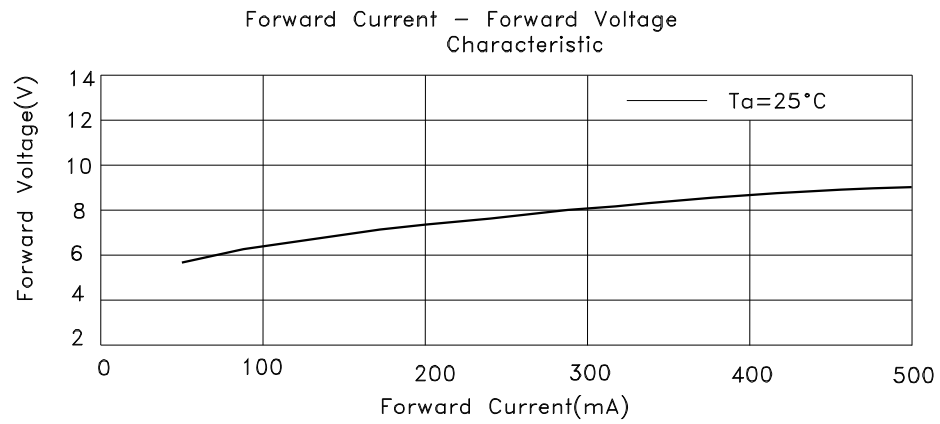

Ambient Temperature T_a – Forward Voltage Characteristic

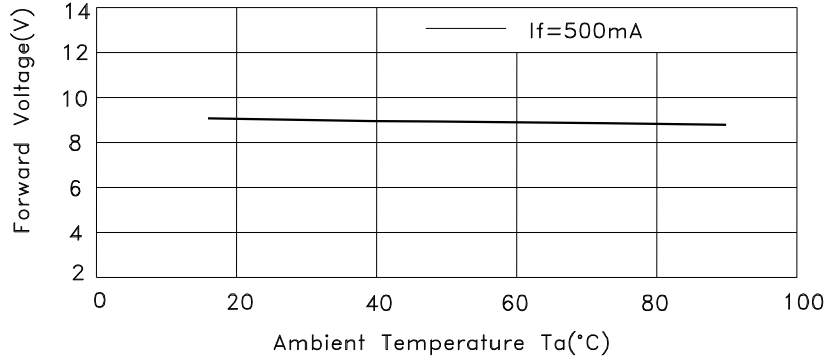

Ambient Temperature T_a – Relative Total Luminous Flux Characteristic

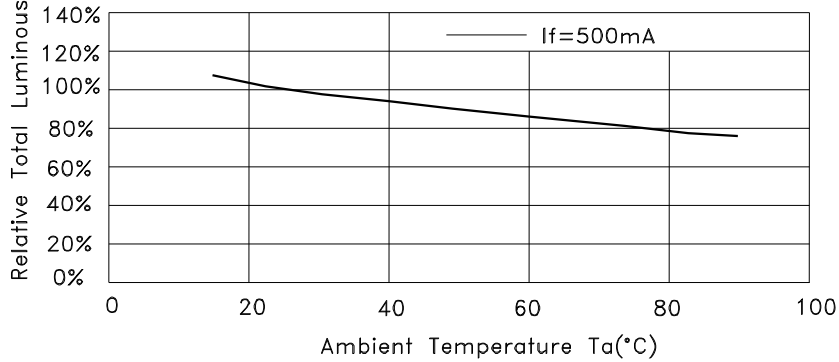

Ambient Temperature T_a – Relative Wavelength Change Characteristic

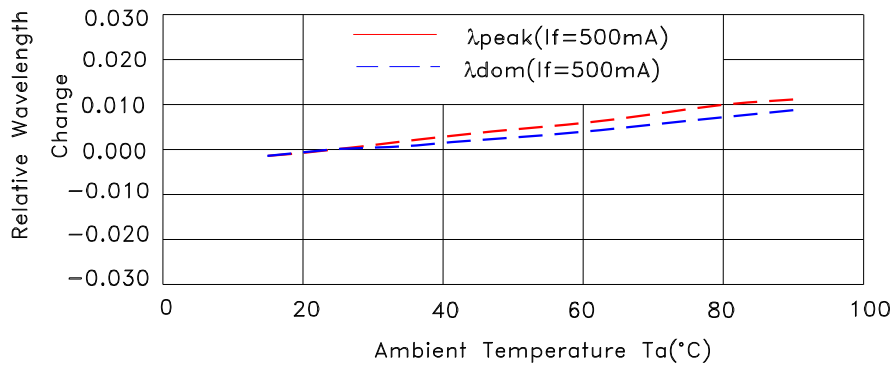

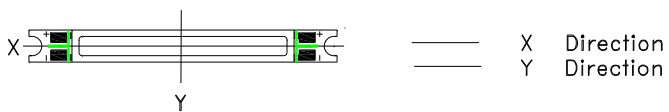
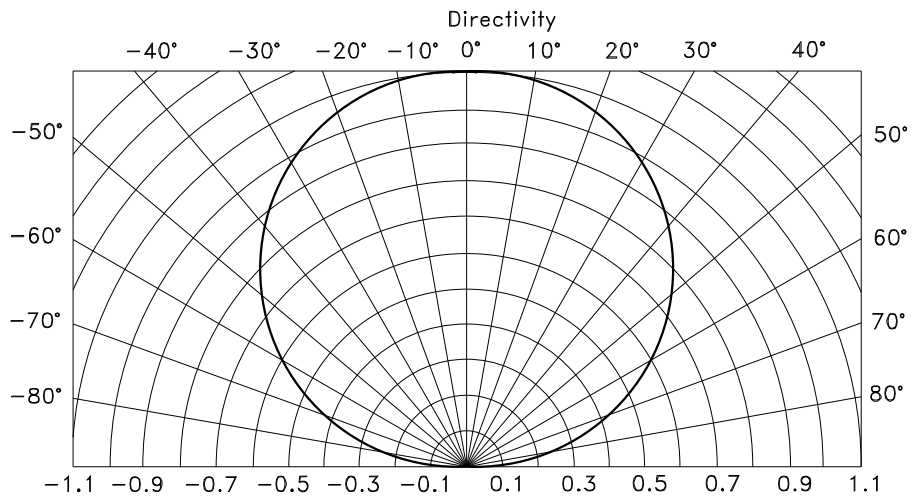
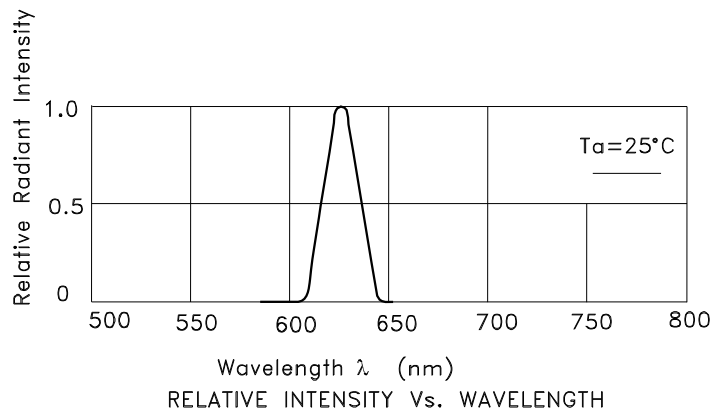
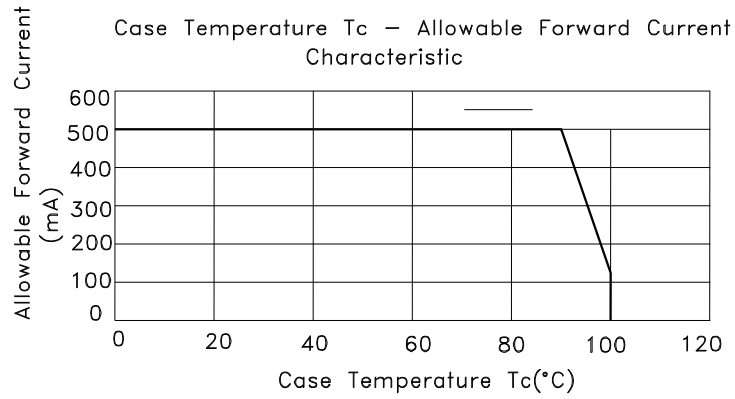

PACKING & LABEL SPECIFICATIONS

KAS-4805SELS/5

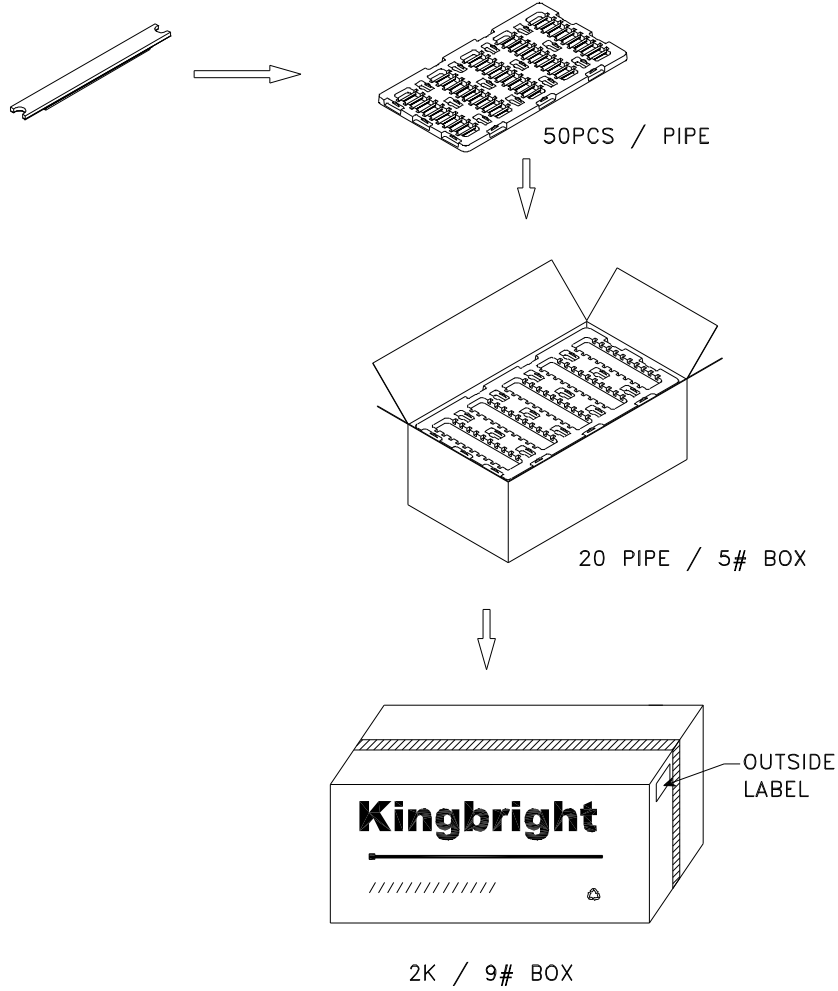

Kingbright	
Q.C.	QC XXX XX XXX PASSED
TYPE NO :KAS-4805XXX	
QUANTITY : 50 pcs	
S/N : XXX	CODE: XXX
LOT NO	RoHS Compliant
 XX-XXXX	