

HEXFET® Power MOSFET

V_{DSS}	60	V
V_{GS}	±16	V
$R_{DS(on) \max}$ (@ $V_{GS} = 10V$)	92	mΩ
$R_{DS(on) \max}$ (@ $V_{GS} = 4.5V$)	116	mΩ

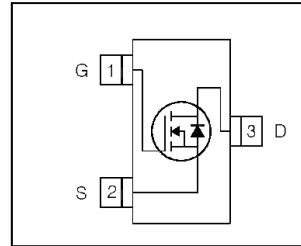

G	D	S
Gate	Drain	Source

Applications

- Load/System Switch

Features

Industry-Standard Pinout
Compatible with Existing Surface Mount Techniques
RoHS Compliant Containing no Lead, no Bromide and no Halogen
MSL1

Benefits

 results in
⇒

Multi-Vendor Compatibility
Easier Manufacturing
Environmentally Friendlier
Increased Reliability

Base part number	Package Type	Standard Pack		Orderable Part Number
		Form	Quantity	
IRLML0060TRPbF	Micro 3™ (SOT-23)	Tape and Reel	3000	IRLML0060TRPbF

Absolute Maximum Ratings

Symbol	Parameter	Max.	Units
V_{DS}	Drain-to-Source Voltage	60	V
$I_D @ T_A = 25^\circ C$	Continuous Drain Current, $V_{GS} @ 10V$	2.7	A
$I_D @ T_A = 70^\circ C$	Continuous Drain Current, $V_{GS} @ 10V$	2.1	
I_{DM}	Pulsed Drain Current	11	
$P_D @ T_A = 25^\circ C$	Maximum Power Dissipation	1.25	W
$P_D @ T_A = 70^\circ C$	Maximum Power Dissipation	0.80	
	Linear Derating Factor	0.01	mW/°C
V_{GS}	Gate-to-Source Voltage	± 16	
T_J T_{STG}	Operating Junction and Storage Temperature Range	-55 to + 150	°C

Thermal Resistance

Symbol	Parameter	Typ.	Max.	Units
$R_{\theta JA}$	Junction-to-Ambient ③	—	100	°C/W
$R_{\theta JA}$	Junction-to-Ambient (t < 10s) ④	—	99	

Electrical Characteristics @ T_J = 25°C (unless otherwise specified)

	Parameter	Min.	Typ.	Max.	Units	Conditions
V _{(BR)DSS}	Drain-to-Source Breakdown Voltage	60	—	—	V	V _{GS} = 0V, I _D = 250μA
ΔV _{(BR)DSS} /ΔT _J	Breakdown Voltage Temp. Coefficient	—	0.06	—	V/°C	Reference to 25°C, I _D = 1mA
R _{DS(on)}	Static Drain-to-Source On-Resistance	—	98	116	mΩ	V _{GS} = 4.5V, I _D = 2.2A
		—	78	92		V _{GS} = 10V, I _D = 2.7A
V _{GS(th)}	Gate Threshold Voltage	1.0	—	2.5	V	V _{DS} = V _{GS} , I _D = 25μA
I _{DSS}	Drain-to-Source Leakage Current	—	—	20	μA	V _{DS} = 60V, V _{GS} = 0V
		—	—	250		V _{DS} = 60V, V _{GS} = 0V, T _J = 125°C
I _{GSS}	Gate-to-Source Forward Leakage	—	—	100	nA	V _{GS} = 16V
	Gate-to-Source Reverse Leakage	—	—	-100		V _{GS} = -16V
R _G	Internal Gate Resistance	—	1.6	—	Ω	
g _{fs}	Forward Trans conductance	7.6	—	—	S	V _{DS} = 25V, I _D = 2.7A
Q _g	Total Gate Charge	—	2.5	—	nC	I _D = 2.7A
Q _{gs}	Gate-to-Source Charge	—	0.7	—		V _{DS} = 30V
Q _{gd}	Gate-to-Drain ('Miller') Charge	—	1.3	—		V _{GS} = 4.5V ②
t _{d(on)}	Turn-On Delay Time	—	5.4	—	ns	V _{DD} = 30V ②
t _r	Rise Time	—	6.3	—		I _D = 1.0A
t _{d(off)}	Turn-Off Delay Time	—	6.8	—		R _G = 6.8Ω
t _f	Fall Time	—	4.2	—		V _{GS} = 4.5V
C _{iss}	Input Capacitance	—	290	—	pF	V _{GS} = 0V
C _{oss}	Output Capacitance	—	37	—		V _{DS} = 25V
C _{rss}	Reverse Transfer Capacitance	—	21	—		f = 1.0MHz

Source-Drain Ratings and Characteristics

	Parameter	Min.	Typ.	Max.	Units	Conditions
I _S	Continuous Source Current (Body Diode)	—	—	1.6	A	MOSFET symbol showing the integral reverse p-n junction diode. 
I _{SM}	Pulsed Source Current (Body Diode) ①	—	—	11		
V _{SD}	Diode Forward Voltage	—	—	1.3	V	T _J = 25°C, I _S = 2.7A, V _{GS} = 0V ②
t _{rr}	Reverse Recovery Time	—	14	21	ns	T _J = 25°C, V _R = 30V, I _F = 1.6A
Q _{rr}	Reverse Recovery Charge	—	13	20	nC	di/dt = 100A/μs ②

Notes:

- ① Repetitive rating; pulse width limited by max. junction temperature.
- ② Pulse width ≤ 400μs; duty cycle ≤ 2%.
- ③ Surface mounted on 1 in square Cu board
- ④ Refer to application note #AN-994.

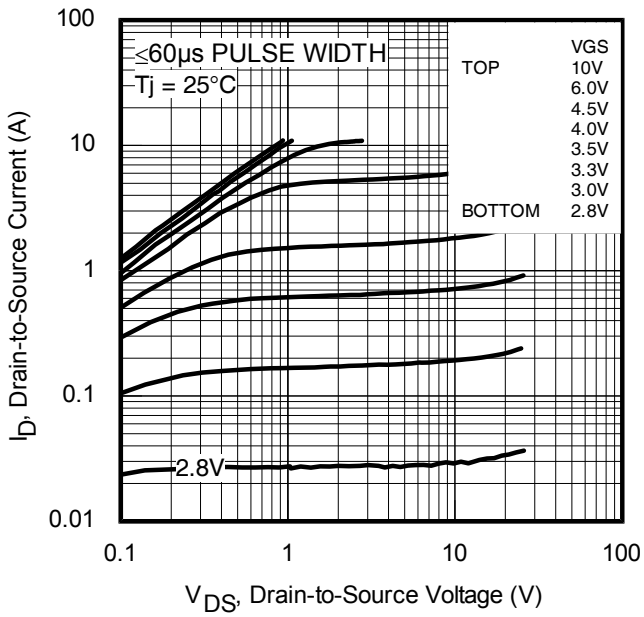
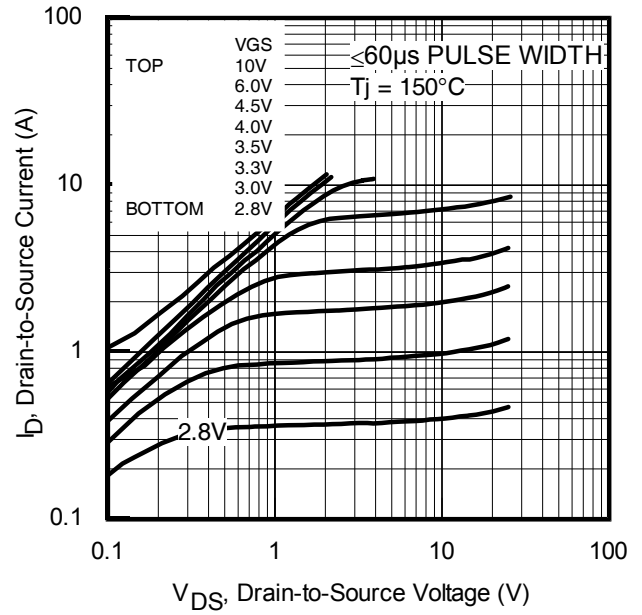
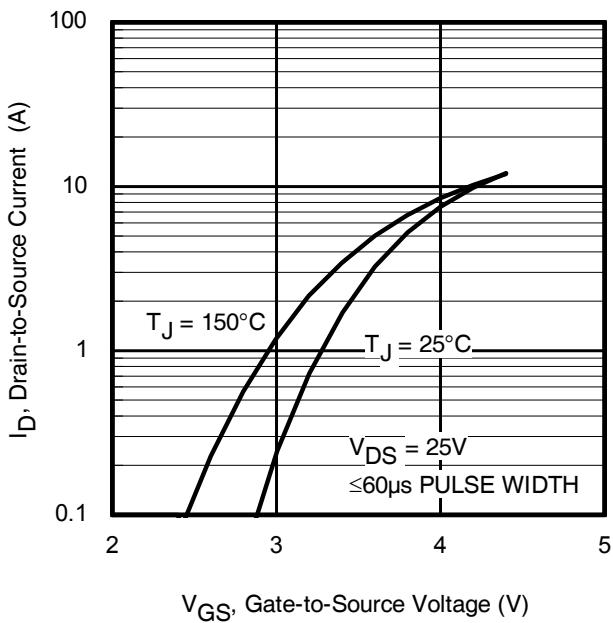
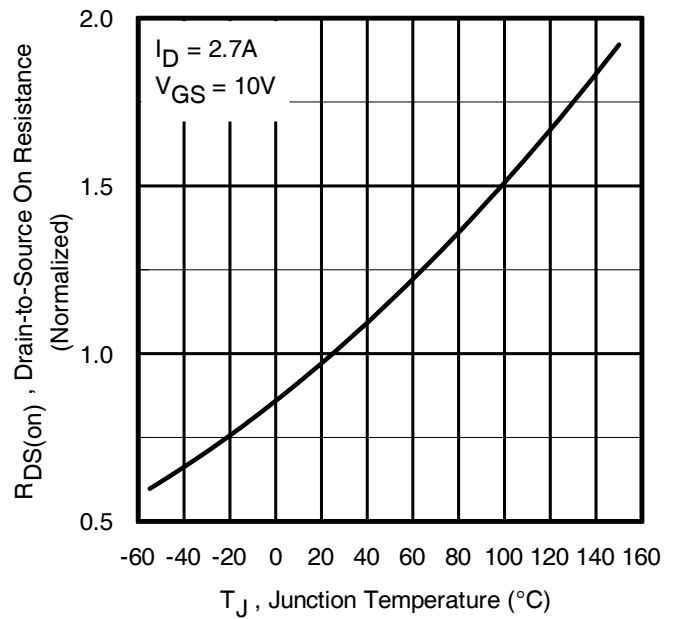
Fig. 1 Typical Output Characteristics

Fig. 2 Typical Output Characteristics

Fig. 3 Typical Transfer Characteristics

Fig. 4 Normalized On-Resistance vs. Temperature

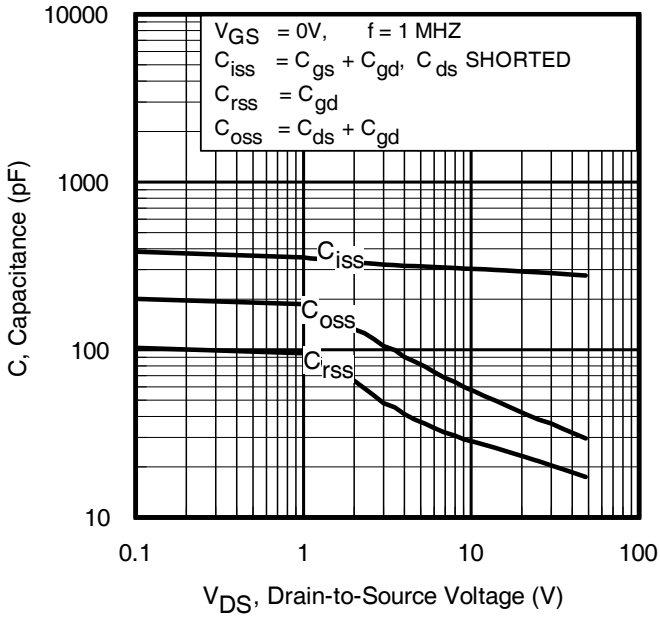

Fig 5. Typical Capacitance vs. Drain-to-Source Voltage

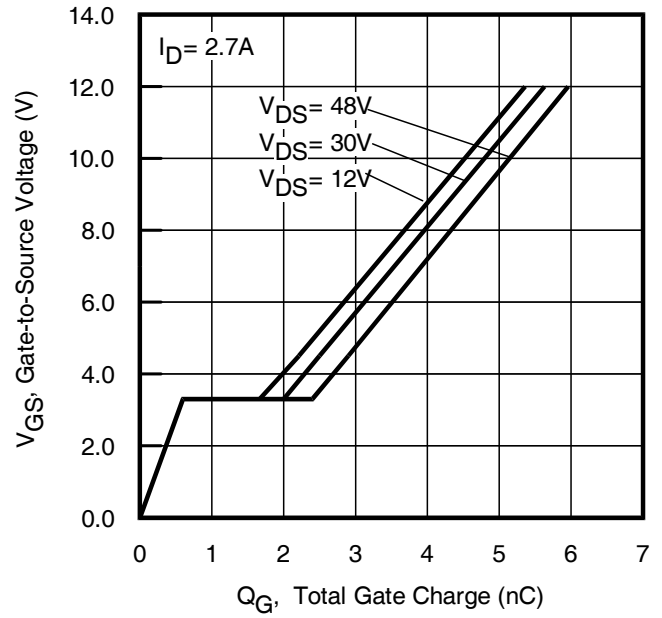

Fig 6. Typical Gate Charge vs. Gate-to-Source Voltage

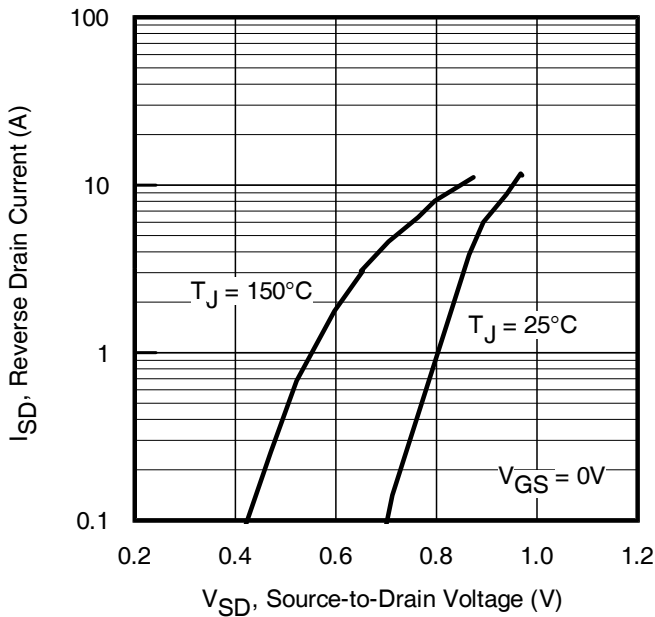

Fig 7 Typical Source-to-Drain Diode Forward Voltage

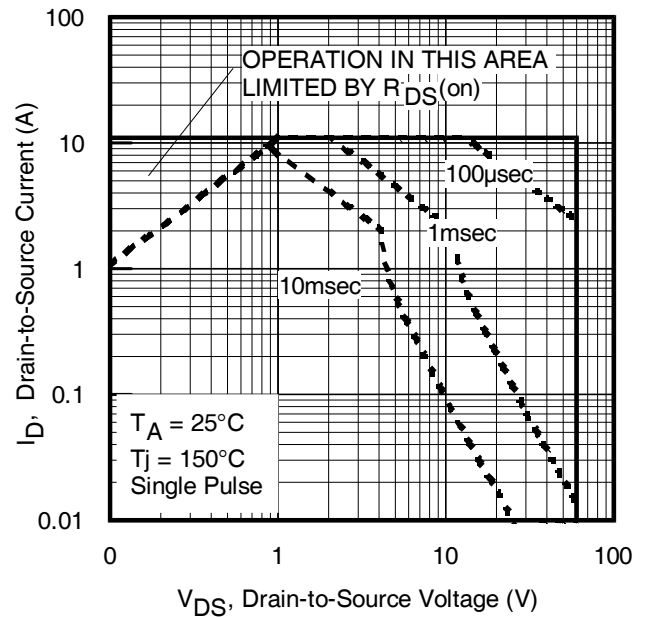

Fig 8. Maximum Safe Operating Area

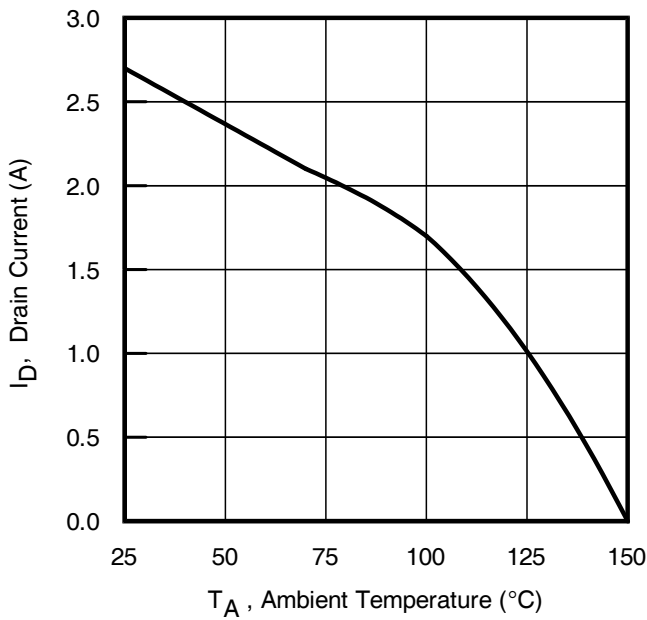

Fig 9. Maximum Drain Current vs. Case Temperature

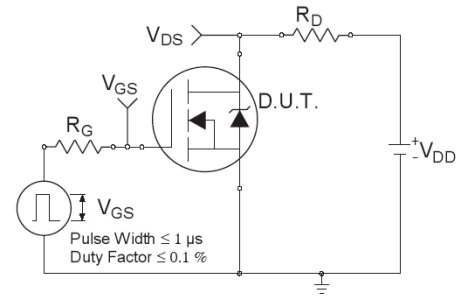

Fig 10a. Switching Time Test Circuit

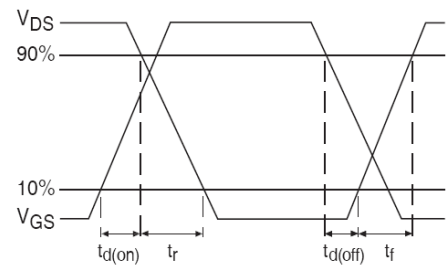

Fig 10b. Switching Time Waveforms

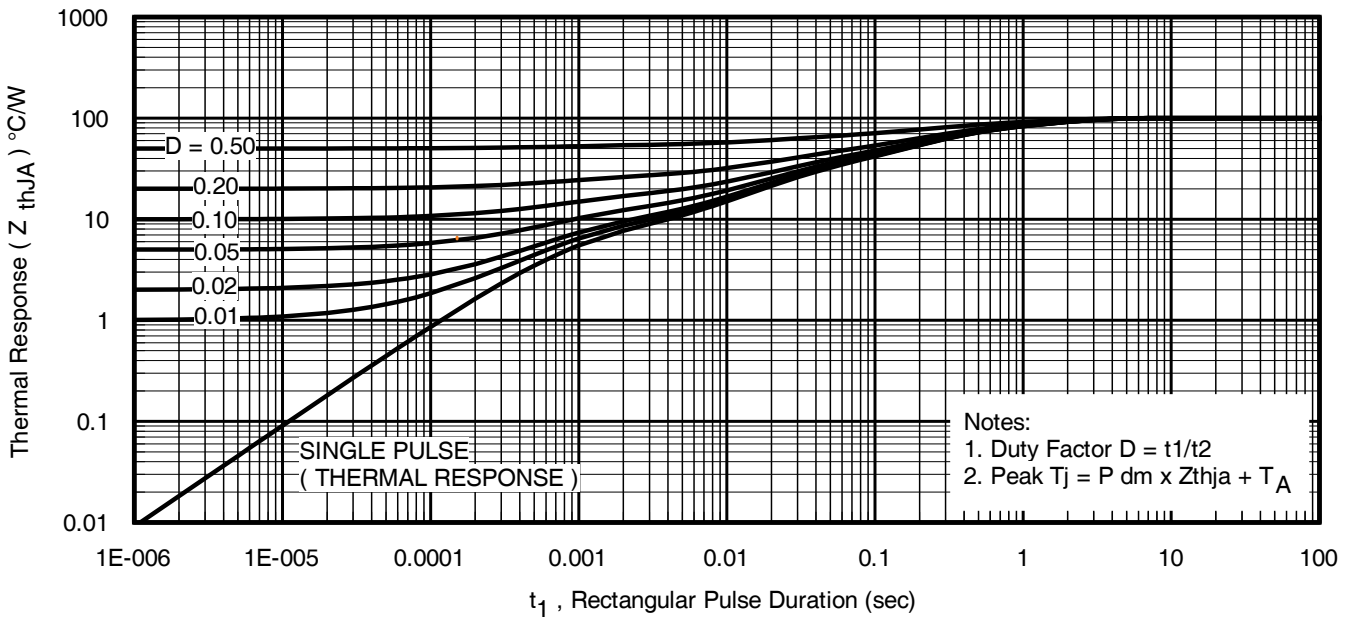

Fig 11. Maximum Effective Transient Thermal Impedance, Junction-to-Ambient

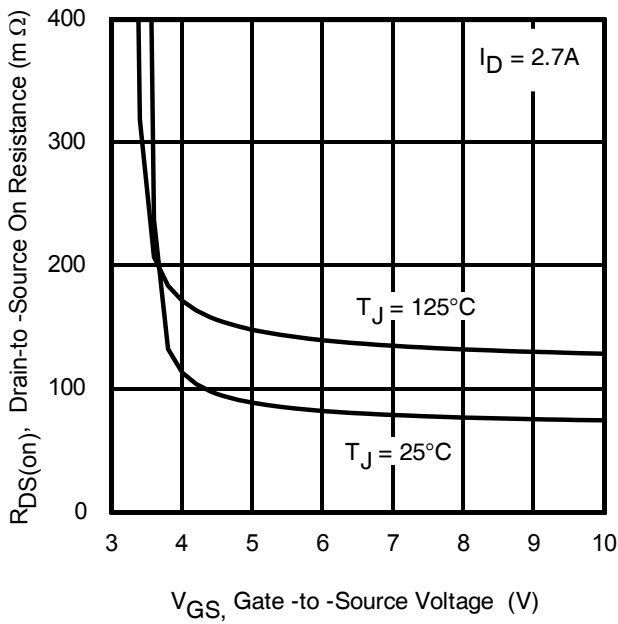

Fig 12. Typical On-Resistance Vs. Gate Voltage

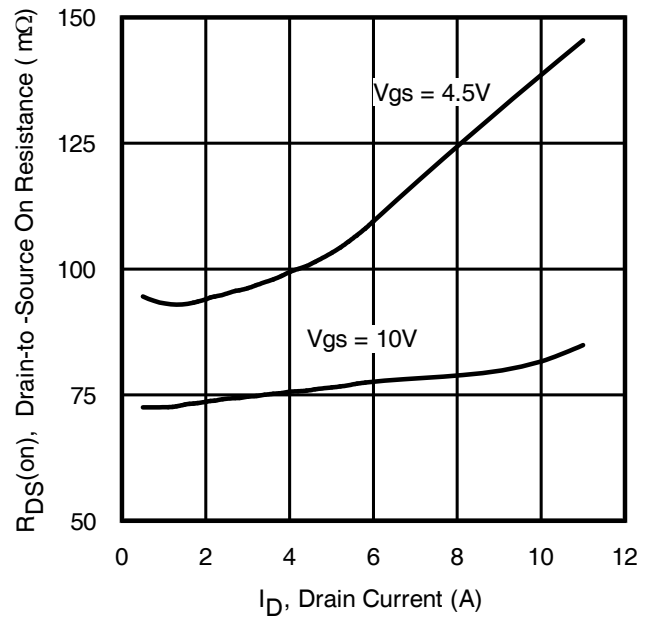

Fig 13. Typical On-Resistance Vs. Drain Current

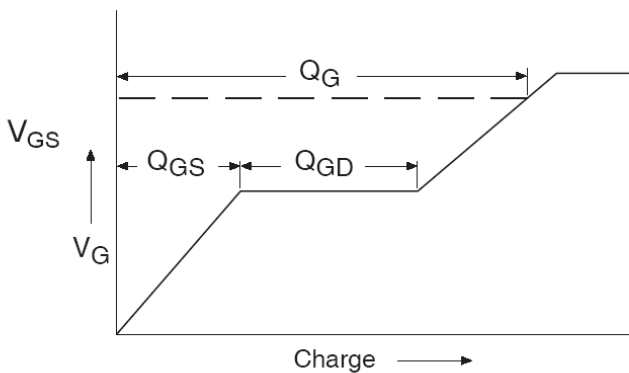

Fig 14a. Basic Gate Charge Waveform

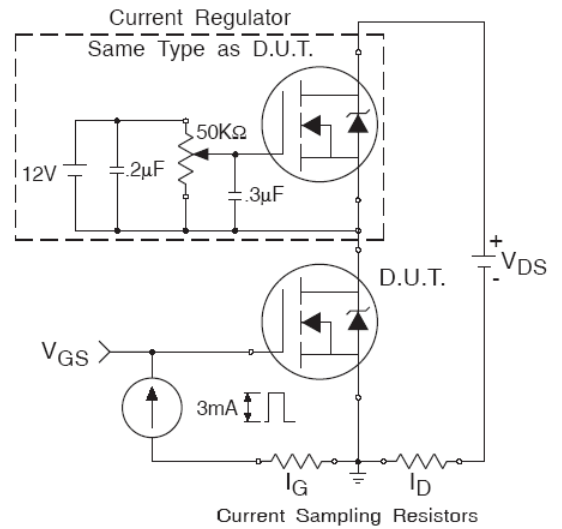

Fig 14b. Gate Charge Test Circuit

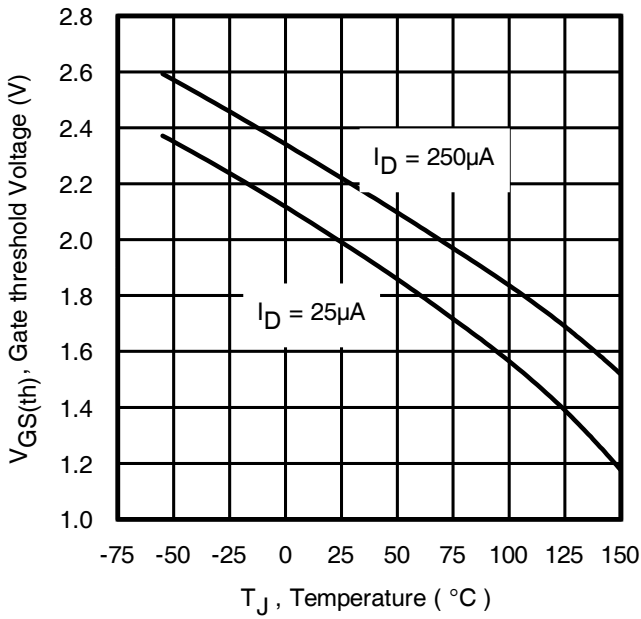

Fig 15. Typical Threshold Voltage Vs. Junction Temperature

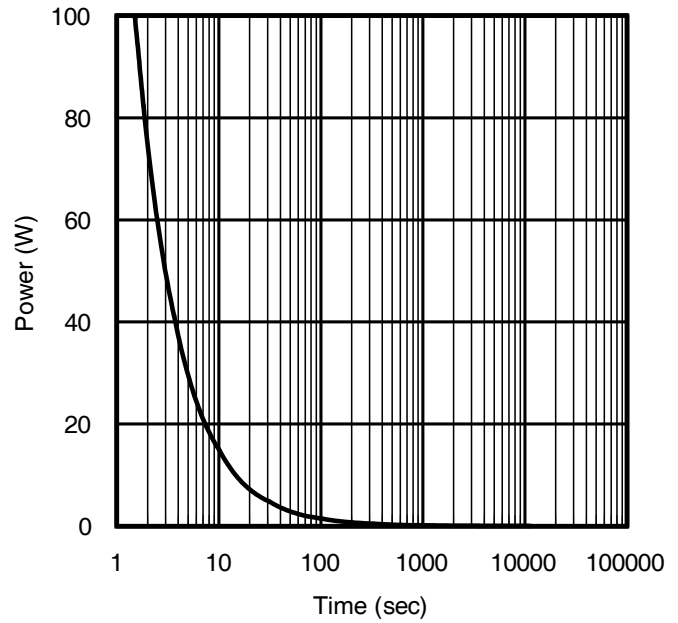
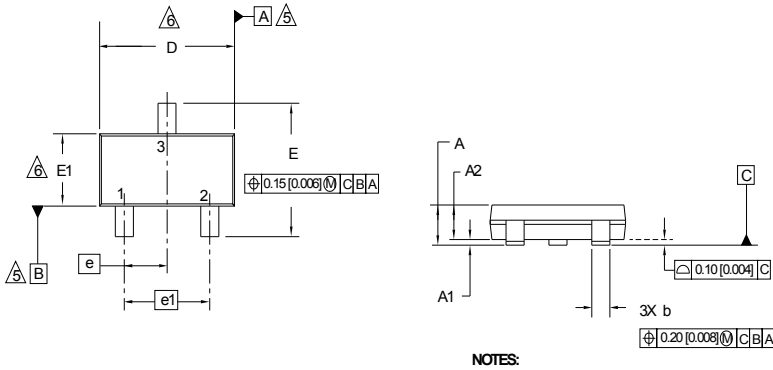
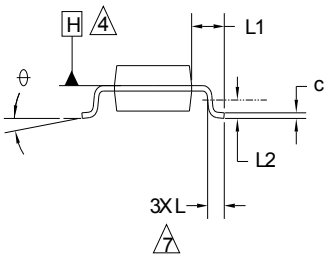
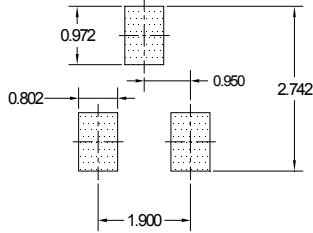

Fig 16. Typical Power Vs. Time

Micro3™ (SOT-23) Package Outline (Dimensions are shown in millimeters (inches))

NOTES:

SYMBOL	MILLIMETERS		INCHES	
	MIN	MAX	MIN	MAX
A	0.89	1.12	0.035	0.044
A1	0.01	0.10	0.0004	0.004
A2	0.88	1.02	0.035	0.040
b	0.30	0.50	0.012	0.020
c	0.08	0.20	0.003	0.008
D	2.80	3.04	0.110	0.120
E	2.10	2.64	0.083	0.104
E1	1.20	1.40	0.047	0.055
e	0.95	BSC	0.037	BSC
e1	1.90	BSC	0.075	BSC
L	0.40	0.60	0.016	0.024
L1	0.54	REF	0.021	REF
L2	0.25	BSC	0.010	BSC
⌀	0	8	0	8

Recommended Footprint

NOTES:

1. DIMENSIONING & TOLERANCING PER ANSI Y14.5M-1994
2. DIMENSIONS ARE SHOWN IN MILLIMETERS (INCHES).
3. CONTROLLING DIMENSION: MILLIMETER
4. DATUM PLANE H IS LOCATED AT THE MOLD PARTING LINE
5. DATUM A AND B TO BE DETERMINED AT DATUM PLANE H
6. DIMENSIONS D AND E1 ARE MEASURED AT DATUM PLANE H. DIMENSIONS DOES NOT INCLUDE MOLD PROTRUSIONS OR INTERLEAD FLASH. MOLD PROTRUSIONS OR INTERLEAD FLASH SHALL NOT EXCEED 0.25 MM (0.010 INCH) PER SIDE
7. DIMENSION L IS THE LEAD LENGTH FOR SOLDERING TO A SUBSTRATE
8. OUTLINE CONFORMS TO JEDEC OUTLINE TO-236 AB

Micro3™ (SOT-23/TO-236AB) Part Marking Information

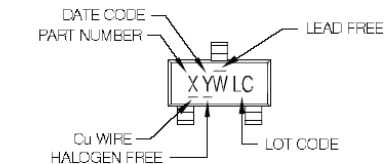
Notes: This part marking information applies to devices produced after 02/26/2001

X = PART NUMBER CODE REFERENCE:

A = IRLML2402	S = IRLML8244
B = IRLML2803	T = IRLML6246
C = IRLML6302	U = IRLML6344
D = IRLML5103	V = IRLML6346
E = IRLML6402	W = IRLML8244
F = IRLML6401	X = IRLML2244
G = IRLML2602	Y = IRLML2246
H = IRLML6203	Z = IRLML9244
I = IRLML0030	
J = IRLML2030	
K = IRLML0100	
L = IRLML0060	
M = IRLML0040	
N = IRLML2060	
P = IRLML9301	
R = IRLML9303	

Note: A line above the work week (as shown here) indicates Lead - Free.

DATE CODE MARKING INSTRUCTIONS

WW = (1-26) IF PRECEDED BY LAST DIGIT OF CALENDAR YEAR

YEAR	Y	WORK WEEK	W
2011	2001	01	A
2012	2002	02	B
2013	2003	03	C
2014	2004	04	D
2015	2005	05	
2016	2006	06	
2017	2007	07	
2018	2008	08	
2019	2009	09	
2020	2010	24	X
		25	Y
		26	Z

WW = (27-52) IF PRECEDED BY A LETTER

YEAR	Y	WORK WEEK	W
2011	2001	A 27	A
2012	2002	B 28	B
2013	2003	C 29	C
2014	2004	D 30	D
2015	2005	E	
2016	2006	F	
2017	2007	G	
2018	2008	H	
2019	2009	J	
2020	2010	K 50	X
		51	Y
		52	Z

 Note: For the most current drawing please refer to Infineon's web site www.infineon.com

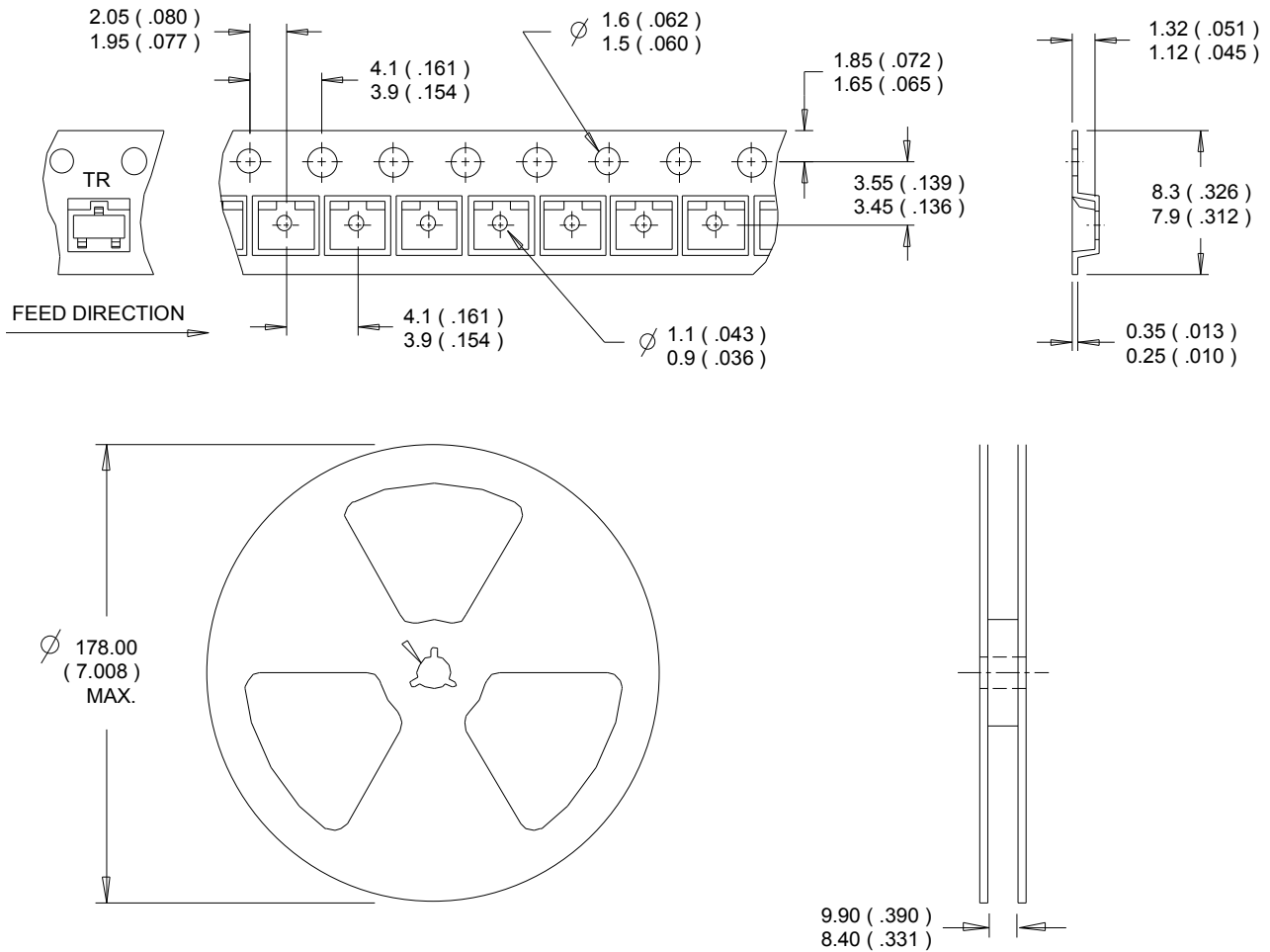
Micro3™ Tape & Reel Information (Dimensions are shown in millimeters (inches))

- NOTES:
1. CONTROLLING DIMENSION : MILLIMETER.
 2. OUTLINE CONFORMS TO EIA-481 & EIA-541.

Note: For the most current drawing please refer to Infineon's web site www.infineon.com

Qualification Information

Qualification Level	Consumer (per JEDEC JESD47F) †	
Moisture Sensitivity Level	Micro3™ (SOT-23)	MSL1 (per JEDEC J-STD-020D) †
RoHS Compliant	Yes	

† Applicable version of JEDEC standard at the time of product release.

Revision History

Date	Comments
12/20/16	<ul style="list-style-type: none"> Changed datasheet with Infineon logo - all pages. Removed typo "Industrial" on Feature and Benefits Table on page1. Corrected typo for Igss test condition from "V_{GS} = 20V" to "V_{GS} = 16V" on page 2.

Trademarks of Infineon Technologies AG

μHVIC™, μIPM™, μPFC™, AU-ConvertIR™, AURIX™, C166™, CanPAK™, CIPOS™, CIPURSE™, CoolDP™, CoolGaN™, COOLiR™, CoolMOST™, CoolSET™, CoolSiC™, DAVE™, DI-POL™, DirectFET™, DrBlade™, EasyPIM™, EconoBRIDGE™, EconoDUAL™, EconoPACK™, EconoPIM™, EiceDRIVER™, eupec™, FCOS™, GaNpowIR™, HEXFET™, HITFET™, HybridPACK™, iMOTION™, IRAM™, ISOFACE™, IsoPACK™, LEDrivIR™, LITIX™, MIPAQ™, ModSTACK™, my-d™, NovalithIC™, OPTIGA™, OptiMOST™, ORIGA™, PowIRaudio™, PowIRStage™, PrimePACK™, PrimeSTACK™, PROFET™, PRO-SiL™, RASiC™, REAL3™, SmartLEWIS™, SOLID FLASH™, SPOC™, StrongIRFET™, SupIRBuck™, TEMPFET™, TRENCHSTOP™, TriCore™, UHVIC™, XHP™, XMC™

Trademarks updated November 2015

Other Trademarks

All referenced product or service names and trademarks are the property of their respective owners.

Edition 2016-04-19

Published by
Infineon Technologies AG
81726 Munich, Germany

© 2016 Infineon Technologies AG.
All Rights Reserved.

Do you have a question about this document?
Email: erratum@infineon.com

Document reference
ifx1

IMPORTANT NOTICE

The information given in this document shall in no event be regarded as a guarantee of conditions or **characteristics ("Beschaffheitsgarantie")**.

With respect to any examples, hints or any typical values stated herein and/or any information regarding the application of the product, Infineon Technologies hereby disclaims any and all warranties and liabilities of any kind, including without limitation warranties of non-infringement of intellectual property rights of any third party.

In addition, any information given in this document **is subject to customer's compliance with its obligations** stated in this document and any applicable legal requirements, norms and standards concerning customer's products and any use of the product of Infineon Technologies in **customer's applications**.

The data contained in this document is exclusively intended for technically trained staff. It is the **responsibility of customer's technical departments** to evaluate the suitability of the product for the intended application and the completeness of the product information given in this document with respect to such application.

For further information on the product, technology, delivery terms and conditions and prices please contact your nearest Infineon Technologies office (www.infineon.com).

Please note that this product is not qualified according to the AEC Q100 or AEC Q101 documents of the Automotive Electronics Council.

WARNINGS

Due to technical requirements products may contain dangerous substances. For information on the types in question please contact your nearest Infineon Technologies office.

Except as otherwise explicitly approved by Infineon Technologies in a written document signed by authorized representatives of Infineon Technologies, **Infineon Technologies' products may not be used** in any applications where a failure of the product or any consequences of the use thereof can reasonably be expected to result in personal injury.